



HEARING NOTICE

LAND USE REQUEST AFFECTING THIS AREA

There is a development proposal for the property listed in this notice and shown on the attached map. The City is seeking input from neighbors on the proposal. If you have questions or comments about the proposal, contact the case manager.

Esta carta es un aviso sobre una propuesta de desarrollo para la propiedad enumerada y que se muestra en el mapa adjunto. La ciudad está buscando la opinión de los vecinos sobre la propuesta. Si tiene preguntas o comentarios sobre la propuesta, póngase en contacto con nosotros al 503-588-6213

CASE NUMBER:	APPEAL of Urban Growth Preliminary Declaration / Class 3 Site Plan Review / Class 2 Adjustment / Class 1 Adjustment / Class 2 Driveway Approach Permit / Class 1 Design Review / Property Line Adjustment Case No. UGA-SPR-ADJ-DAP-DR-PLA24-03
PROPERTY LOCATION:	4650 Hazelgreen Road NE, Salem OR 97305
PROPOSAL SUMMARY:	Appeal of the Planning Administrator's Decision to approve a proposed development of a new 405-unit multi-family residential development containing 33 residential buildings.
HEARING INFORMATION:	<u>CITY COUNCIL, Monday, May 13, 2024, at 6:00 p.m., Council Chambers, Room 240, Civic Center, 555 Liberty Street SE, Salem, OR 97301</u> Interested persons may view the meeting online at City of Salem Facebook, CCTV Salem, You Tube Channel, or watch on Comcast Cable CCTV Channel 21.
HOW TO PROVIDE TESTIMONY:	Both written and oral testimony will be accepted on this proposal. Only those participating by submitting written testimony, or by testifying at the hearing, have the right to appeal the decision. Any person wishing to speak either for or against the proposed request may do so in person or by representative at the Public Hearing. Written comments may also be submitted at the Public Hearing. Include case number with the written comments. Prior to the Public Hearing, written comments may be filed with the City Recorder, 555 Liberty Street SE, Room 225, Salem, OR 97301 or by emailing cityrecorder@cityofsalem.net . If unable to attend the meeting in person but would like to provide testimony via Zoom, please sign up between 8:00 a.m. and 4:00 p.m. on the day of the meeting at the following link: https://www.cityofsalem.net/comment-at-council .
CASE MANAGER:	Aaron Panko, Planner III , City of Salem Planning Division, 555 Liberty Street SE, Room 305, Salem, Oregon 97301. Telephone: 503-540-2356; E-mail: apanko@cityofsalem.net .
STAFF REPORT:	A copy of the staff report will be available no later than 5:00 p.m., May 6, 2024; copies can be requested from the Planning Division at 503-588-6173. The staff report will also be available online no later than 5:00 p.m., May 8, 2024 at: https://salem.legistar.com/Calendar.aspx
ACCESS:	The Americans with Disabilities Act (ADA) accommodations will be provided on request.
OWNER(S):	North Place Apartments Phase 2 LLC, represented by Kiril Ivanov and Patricia Jones.

APPLICANT / AGENT(S):

AKS Engineering and Forestry

NEIGHBORHOOD ASSOCIATION:

Neighborhood associations (N.A.) are volunteer organizations of neighbors coming together to make neighborhoods the best they can be. They receive notice of land use applications within their boundaries, and they often submit comments on the applications to the City. Neighborhood association meetings are open to everyone. Contact your neighborhood association to get involved:

Northgate Neighborhood Association; Email:
northgateneighborhoodsalem@gmail.com.

PROPOSAL REQUEST:

Appeal of the Planning Administrator's Decision to approve an Urban Growth Area Preliminary Declaration to determine the public facilities required to serve the subject property, a Class 3 Site Plan Review and Class 1 Design Review for the development of a new 405-unit multi-family residential development, Class 2 Driveway Approach Permits for four new driveway approaches on proposed Lunar Drive NE, a Property Line Adjustment to eliminate an interior lot line, and the following Adjustments:

- 1) Class 1 Adjustment to reduce the setback requirement for Buildings 1 and 2 adjacent to a Hazelgreen Road NE from 20 feet per SRC 514.010(d), Table 514-4, to 16 feet;
- 2) Class 2 Adjustment to reduce the vehicle use area setback adjacent to Lunar Drive NE for one parking space near Building 33 from 12 feet per SRC 514.010(d), Table 514-4, to 6.2 feet;
- 3) Class 2 Adjustment to reduce the setback requirement for Building 33 adjacent to a Lunar Drive NE from 20 feet per SRC 514.010(d), Table 514-4, to approximately 12 feet;
- 4) Class 2 Adjustment to increase the maximum setback allowance adjacent to a street for Buildings 3, 4, and 5 from 10 feet per SRC 533.015(c), Table 533-3, to 16 feet;
- 5) Class 2 Adjustment to adjust the fencing and tree planting requirements of SRC 702.020(b)(2) along the southern boundary where the subject property abuts a BPA (Bonneville Power Administration) easement;
- 6) Class 2 Adjustment to reduce the tree planting requirement of SRC 702.020(b)(7) around the perimeter of the parking lot;
- 7) Class 2 Adjustment to eliminate the window requirement of SRC 702.020(c)(1) in certain habitable rooms of Buildings 11, ~~47, 26,~~ 14, 30, and 32; and
- 8) Class 2 Adjustment to reduce the setback requirement for Buildings 26 and 27 adjacent to a RS (Single Family Residential) zone from approximately 35 feet per SRC 702.020(e)(2), Table 702-5, to approximately 22 feet.

The subject property is approximately 15.6 acres in size, zoned MU-I (Mixed Use-I) and RM-II (Multi-Family Residential), and located at 4650 Hazelgreen Road NE – 97305 (Marion County Assessor's map and tax lot numbers: 062W32C / 000400 and 000500).

CRITERIA:

Salem Revised Code (SRC) Chapters 200.025 – Urban Growth Boundary; 220.005(f)(3) – Class 3 Site Plan Review; 250.005(d)(1) and (2) – Class 2 and Class 1 Adjustment; 804.025(d) – Class 2 Driveway Approach Permit; 225.005(e)(1) – Class 1 Design Review; 205.055(d) – Property Line Adjustment

MORE INFORMATION:

Salem Revised Code (SRC) is available to view at this link: <http://bit.ly/salemorcode>. Type in the chapter number(s) listed above to view the applicable criteria. All documents and evidence submitted by the applicant are available on the City's online Permit Application Center at <https://permits.cityofsalem.net>. You can use the search function without registering and enter the permit number listed here: 23 121805. Paper copies can be obtained for a reasonable cost.

HEARING PROCEDURE:

The hearing will be conducted with the staff presentation first, followed by the applicant's case, neighborhood association comments, persons in favor or opposition, and rebuttal by the applicant, if necessary. The applicant has the burden of proof to show that the approval criteria can be satisfied by the facts. Opponents may rebut the applicant's testimony by showing alternative facts or by showing that the evidence submitted does not satisfy the approval criteria.

Failure to raise an issue prior to the close of the Public Hearing in person or in writing, or failure to provide statements or evidence with sufficient specificity to provide the applicant and Review Authority to respond to the issue, precludes appeal to the Land Use Board of Appeals (LUBA) on this issue. A similar failure to raise constitutional issues relating to proposed conditions of approval precludes an action for damages in circuit court.

Following the close of the Public Hearing, a decision will be issued and mailed to the applicant, property owner, affected neighborhood associations, anyone who participated in the hearing, either in person or in writing, and anyone who requested to receive notice of the decision.

NOTICE MAILING DATE:

April 22, 2024

**PLEASE PROMPTLY FORWARD A COPY OF THIS NOTICE TO ANY OTHER OWNER, TENANT OR LESSEE.
For more information about Planning in Salem: <http://www.cityofsalem.net/planning>**

It is the City of Salem's policy to assure that no person shall be discriminated against on the grounds of race, religion, color, sex, marital status, familial status, national origin, age, mental or physical disability, sexual orientation, gender identity and source of income, as provided by Salem Revised Code Chapter 97. The City of Salem also fully complies with Title VI of the Civil Rights Act of 1964, and related statutes and regulations, in all programs and activities. Disability-related modification or accommodation, including auxiliary aids or services, in order to participate in this meeting or event, are available upon request. Sign language and interpreters for languages other than English are also available upon request. To request such an accommodation or interpretation, contact the Community

Development Department at 503-588-6173 at least three business days before this meeting or event.





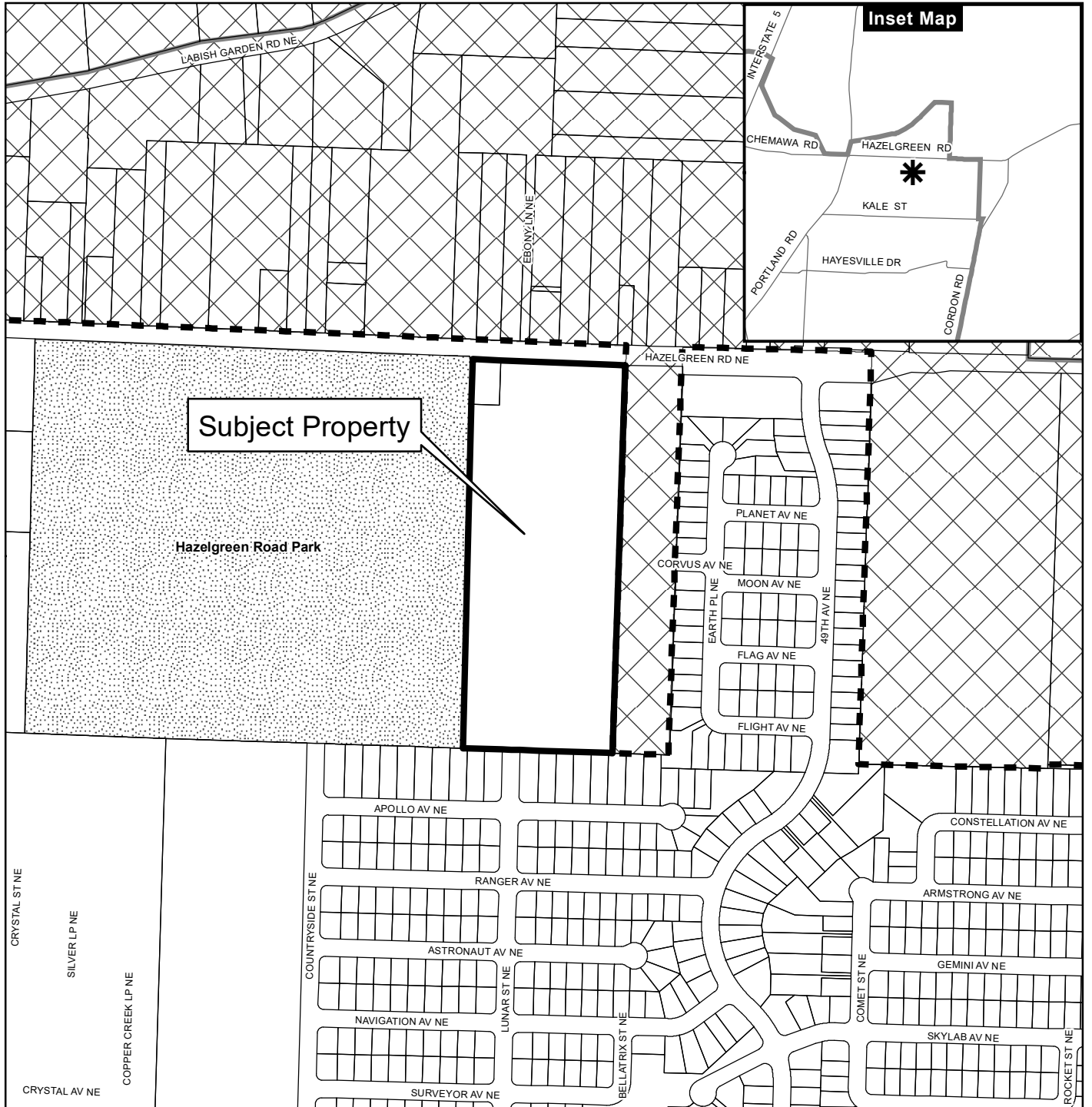

TTD/TTY telephone 503-588-6439 is also available 24/7

Vicinity Map

4650 Hazelgreen Road NE



Legend

-  Taxlots
-  Urban Growth Boundary
-  City Limits
-  Outside Salem City Limits
-  Historic District
-  Schools
-  Parks

CITY OF Salem
 AT YOUR SERVICE
 Community Development Dept.

0 100 200 400 Feet



This product is provided as is, without warranty. In no event is the City of Salem liable for damages from the use of this product. This product is subject to license and copyright limitations and further distribution or resale is prohibited.

TAX LOT 300
TAX MAP 06 2W 32C

SITE SUMMARY

TOTAL SITE AREA = 1679,449 SF (±15.60 ACRES)
PROJECT AREA = 1679,449 SF (±15.60 ACRES)
TOTAL UNITS PROVIDED = 405 UNITS
TOTAL OPEN SPACE = ±247,336 SF (±5.68 ACRES)

RM-2 ZONE DATA

RM-2 ZONE AREA = ±598,188 SF (13.73 ACRES)
IMPERVIOUS AREA = ±422,075 SF (70.56%)

DENSITY:

ALLOWED (MINIMUM) = 183 UNITS (15 UNITS/ACRE)
ALLOWED (MAXIMUM) = 379 UNITS (31 UNITS/ACRE)
PROVIDED = 360 UNITS (28.2 UNITS/ACRE)
(INCLUDES 3 UNITS OF BUILDING 12)

OPEN SPACE:

REQUIRED OPEN SPACE = ±179,456 SF (4.12 ACRES)
PROVIDED OPEN SPACE = ±234,394 SF (5.38 ACRES)

LOT COVERAGE (BUILDS AND ACCESSORY STRUCTURES):

LOT COVERAGE ALLOWED = ±330,181 SF (60%)
LOT COVERAGE PROVIDED = ±135,281 SF (25%)

SETBACKS:

ABUTTING STREET: MIN. 12 FT PLUS 1 FT FOR EACH 1 FT OF HEIGHT OVER 12 FT, BUT NEED NOT EXCEED 20 FT IN DEPTH. (SETBACK SHOWN ON PLAN = 20 FT).

INTERIOR FRONT: REFER TO ZONE TO ZONE
INTERIOR SIDE: REFER TO ZONE TO ZONE
INTERIOR REAR: REFER TO ZONE TO ZONE
VEHICLE AREA: REFER TO ZONE TO ZONE

ZONE TO ZONE SETBACKS:

RESIDENTIAL ZONE: MIN. 1 FOOT FOR EACH 1 FOOT OF BUILDING HEIGHT, BUT IN NO CASE LESS THAN 20 FT (PER SRC 702.020)

ABUTTING INDUSTRIAL ZONES:

- BUILDINGS: MIN. 15 FT
- ACCESSORY STRUCTURES: MIN. 15 FT
- VEHICLE USE AREA: MIN. 15 FT

MU-1 ZONE DATA

MU-1 ZONE AREA = ±81,267 SF (1.87 ACRES)
IMPERVIOUS AREA = ±59,557 SF (73.29%)

DENSITY:

ALLOWED (MAXIMUM) = NONE
ALLOWED (MINIMUM) = 29 UNITS (15 UNITS/ACRE)
PROVIDED = 45 UNITS (29.8 UNITS/ACRE)
(INCLUDES 9 UNITS OF BUILDING 12)

BUILDING FRONTAGE:

ABUTTING STREET: HAZELGREEN RD NE
- REQUIRED = ±188.71 FT (75%)
- PROVIDED = ±208 FT (83%)
LUNAR DR NE
- REQUIRED = ±104 FT (40%)
- PROVIDED = ±104 FT (40%)

SETBACKS:

ABUTTING STREET: MAX. 10 FT
INTERIOR SIDE: REFER TO ZONE TO ZONE
INTERIOR REAR: REFER TO ZONE TO ZONE
VEHICLE USE AREA: REFER TO ZONE TO ZONE

PARKING SUMMARY

ALLOWED MAXIMUM: 695 SPACES
(1.2/STUDIO, 1.75/OTHER UNITS)

PARKING PROVIDED:

OFF-STREET PARKING
STANDARD 547 SPACES (INCLUDES 21 ACCESSIBLE)
COMPACT 13 SPACES (INCLUDES 0 ACCESSIBLE)
TOTAL PARKING PROVIDED = 560 SPACES

LOADING ZONES

REQUIRED = 3 (200 OR MORE DWELLING UNITS)
PROVIDED = 3

REQUIRED BICYCLE PARKING = 405 SPACES (1/UNIT)

PROVIDED BICYCLE PARKING
BIKE RACK 278
1ST FLOOR = 127
TOTAL = 405 (1/UNIT)

MATCH LINE SEE SHEET P5.

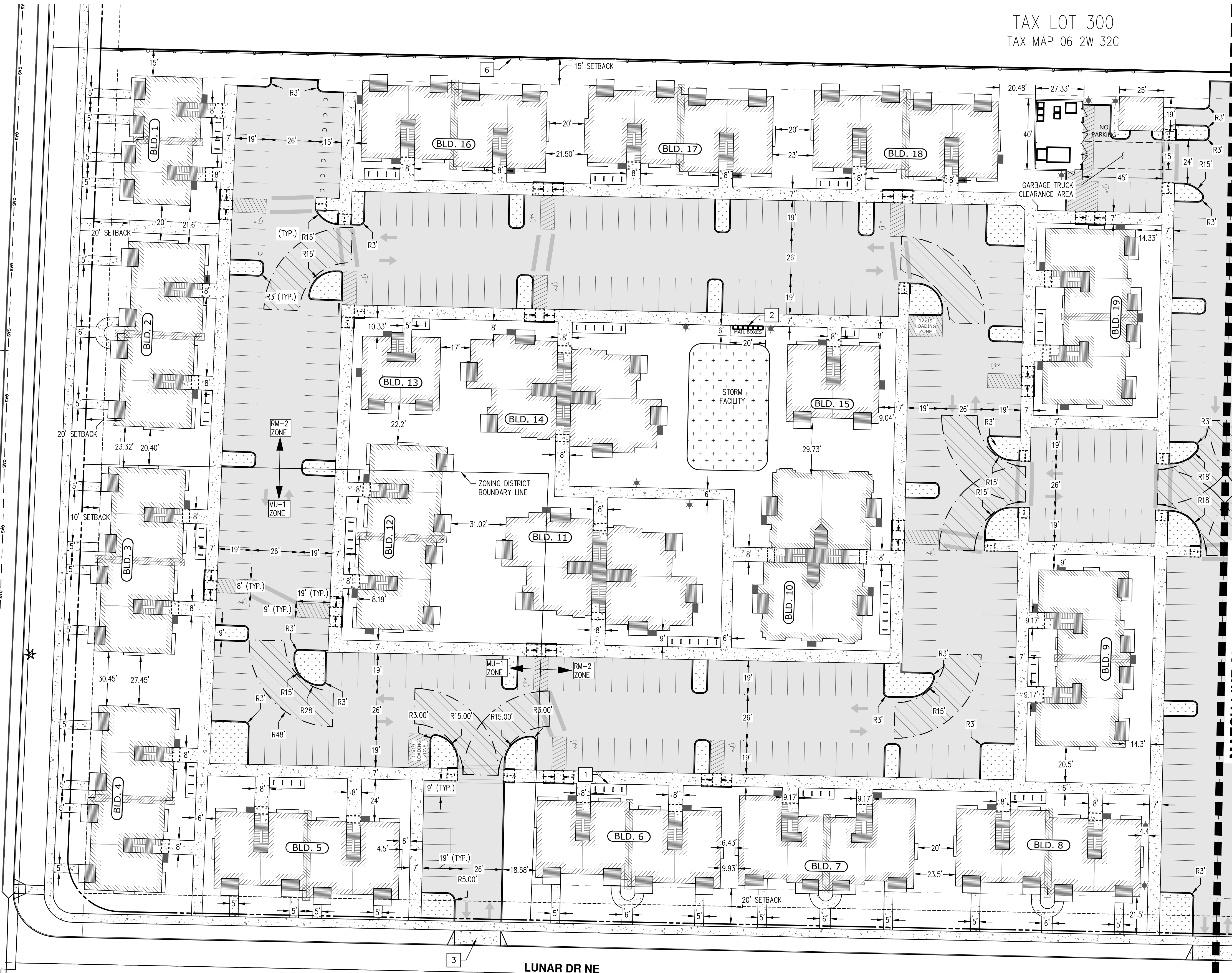

TAX LOT 100
TAX MAP 06 2W 31D

EV READY NOTE:
40% OF PARKING STALLS ARE REQUIRED TO BE EV READY PER STATE REQUIREMENTS. FINAL EV READY STALL LOCATION AND CONDUIT PLACEMENT WILL BE COORDINATED WITH PROJECT ELECTRICIAN AT TIME OF BUILDING PERMIT SUBMITTAL.

SITE KEYED NOTES:

- BIKE PARKING (2-6 STAPLES PER RACK)
- MAILBOX CLUSTER. FINAL LOCATION TO BE COORDINATED WITH USPS.
- 26' DRIVEWAY APPROACH PER CITY STANDARDS
- 24' DRIVEWAY APPROACH PER CITY STANDARDS
- 10' DRIVEWAY APPROACH PER CITY STANDARDS
- 6' SITE OBSCURING FENCE PER CITY STANDARDS AT PROPERTY LINE. FINAL FENCING SPECIFICATIONS WILL BE DETERMINED IN COORDINATION WITH ADJACENT PROPERTY OWNER
- PROPOSED TRANSIT STOP
- TRANSIT STOP ALONG WESTERN SIDE OF LUNAR DR NE FINAL LOCATION TO BE DETERMINED

LEGEND

FIRE APPARATUS MOBILITY	
STORMWATER FACILITY	
PROPOSED CONCRETE SIDEWALK (4 INCH THICKNESS)	
ASPHALT	
PROPOSED PARKING LOT LANDSCAPING	
CONCEPTUAL LIGHT POLE (FINAL LOCATION TO BE COORDINATED AT TIME OF BUILDING PERMIT)	

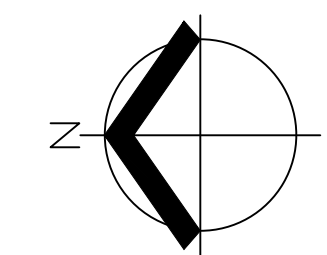

SCALE: 1" = 30 FEET
ORIGINAL PAGE SIZE: 22" x 34"

AKS
AKS ENGINEERING & FORESTRY, LLC
3700 RIVER RD. N. STE. 1
KEIZER, OR 97003
503.400.6028
WWW.AKS-ENG.COM

ENGINEERING · SURVEYING · NATURAL RESOURCES
FORESTRY · PLANNING · LANDSCAPE ARCHITECTURE

**PRELIMINARY SITE PLAN - NORTH
NORTHPLACE APARTMENTS PHASE 2
I&E CONSTRUCTION, INC.
SALEM, OREGON**

REGISTERED PROFESSIONAL ENGINEER
PRELIMINARY
NOT FOR CONSTRUCTION
D. ROTH
RENEW: DECEMBER 31, 2024

JOB NUMBER: 8321
DATE: 12/15/2023
DESIGNED BY: TDR
DRAWN BY: TBD
CHECKED BY: TDR

P5.0

**PRELIMINARY SITE PLAN - SOUTH
 NORTHPLACE APARTMENTS PHASE 2
 I&E CONSTRUCTION, INC.
 SALEM, OREGON**



RENEW: DECEMBER 31, 2024
 JOB NUMBER: 8321
 DATE: 12/15/2023
 DESIGNED BY: TDR
 DRAWN BY: TBD
 CHECKED BY: TDR

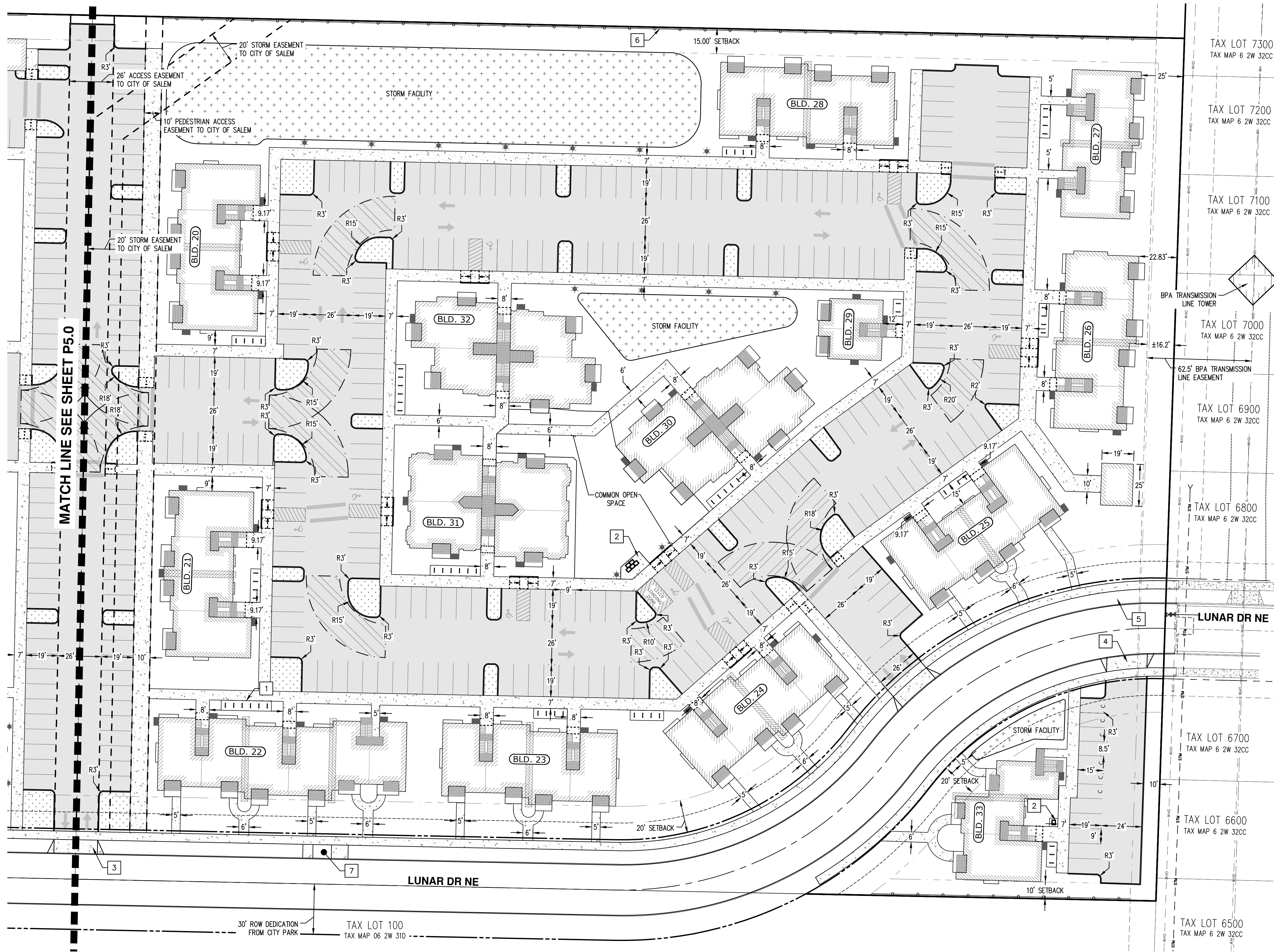

LEGEND

FIRE APPARATUS MOBILITY	
STORMWATER FACILITY	
PROPOSED CONCRETE SIDEWALK (4 INCH THICKNESS)	
ASPHALT	
PROPOSED PARKING LOT LANDSCAPING	
CONCEPTUAL LIGHT POLE (FINAL LOCATION TO BE COORDINATED AT TIME OF BUILDING PERMIT)	

- # SITE KEYED NOTES:**
- BIKE PARKING (3 STAPLES FOR 6 BIKE PARKING SPACES)
 - MAILBOX CLUSTER. FINAL LOCATION TO BE COORDINATED WITH USPS.
 - 26' DRIVEWAY APPROACH PER CITY STANDARDS
 - 24' DRIVEWAY APPROACH PER CITY STANDARDS
 - 10' DRIVEWAY APPROACH PER CITY STANDARDS
 - 6' SITE OBSCURING FENCE PER CITY STANDARDS AT PROPERTY LINE. FINAL FENCING SPECIFICATIONS WILL BE DETERMINED IN COORDINATION WITH ADJACENT PROPERTY OWNER
 - PROPOSED TRANSIT STOP
 - TRANSIT STOP ALONG WESTERN SIDE OF LUNAR DR NE FINAL LOCATION TO BE DETERMINED

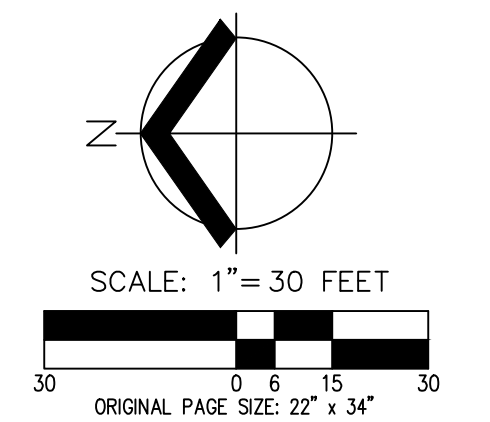

**PRELIMINARY LANDSCAPE PLAN - NORTH
 NORTHPLACE APARTMENTS PHASE 2
 I&E CONSTRUCTION, INC.
 SALEM, OREGON**



JOB NUMBER:	8321
DATE:	12/15/2023
DESIGNED BY:	JRH
DRAWN BY:	JRH
CHECKED BY:	TEB

P10.0

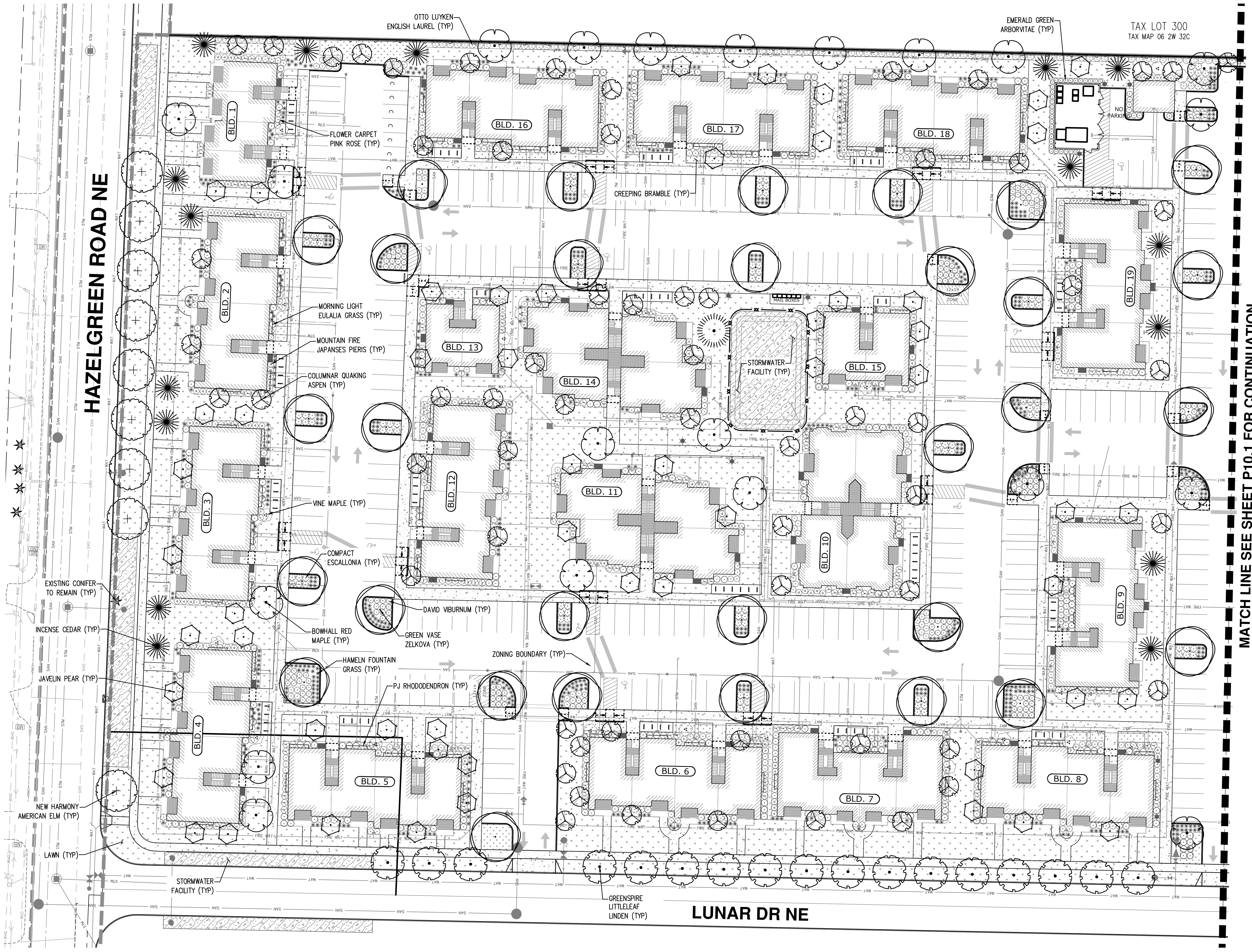

MATCH LINE SEE SHEET P10.1 FOR CONTINUATION

GENERAL NOTE

REFER TO SHEET P10.2 FOR PLANT SCHEDULE AND GENERAL LANDSCAPE NOTES.

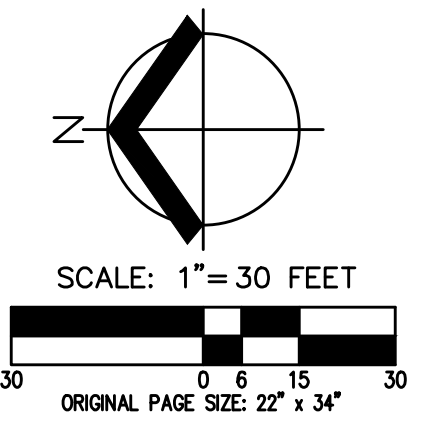

**PRELIMINARY LANDSCAPE PLAN - SOUTH
 NORTHPLACE APARTMENTS PHASE 2
 I&E CONSTRUCTION, INC.
 SALEM, OREGON**

REGISTERED
 PRELIMINARY
 NOT FOR
 CONSTRUCTION
 ARCHITECTURE

JOB NUMBER: 8321
 DATE: 12/15/2023
 DESIGNED BY: JRH
 DRAWN BY: JRH
 CHECKED BY: TEB

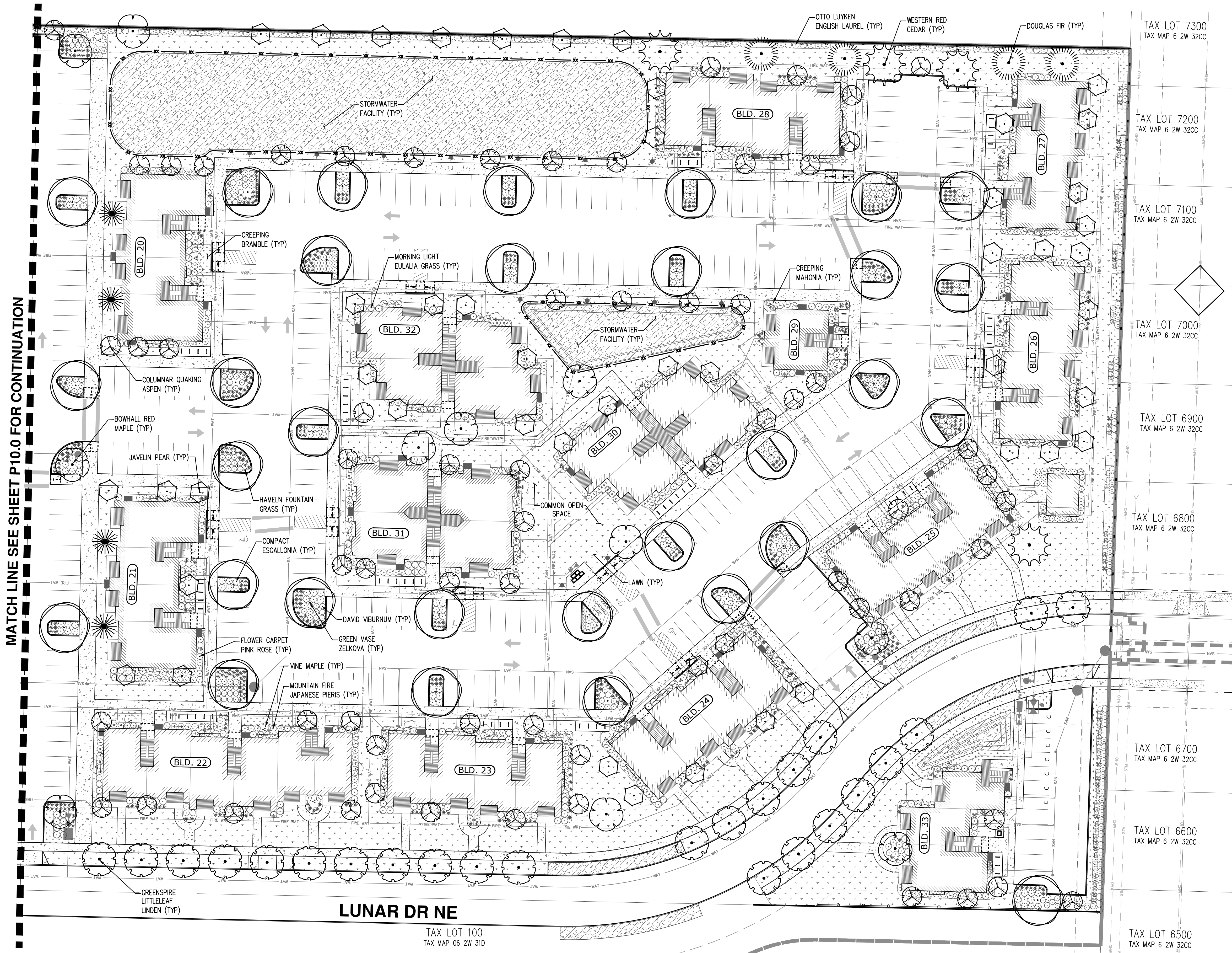

MATCH LINE SEE SHEET P10.0 FOR CONTINUATION

GENERAL NOTE

REFER TO SHEET P10.2 FOR PLANT SCHEDULE AND GENERAL LANDSCAPE NOTES.

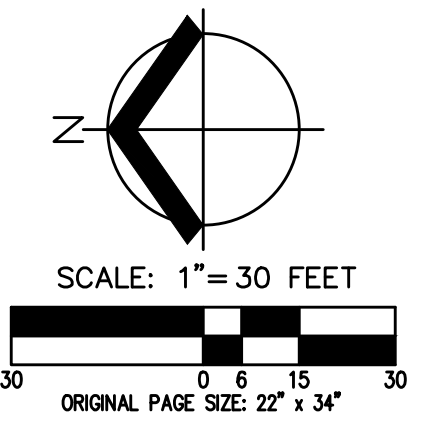

PLANT SCHEDULE - ONSITE

TREES	QTY	BOTANICAL NAME	COMMON NAME	SIZE/CONTAINER	SPACING
	32	ACER RUBRUM 'BOWHALL'	BOWHALL RED MAPLE	1.5" CAL. B&B	AS SHOWN
	20	CALOEDRUS DECURRENS	INCENSE CEDAR	6' HT. B&B	AS SHOWN
	125	POPULUS TREMULOIDES 'ERECTA'	COLUMNAR QUAKING ASPEN	1.5" CAL. B&B	AS SHOWN
	5	PSEUDOTSUGA MENZIESII	DOUGLAS FIR	6' HT. B&B	AS SHOWN
	105	PYRUS X 'NOPXI'	JAVELIN PEAR	1.5" CAL. B&B	AS SHOWN
	4	THUJA PLICATA	WESTERN RED CEDAR	6' HT. B&B	AS SHOWN
	62	ZELKOVA SERRATA 'GREEN VASE'	GREEN VASE ZELKOVA	1.5" CAL. B&B	AS SHOWN
STREET TREES	QTY	BOTANICAL NAME	COMMON NAME	SIZE/CONTAINER	SPACING
	41	TILIA CORDATA 'GREENSPIRE'	GREENSPIRE LITTLELEAF LINDEN	2" CAL. B&B	AS SHOWN
	9	ULMUS AMERICANA 'NEW HARMONY'	NEW HARMONY AMERICAN ELM	2" CAL. B&B	AS SHOWN
SHRUBS	QTY	BOTANICAL NAME	COMMON NAME	SIZE/CONTAINER	SPACING
	53	ACER CIRCINATUM	VINE MAPLE	5 GAL. CONT./30" HT. MIN.	96" o.c.
	453	ESCALLONIA X 'COMPACTA'	COMPACT ESCALLONIA	3 GAL. CONT.	48" o.c.
	79	MAHONIA REPENS	CREEPING MAHONIA	1 GAL. CONT.	36" o.c.
	551	MISCANTHUS SINENSIS 'MORNING LIGHT'	MORNING LIGHT EULALIA GRASS	3 GAL. CONT.	48" o.c.
	1,329	PENNISETUM ALOPECUROIDES 'HAMELN'	HAMELN FOUNTAIN GRASS	1 GAL. CONT.	30" o.c.
	345	PIERIS JAPONICA 'MOUNTAIN FIRE'	MOUNTAIN FIRE JAPANESE PIERIS	3 GAL. CONT.	48" o.c.
	289	PRUNUS LAUROCERASUS 'OTTO LUYKEN'	OTTO LUYKEN ENGLISH LAUREL	3 GAL. CONT.	48" o.c.
	329	RHODODENDRON X 'P.J.M.'	P.J.M. RHODODENDRON	3 GAL. CONT.	48" o.c.
	586	ROSA X 'NOATRAUM'	FLOWER CARPET PINK ROSE	1 GAL. CONT.	42" o.c.
	30	THUJA OCCIDENTALIS 'SMARAGD'	EMERALD GREEN ARBORVITAE	6' HT. CONT.	36" o.c.
	333	VIBURNUM DAVIDII	DAVID VIBURNUM	3 GAL. CONT.	42" o.c.
GROUND COVERS	QTY	BOTANICAL NAME	COMMON NAME	SIZE/CONTAINER	SPACING
	944	RUBUS CALYCNOIDES	CREEPING BRAMBLE	1 GAL. CONT.	36" o.c.
	±33,564 SF	STORMWATER FACILITY SHALL BE PLANTED TO CITY OF SALEM STANDARDS			
	±120,887 SF	LAWN: SUNMARK SEEDS NORTHWEST SUPREME LAWN SEED MIX OR APPROVED SIMILAR MIX. APPLY AT A RATE OF 8 LBS PER 1,000 SF OR AS RECOMMENDED BY SUPPLIER. MIX COMPOSITION BY WEIGHT: CUTLER II PERENNIAL RYEGRASS/LOLIMUM PERENNE (35%); DASHER III PERENNIAL RYEGRASS/LOLIMUM PERENNE (35%); GARNET CREEPING RED FESCUE/FESTUCA RUBRA (15%); WINDWARD CHEWINGS FESCUE/FESTUCA RUBRA SPP LONGIFOLIA (15%).			

GENERAL LANDSCAPE NOTES

1. PLAN REVISIONS INCLUDING CHANGES TO PLANT SPECIES, SIZES, SPACING, QUANTITIES, ETC., DUE TO PLANT AVAILABILITY OR UNFORESEEN SITE CONDITIONS MAY BE APPROVED PRIOR TO INSTALLATION WHERE ALLOWABLE BY THE CITY OF SALEM'S DESIGN STANDARDS. SUBSTITUTIONS SHALL BE OF EQUAL FORM AND FUNCTION.
2. CONTRACTOR IS RESPONSIBLE FOR VERIFYING PLANT AND MATERIAL QUANTITIES PRIOR TO BIDDING AND CONSTRUCTION AND FOR FAMILIARIZING THEMSELVES WITH SITE CONDITIONS. SHOULD DISCREPANCIES OCCUR, DESIGN INTENT PREVAILS OVER QUANTITIES LISTED.
3. ALL PLANTS AND INSTALLATION SHALL CONFORM TO THE CITY OF SALEM'S LANDSCAPE DESIGN STANDARDS AND TO THE AMERICAN STANDARDS FOR NURSERY STOCK, ANSI Z60.1, CURRENT EDITION, IN ALL WAYS. PLANT IN ACCORDANCE WITH BEST PRACTICE STANDARDS, SUCH AS THOSE ADOPTED BY THE OREGON LANDSCAPE CONTRACTOR'S BOARD (OLCB) AND THE AMERICAN HORTICULTURE INDUSTRY ASSOCIATION (AMERICAN HORT). FIELD ADJUST PLANT LOCATIONS AS NECESSARY TO AVOID CONFLICTS WITH UTILITIES, METERS, LIGHTS, TREE CANOPIES, BUILDING OVERHANGS, ETC.
4. ALL LANDSCAPING SHALL BE INSTALLED AT THE TIME OF CONSTRUCTION UNLESS OTHERWISE APPROVED BY THE CITY OF SALEM DUE TO INCLEMENT WEATHER OR TEMPORARY SITE CONDITIONS. UPON INSTALLATION, ALL PLANT MATERIALS SHALL BE VIGOROUS, WELL-BRANCHED AND WITH HEALTHY, WELL-FURNISHED ROOT SYSTEMS, FREE OF DISEASE, INSECT PESTS AND INJURIES.
5. DOUBLE STAKE ALL TREES UNLESS OTHERWISE SPECIFIED. TREES SHALL BE PLANTED NO CLOSER THAN 2' O.C. FROM SIDEWALKS, CURBING, OR OTHER HARDSCAPING; NO CLOSER THAN 6' O.C. FROM ACCESS WALKWAYS, FIRE HYDRANTS, ROOF DRAINS CATCH BASINS, MANHOLES, WATER METERS, GAS AND ELECTRIC SERVICES, UTILITY BOXES AND VAULTS, AND MOUNTED PEDESTALS; NO CLOSER THAN 10' O.C. FROM ALLEYS, DRIVEWAYS, TRAFFIC SIGNALS, STREET LIGHT STANDARDS AND UTILITY LINES. TREES IN PLANTING ISLANDS SHALL BE CENTERED IN ISLAND. REFER ALSO TO THE CITY OF SALEM STANDARD TREE-SHRUB PLANTING DETAIL NO. 803 (SHEET L1.1)
6. PLANTING AND INSTALLATION OF ALL REQUIRED LANDSCAPING SHALL BE INSPECTED AND APPROVED PRIOR TO THE ISSUANCE OF A CERTIFICATE OF OCCUPANCY UNLESS OTHERWISE APPROVED BY THE CITY OF SALEM.
7. SOIL PREPARATION: ALL SHRUB BEDS SHALL HAVE A MINIMUM OF 12" OF CLEAN TOPSOIL. EXISTING NATIVE SOIL OR STOCKPILED TOPSOIL STRIPPINGS MAY BE USED. TOPSOIL SHALL BE RICH DARK BROWN IN COLOR AND VOID OF ROOTS, PLANTS, WEEDS, SEEDS, SOD, STONES, CLAY LUMPS, ALKALI SALTS, DEBRIS, AND OTHER EXTRANEOUS MATERIALS HARMFUL TO PLANT GROWTH. IF IMPORTED TOPSOIL IS REQUIRED CONTRACTOR SHALL LOOSEN SUBSOIL TO A MINIMUM DEPTH OF 18" AND REMOVE ANY DEBRIS OR MATERIAL THAT MAY INHIBIT HEALTHY PLANT GROWTH PRIOR TO INSTALLATION OF TOPSOIL. IF NATIVE SOIL TO BE USED BECOMES COMPACTED DURING CONSTRUCTION ACTIVITY, CONTRACTOR SHALL LOOSEN TO A MINIMUM OF 12" AND AMEND EXISTING TOPSOIL WITH 2" OF VEGETATIVE COMPOST (SUCH AS COMPOSTED YARD WASTE) TILLED INTO THE SOIL. TOPSOIL SHALL BE PLACED OR WORKED IN FRIABLE (WORKABLE) CONDITION. SOIL SHALL NOT BE WORKED WHEN SATURATED TO PREVENT OVER-COMPACTION. FINISH GRADE OF ALL NEW PLANTINGS SHALL SEAMLESSLY MEET FINISH GRADE OF ANY EXISTING LANDSCAPE AREAS TO REMAIN AND AS INDICATED ON GRADING PLANS. PLANTING BED AREAS SHALL PROVIDE POSITIVE DRAINAGE AS INDICATED ON THE GRADING PLANS AND BE FREE OF HOLES, DIVOTS, OR HIGH/LOW SPOTS WHICH MAY CAUSE WATER TO COLLECT. BACKFILL PLANTING HOLES WITH A MIXTURE OF 1/3 ORGANIC MATERIAL, 1/3 TOPSOIL, AND 1/3 SANDY LOAM. SOIL FOR STREET TREES SHALL BE PREPARED AND AMENDED TO A WIDTH OF AT LEAST 3 TIMES THE SIZE OF THE ROOT BALL.
8. A PERMANENT UNDERGROUND IRRIGATION SYSTEM WITH A BACKFLOW DEVICE APPROVED BY THE CITY OF SALEM, SHALL BE PROVIDED FOR ALL LANDSCAPED AREAS WITHIN THE PROJECT WORK AREA FOR THE ESTABLISHMENT AND LONG-TERM HEALTH OF PLANT MATERIAL. THE IRRIGATION SYSTEM SHALL BE 'DESIGN-BUILD' BY THE LANDSCAPE CONTRACTOR, USING CURRENT WATER-SAVING TECHNOLOGY, AND INCLUDE ALL MATERIALS, COMPONENTS, CITY APPROVED BACKFLOW OR ANTI-SIPHON DEVICES, VALVES, ETC. NECESSARY FOR THE COMPLETE AND EFFICIENT COVERAGE OF LANDSCAPE AREAS SHOWN. THE LANDSCAPE CONTRACTOR SHALL COORDINATE WITH THE GENERAL CONTRACTOR AND OWNER FOR IRRIGATION POINT-OF-CONNECTION (P.O.C.), SLEEVING LOCATION, CONTROLLER, POWER SOURCE, AND MAINLINE LAYOUT PRIOR TO ANY PAVING REPAIR OR STRIPING. CONTRACTOR SHALL PROVIDE THE CITY OF SALEM WITH AN IRRIGATION PLAN INCLUDING ZONING AND COMPONENT LAYOUT FOR APPROVAL PRIOR TO INSTALLATION AS A DELAYED SUBMITTAL.
9. THE OWNER SHALL BE RESPONSIBLE FOR MAINTAINING ALL LANDSCAPE MATERIAL IN GOOD CONDITION SO AS TO PRESENT A HEALTHY, NEAT AND ORDERLY APPEARANCE IN KEEPING WITH CURRENT INDUSTRY STANDARDS. UNHEALTHY OR DEAD PLANT MATERIALS SHALL BE REPLACED IN CONFORMANCE TO THE REQUIREMENTS OF THE ORIGINALLY APPROVED LANDSCAPE PLAN.
10. MULCH: APPLY 3" DEEP WELL-AGED DARK HEMLOCK OR FIR, MEDIUM GRIND, UNDER AND AROUND ALL PLANTS IN PLANTING BEDS. DO NOT COVER FOLIAGE OR ROOT CROWNS OF PLANT MATERIAL WITH MULCH. MULCH SHALL BE AT LEAST 12" AWAY FROM ROOT FLARE OF TREE, THE FLARE SHALL REMAIN VISIBLE AND EXPOSED TO AT LEAST FINISH GRADE.
11. GROUNDCOVER SHALL NOT BE PLANTED CLOSER THAN 24" FROM CATCH BASINS OR DRAIN AREAS. SHRUBS SHALL NOT BE PLANTED CLOSER THAN 36" FROM CATCH BASINS AND BUILDING FOUNDATIONS. NO LANDSCAPE PLANT/GROUNDCOVER SHALL BE PLACED WITHIN 3' OF ANY NEW TREE.

RM-2 ZONE LANDSCAPE DATA

RM-2 ZONE AREA: ±598,188 SF
 360 UNITS (INCLUDES 3 UNITS OF BUILDING 12)

COMMON OPEN SPACE REQUIRED: 5,550 SF (1,000 SF PLUS AN ADDITIONAL 250 SF FOR EVERY 20, OR PORTION THEREOF, OVER 20 UNITS)
 COMMON OPEN SPACE PROVIDED: 5,601 SF
 MINIMUM DIMENSIONS REQUIRED: 20' ALL SIDES AND 500 SF;
 MINIMUM DIMENSIONS PROVIDED: EXCEEDS

MINIMUM SITE TREES PER 702.020(b)(2)(a) REQUIRED (1 PER 2,000 SF GROSS SITE AREA): 299 TREES
 TOTAL PROPOSED SITE TREES: 332 (EXCLUDES STREET TREES)

2 SHRUB P.U. AT EACH PRIMARY BUILDING ENTRANCE REQUIRED: 70 P.U.
 SHRUB P.U. PROPOSED: 70 P.U.

10 TREE P.U. PER 60 LF OF BUILDING EXTERIOR, WITHIN 25 FT OF BUILDING (13,520 LF / 60 LF X 10): 2,253 TREE P.U. REQUIRED
 TREE P.U. PROPOSED: 2,260 P.U.

1 SHRUB P.U. PER 15 LF OF BUILDING EXTERIOR (13,520 LF / 15 LF): 901 SHRUB P.U.
 SHRUB P.U. PROPOSED: 6,559 P.U.

PARKING LOT LANDSCAPING
 PARKING PERIMETER (7,729 LF) TREES REQUIRED 1 PER 50 LF: 148
 PARKING PERIMETER TREES PROVIDED: 236
 PARKING BAY TREES REQUIRED (1 PER BAY): 64
 PARKING BAY TREES PROVIDED: 65

MU-1 ZONE LANDSCAPE DATA

MU-1 ZONE AREA: ±81,267 SF

PARKING LOT LANDSCAPING
 PARKING LOT IMPERVIOUS AREA: 20,141 SF
 INTERIOR PARKING LOT LANDSCAPING REQUIRED (MIN 8%): 1,611 SF
 INTERIOR PARKING LOT LANDSCAPING PROVIDED: 1,962 SF (10%)

PARKING LOT TREES REQUIRED (MIN 1 TREE PER 12 PARKING SPACES): 5 TREES
 PARKING LOT TREES PROVIDED: 7 TREES

PRELIMINARY LANDSCAPE SCHEDULE AND NOTES
NORTHPLACE APARTMENTS PHASE 2
I&E CONSTRUCTION, INC.
SALEM, OREGON

AKS
 AKS ENGINEERING & FORESTRY, LLC
 3700 RIVER RD N, STE 1
 KEIZER, OR 97003
 503.400.6028
 WWW.AKS-ENG.COM
 ENGINEERING • SURVEYING • NATURAL RESOURCES
 FORESTRY • PLANNING • LANDSCAPE ARCHITECTURE



JOB NUMBER:	8321
DATE:	12/15/2023
DESIGNED BY:	JRH
DRAWN BY:	JRH
CHECKED BY:	TEB



LAND USE APPEAL APPLICATION

1. **GENERAL DATA REQUIRED** *[to be completed by the appellant]*

UGA-SPR-ADJ-DAP-DR-PLA24-03 February 29, 2024
 Case # Being Appealed Decision Date

4650 Hazelgreen Rd NE, Salem, OR 97305
 Address of Subject Property

4795 Apollo Ave NE, Salem, OR 97305
 Appellants Mailing Address with zip code

sdschulke@gmail.com (503) 580-8597
 Appellant's E-mail Address Day-time Phone / Cell Phone

Appellant's Representative or Professional to be contacted regarding matters on this application, if other than appellant listed above:

Yasha Renner, AAL 429 N. Water St. Ste B, Silverton, OR 97381
 Name Mailing Address with ZIP Code

yasha@rennerlawfirm.com (503) 770-4040
 E-Mail Address Day-time Phone / Cell Phone

2. **SIGNATURES OF ALL APPELLANTS**

Signature:  Date: 3/13/24

Printed Name: Steven Schulke

Signature: _____ Date: _____

Printed Name: _____

3. **REASON FOR APPEAL** Attach a letter, briefly summarizing the reason for the Appeal. Describe how the proposal does not meet the applicable criteria as well as verification establishing the appellants standing to appeal the decision as provided under SRC 300.1010

FOR STAFF USE ONLY		
Received By: <u>Aaron Panko</u>	Date: <u>3-14-2024</u>	Receipt No: <u>24-106369-GP</u>
Appeal Deadline: <u>3-15-2024, 5:00 PM</u>	Case Manager: <u>Aaron Panko</u>	



RENNERLAWFIRM,P.C.

429 N. Water St.
Suite B
Silverton, OR 97381

Ph: (503) 770-4040
Fx: (503) 300-1784

Mr. Yasha Renner
ATTORNEY AT LAW

YASHA@RENNERLAWFIRM.COM

March 14, 2024

BY FIRST CLASS MAIL AND EMAIL

Planning Division
555 Liberty Street SE
Salem, OR 97301
Email: planning@cityofsalem.net

Re: NOTICE OF REPRESENTATION AND APPEAL (SRC 300.1010 et seq.)
Case No: UGA-SPR-ADJ-DAP-DR-PLA24-03
Subject Property: Tax Lot 400 (Tax Map 06 2W 32C)

To: Hearings Officer

Please be advised that this law firm represents Steven Shulke (“Appellant”), an aggrieved party with standing to appeal the following land-use decisions in the above-referenced case. This letter specifies my client’s reasons for appeal pursuant to Salem Revised Code (SRC) 300.1020.

I. DECISION(S) APPEALED

The following decision of the Planning Administrator is appealed:

Class 2 Adjustment to adjust the fencing and tree planting requirements of SRC 702.020(b)(2) along the southern boundary where the subject property abuts a BPA (Bonneville Power Administration) easement.

II. STANDING

Appellant is the owner of record of the real property located at 4795 Apollo Ave NE, Salem, OR 97305, which is zoned RS (single family residential) and abuts the proposed development of the subject property located at 4650 Hazelgreen Road NE, Salem, OR 97305 (the “Subject Property”). Appellant submitted comments during the public comment period and received a notice of decision dated February 29, 2024. Accordingly, Appellant has standing to appeal under SRC 300.520(f)(2).

III. REASONS FOR APPEAL

(A) Applicable Criteria for Granting a Class 2 Adjustment.

The foregoing decision on appeal was requested and granted as a Class 2 adjustment, which is defined as “an adjustment to any development standard in the UDC other than a Class 1 adjustment, including an adjustment to any numerical development standard in the UDC that increases or decreases the standard by more than 20 percent.” SRC 250.005(a)(1)(B).

March 14, 2024

Page 2 of 5

Case No: UGA-SPR-ADJ-DAP-DR-PLA24-03

The criteria for granting a Class 2 adjustment are set forth in SRC 250.005(d)(2), which requires the proposed adjustment to satisfy all of the following elements:

- (A) The purpose underlying the specific development standard proposed for adjustment is:
 - (i) Clearly inapplicable to the proposed development; or
 - (ii) *Equally or better met by the proposed development.*
- (B) If located within a residential zone, the proposed development will not detract from the livability or appearance of the residential area.
- (C) If more than one adjustment has been requested, the cumulative effect of all the adjustments result in a project which is still consistent with the overall purpose of the zone.

SRC 250.005(d)(2) (emphasis added).

(B) Analysis of Land-Use Decision on Appeal

SRC 702.020(b)(2) provides, in pertinent part:

Where a development site abuts property that is zoned . . . Single Family Residential (RS), *a combination of landscaping and screening* shall be provided to *buffer* between the multiple family development and the abutting . . . RS zoned property. The landscaping and screening shall include the following:

- (A) A minimum of one tree, not less than 1.5 inches in caliper, for every 30 linear feet of abutting property width; and
- (B) a minimum six-foot tall, decorative, sight-obscuring fence or wall. The fence or wall shall be constructed of materials commonly used in the construction of fences and walls, such as wood, stone, rock, brick, or other durable materials. Chainlink fencing with slats shall be not allowed to satisfy this standard.

SRC 702.020(b)(2).

For purposes of applying this standard, the term *abutting* means “touching along a boundary or point.” SRC 111.001.

As a preliminary matter, it must be noted that the specific design review standard at issue contemplates the installation of landscaping and screening *on the Subject Property* that is owned by the applicant, not on the abutting property owned by Appellant. Logically, because a tree cannot be planted along the same line where a fence or wall is installed, one must be situated behind the other. Thus, for example, trees may be planted either behind or in front of the required screening, but SRC 702.020(b)(2) is silent regarding the distance between these design features. In any case, it goes without saying that the term *abutting* is not to be strictly construed for purposes of this design standard, but rather embraces some degree of reasonable discretion in planning the physical location of these design elements upon the Subject Property.

March 14, 2024

Page 3 of 5

Case No: UGA-SPR-ADJ-DAP-DR-PLA24-03

Moreover, SRC 702.020(b)(2) requires a “combination” of both (1) landscaping with living trees and (2) screening with a sight-obscuring fence or wall. These are separate and complementary requirements under SRC 702.020(b)(2), which specifies intrinsically different materials: a natural landscaping feature, on the one hand, together with a man-made structure on the other. The structural design feature must also be “decorative” according to the design review standard. Accordingly, any proposed adjustment that does not include *both* design elements—that is, natural landscaping and non-natural decorative screening—cannot fulfill the underlying purposes of the standard because it is not “equally or better met” by the proposed development.

As stated in SRC 702.020(b)(2), that underlying purpose is to provide a “buffer” between the multiple family development and the abutting RS zoned property. Further, the underlying purpose of all landscaping and screening standards applicable under the Unified Development Code (UDC) is to “improve the appearance and visual character of the community, promote compatibility between land uses . . . and preserve and enhance the livability of the City.” SRC 807.001 (stating purpose of landscaping and screening standards under SRC chapter 807).

Nonetheless, the Planning Administrator granted the proposed adjustment for the following reasons stated in the notice of decision (pages 34–35, emphasis added):

The applicant indicates that the reason for the request to reduce the tree planting and fencing is because of the existing 125-foot-wide easement for a BPA (Bonneville Power administration) transmission line. The easement extends across the entire southern boundary of the property with a width of approximately 16 feet on the subject property and 109 feet on the abutting RS (Single Family Residential) zoned properties to the south. No buildings or structures can occur within the easement, including fencing. ***Trees and vegetation exceeding a height of five feet are also not permitted in the easement area; therefore, it is not possible to provide the required buffering along the southern property line in the easement area.*** The applicant proposes to landscape the southern boundary with dense shrubs that will provide a physical and visual barrier and will be maintained in compliance with the requirements of the BPA easement. The proposal equally or better meets the intent of this provision and is therefore in compliance with this criterion.

As noted, the BPA power-line easement constitutes a nonpossessory interest in private lands. As such, it is a private easement and restriction on the use of land. But the UDC expressly provides that it “shall be applied independently of, *and without regard to*, any private easement, covenant, condition, restriction, or other legally enforceable interest in, or obligation imposed on, the use or development of land.” SRC 110.060(a) (emphasis added). “In those instances where the UDC imposes a greater restriction or higher standards than required by an easement, covenant, condition, restriction, or other agreement between private parties, *or where the UDC otherwise conflicts with those private party agreements, the UDC shall control.*” SRC 110.060(b) (emphasis added).

Therefore, the land-use restrictions and rights incident to the BPA power-line easement are immaterial for purposes of the application of SRC 702.020(b)(2). The Planning Administrator erred by considering and granting an adjustment on this basis, and the decision constitutes a modification of the *applicability* of a requirement that is expressly prohibited by SRC 250.005(a)(2)(E).

March 14, 2024

Page 4 of 5

Case No: UGA-SPR-ADJ-DAP-DR-PLA24-03

Further, with respect to the purported building restrictions due to BPA's easement, it should be noted that the applicant proposes to build a 6-foot perimeter fence along the eastern boundary of the Subject Property in compliance with the requirements of SRC 702.020(b)(2). As shown on the preliminary site plan (P5.1), the fence will, in fact, extend into the BPA easement area a distance of approximately 16 feet. This undermines the applicant's purported rationale for seeking an adjustment in the first place. Even if it is true that the terms of the easement prohibit construction of a fence or wall within the easement area, then the adjustment that should have been requested (and granted) is to relocate both the fence and trees, by moving both design features backward a distance of about 16 feet from the abutting property line in order to clear the easement area.

Notwithstanding SRC 110.060, which is dispositive, the proposed development, as adjusted, does not satisfy the criteria set forth in SRC 250.005(d). The applicant "proposes to landscape the southern boundary with dense shrubs that will provide a physical and visual barrier." *Notice of Decision* 34–35. The species of shrubs are identified on the applicant's plant schedule as *Mahonia Repens* (Creeping Mahonia) and *Prunus Laurocerasus* (Otto Luyken English Laurel), with *Rubus Calycinoides* (Creeping Bramble) as ground cover.

A dwarf form of the larger English Laurel, Otto Luyken English (or Cherry) Laurel is an evergreen shrub that typically grows 3 feet tall and spreads 6 to 8 feet. The plant's fruit, leaves, and stems are poisonous to humans. As shown on the preliminary site plan (P10.1), this species will be planted along the southernmost boundary for the Subject Property. Just behind these, the applicant intends to plant Creeping Mahonia (also known as Creeping Oregon Grape), which is an extremely short, sprawling shrub that commonly grows no more than 8 to 12 inches and occasionally up to 2 feet. Suffice it to say, these two plant species, even when fully mature, cannot and will not provide an equal measure of privacy, nor visual character, nor buffer between the Subject Property and Appellant's property than trees (one tree for every 30 linear feet of abutting property width) and the 6-foot decorative fence or wall that is required by SRC 702.020(b)(2). Therefore, the proposed development does not *equally* meet the underlying purposes of this specific development standard.

As explained above, the underlying purpose of SRC 702.020(b)(2) is not merely to create a physical and visual obstruction, however dense, between the proposed multi-family development and RS zoned properties. Rather, the development standard uses the term *buffer*, which has a much wider connotation than the word *obstruction*, and embraces not only the privacy of the abutting RS-zoned property owners—specifically by means of a 6-foot tall decorative fence or wall. Additionally, the term *buffer* includes a protective element due to the incompatibility of land uses and the "nuisances" that will result from having a large multi-family apartment complex 125 feet from Appellant's back yard. A sight-obscuring fence or wall is designed to contain and buffer these nuisance activities, such as vehicle headlights from the nearby parking lot, trash and litter carried by wind, or even potential foot traffic. By contrast, a hedge of low- (and slow-)growing shrubs is not sufficient to provide an equally effective barrier. The hedgerow will take time to grow and spread, several years perhaps, but in the mean time there will be 4-foot gaps between each laurel.

Finally, as discussed above, SRC 702.020(b)(2) requires a combination of natural and non-natural design elements, the purpose of which is to "improve the appearance and visual character of the community, promote compatibility between land uses . . . and preserve and enhance the livability

March 14, 2024

Page 5 of 5

Case No: UGA-SPR-ADJ-DAP-DR-PLA24-03

of the City.” SRC 807.001. Absent a decorative wall or fencing, a hedgerow cannot equally meet any of these purposes. Indeed, as landscaping design features, the tree and screening requirements under SRC 702.020(b)(2) are therefore intended to preserve the livability of the City, as well as to *enhance* that livability. At a minimum, these underlying purposes must be equally met by the proposed development. Appellant has grown up and worked in the City of Salem for most of his life. For him, the livability of the City will undoubtedly be adversely impacted by the lack of adequate screening between the proposed development and his home.

For the foregoing reasons, this appeal is respectfully submitted for a final decision.

Sincerely,

A handwritten signature in blue ink that reads "Yasha Renner". The signature is fluid and cursive, with a long horizontal stroke at the end.

Yasha Renner