



Efficient Public Lighting Options

Winter 2010 • Product Design

Liesel Sylwester • Material and Product Studies

Jason O. Germany • Assistant Professor • Product Design



Sustainable Cities Initiative

Acknowledgements

The authors wish to acknowledge and thank the following people for their assistance with this project. It would not have been possible without them.

City of Salem

Peter Fernandez, Public Works Director

Mark Bechtel, Parks and Transportation Services Manager, Public Works

Kevin Hottman, City Traffic Engineer, Public Works

Eric Schrunck, Traffic Signal Maintenance Supervisor, Public Works

Courtney Knox, Project Manager, Urban Development Department

Salem Electric

Tony Schacher, Engineer

Terry Kelly, Member Services Manager

Portland General Electric

Mark Whitney, Lighting Specialist

Tracy Aguilar, Lighting Specialist

Salem-Keizer Transit

Allan Pollock, General Manager / CEO

BCG Tech

Nathan Wiedenmann, Vice President

Michael McCormick, Sales Representative

Light Beam Industries

John Darland, Owner

Nick Liebrecht, Sr. Engineer

Bert Schumann, Sr. Engineer

Baker Lighting Lab, School of Architecture and Allied Arts, University of Oregon

Jill Mulholland, PhD, University of Oregon Baker Visiting Professor

InSpec Energy Solutions

Cory Murman, Project Manager

About SCI

The Sustainable Cities Initiative (SCI) is a cross-disciplinary organization at the University of Oregon that seeks to promote education, service, public outreach, and research on the design and development of sustainable cities. We are redefining higher education for the public good and catalyzing community change toward sustainability. Our work addresses sustainability at multiple scales and emerges from the conviction that creating the sustainable city cannot happen within any single discipline. SCI is grounded in cross-disciplinary engagement as the key strategy for solving community sustainability issues. We serve as a catalyst for expanded research and teaching, and market this expertise to scholars, policymakers, community leaders, and project partners. Our work connects student energy, faculty experience, and community needs to produce innovative, tangible solutions for the creation of a sustainable society.

About SCY

The Sustainable City Year (SCY) program is a year-long partnership between SCI and one city in Oregon, in which students and faculty in courses from across the university collaborate with the partner city on sustainability and livability projects. SCY faculty and students work in collaboration with staff from the partner city through a variety of studio projects and service-learning courses to provide students with real-world projects to investigate. Students bring energy, enthusiasm, and innovative approaches to difficult, persistent problems. SCY's primary value derives from collaborations resulting in on-the-ground impact and forward movement for a community ready to transition to a more sustainable and livable future. SCY 2010-11 includes courses in Architecture; Arts and Administration; Business Management; Interior Architecture; Journalism; Landscape Architecture; Law; Planning, Public Policy, and Management; Product Design; and Civil Engineering (at Portland State University).

About Salem, Oregon

Salem, the capital city of Oregon and its third largest city (population 157,000, with 383,000 residents in the metropolitan area), lies in the center of the lush Willamette River valley, 47 miles from Portland. Salem is located an hour from the Cascade mountains to the east and ocean beaches to the west. Thriving businesses abound in Salem and benefit from economic diversity. The downtown has been recognized as one of the region's most vital retail centers for a community of its size. Salem has retained its vital core and continues to be supported by strong and vibrant historic neighborhoods, the campus-like Capitol Mall, Salem Regional Hospital, and Willamette University. Salem offers a wide array of restaurants, hotels, and tourist attractions, ranging from historic sites and museums to events that appeal to a wide variety of interests. 1,869 acres of park land invite residents and visitors alike to enjoy the outdoors.

Course Participants

Group 1, Streetlights: Solar Hybrid Streetlighting

Sierra Kuntz, Material and Product Studies Undergraduate
Phill Murff, Material and Product Studies Undergraduate
Alyssa Wasson, Material and Product Studies Undergraduate

Group 2, Streetlights: The ViperHead

Zoe Blatter, Material and Product Studies Undergraduate
Jordan Giboney, Material and Product Studies Undergraduate
Liesel Sylwester, Material and Product Studies Undergraduate

Group 5, Streetlights: The M.E. Light

Nathan Eshleman, Material and Product Studies Undergraduate
Sarah Morgan, Material and Product Studies Undergraduate
Kristopher Schaefer, Material and Product Studies Undergraduate

Group 3, Parks: The MELAS

Charlie Hartzell, Material and Product Studies Undergraduate
Ian Kenny, Material and Product Studies Undergraduate
Damien Menard, Material and Product Studies Undergraduate

Group 4, Parks: Wayfinding

Risa Beck, Architecture Undergraduate, Material and Product Studies Undergraduate
Patrick McAffrey, Architecture Undergraduate, Material and Product Studies Undergraduate
Danielle Thireault, Architecture Undergraduate, Material and Product Studies Undergraduate

Group 6, Public Transit: Solar-powered Bus Stops

Tara Nielsen, Material and Product Studies Undergraduate
Tori Russo, Material and Product Studies Undergraduate
Kara Williams, Material and Product Studies Undergraduate

SCI Directors and Staff

Robert Liberty, Executive Director

Nico Larco, SCI Associate Director, and Assistant Professor of Architecture

Marc Schlossberg, SCI Associate Director, and Associate Professor of Planning, Public Policy, and Management

Chris Jones, SCI Program Manager

Amy Hause, SCI Program Manager

Table of Contents

Acknowledgements	2
Executive Summary	6
Introduction	7
Research	10
Concepts: Streetlighting	22
Concepts: Parks and Public Spaces	30
Concepts: Public Transit	34
Conclusions	36
Appendix	38
References	45

This report represents original student work and recommendations prepared by students in the University of Oregon’s Sustainable City Year program for the City of Salem, the Urban Renewal Agency of the City of Salem, or the Salem Housing Authority. Text and images contained in this report may not be used without permission from the University of Oregon.

Executive Summary

Salem's current streetlighting consists of high-pressure sodium (HPS) lights in standard cobra head fixtures. The City of Salem has found that these lights no longer meet their needs, especially in terms of the level and quality of light they provide, and in terms of cost and how much energy they consume. In conjunction with the Sustainable Cities Initiative, Salem is pursuing more energy-efficient and sustainable streetlighting options. In addition, Salem was interested in determining the level of illumination that would best serve its residents. Salem was also particularly interested in new lighting technologies, like LEDs and induction lighting, and in how they might be implemented in the city.

A Product Design studio course from the University of Oregon took on the Efficient Public Lighting Options project and worked to develop design concepts that would meet Salem's lighting needs and reduce their energy use. The ten-week project focused on analyzing Salem's current streetlighting and identifying areas for improvement, and on generating lighting solutions that would address areas that are lacking in the current lighting.

Eighteen students in the course worked in groups of three to focus on specific types of public lighting. Much of the project consisted of research, beginning with analyzing case studies of other cities that have already implemented sustainable public lighting solutions. Students also conducted surveys to determine what flaws the residents found in their streetlighting, and measured the photometric footprints of existing streetlights to determine how effective the spread of light was and how it might be made more effective.

The design groups then worked on generating ideas, based on their research, that would address the many issues they had identified. Students also analyzed existing lighting technologies to determine which was the most energy-efficient and which would be the most suitable for Salem. The design groups developed and refined their concepts for new lighting systems over the course of the project, and worked with the City of Salem throughout. The students also consulted with a number of local lighting experts and staff from Salem Electric, Portland General Electric, and Salem-Keizer Transit. At the end of the project, each group presented their final design concept and the associated research to the City of Salem for their consideration. The details of the Efficient Public Lighting Options project and of the final design concepts presented by the Product Design studio are presented in this report.

Main themes of the project included:

- Reduced energy consumption
- Reduced costs
- Reduced maintenance
- New lighting technologies
- Ease of maintenance
- Off-grid options
- Application of light, reduced light pollution

Introduction

Project Overview

The Efficient Public Lighting Options project was a collaboration between a University of Oregon Product Design studio course and a Planning, Public Policy and Management Capstone project to develop energy efficient and sustainable streetlight designs for the City of Salem, and to find more sustainable funding to support those lights. The Product Design segment of the project is discussed here.

Existing Conditions and Objectives

The primary goal of the Product Design segment of the project was to examine public lighting and the implementation of new lighting technologies that might be applied in Salem. The City of Salem currently has about 8,600 streetlights, which result in \$1.2 million in electricity costs per year, in addition to maintenance costs. The streetlights are owned and maintained by the City of Salem, Portland General Electric (PGE), and Salem Electric. The specifics of the ownership and maintenance agreements can be found in the Capstone project report.

Salem's public lighting, like most public lighting across the country, predominantly consists of high-pressure sodium (HPS) bulbs. The city expressed interest in emerging lighting technologies, like LEDs and induction lighting, for their energy-saving benefits, but was concerned about the cost of implementing them. The Product Design studio's task was to analyze the potential applications and opportunities of emerging lighting technologies and to make recommendations based on their conclusions. Salem was also interested in research and case studies on cities that have already successfully implemented energy efficient lighting systems, and how those systems might be implemented in Salem.

Another of Salem's concerns was that their current standards for illumination, which were last updated in 1986 based on then-current recommendations of the Illuminating Engineering Society, may call for streetlights to provide an excessive amount of light. The city's staff feel that the streetlights, many of which do not comply with the standard, are bright enough as they are. Salem hoped that the Product Design studio would be able to assess the brightness of their current lighting, either qualitatively or quantitatively, and make recommendations accordingly.

At the end of the project, Salem hoped to come away with an analysis of their current lighting and design concepts for energy efficient public lights. While they may or may not choose to implement any of the concepts explicitly, the hope was that the ideas presented would spark discussions and that Salem would be able to use the design concepts as a starting point to be refined into an improved public lighting solution for the city.

Site Analysis

Salem has a variety of distinct areas with different lighting needs, including residential and business districts. There are presently upwards of 50 different types of streetlights in use in Salem. The city highlighted three areas with specific lighting needs for the Product Design studio to address in the project:

- 13th Street NE, C Street NE, 17th Street NE, and Court Street NE: an established residential neighborhood with mature trees lining the streets. The trees are beginning to block and conflict with the streetlighting.
- State Street and Court Street: these streets run through downtown Salem and end at Riverfront Park. This area's lighting needs include pedestrian lighting and a transition into park lighting.
- Salem Industrial Drive between Del Webb Avenue NE and Anunsen Street NE: an industrial area with limited streetlighting.

Studio Process

The goal of the Product Design studio course was to provide the City of Salem with a thorough analysis of their current public lighting, and to provide them with a vision of what their public lighting could be. The studio course lasted for ten weeks, from January to March 2011. The project began with a kickoff meeting in Salem, Oregon, on January 14, 2011.

Students split into six groups of three to focus on different types of lighting. Three groups focused on streetlighting, one on park lighting, one on wayfinding, and one on the use of lighting in public transportation. All groups began by doing research on case studies of other cities that have implemented energy efficient lighting solutions, and by comparing the characteristics of different types of emerging lighting technologies with the existing HPS lighting.

The groups then began doing research specific to their areas of focus by conducting surveys on what people like and dislike about the current lighting, taking photometric readings of the current lighting, and analyzing areas for improvement.

Using this information, the groups each identified three major problem areas and began developing solutions. Groups then presented their three areas of interest and possible design directions to the City of Salem for feedback during a midterm review on February 1, 2011 in Eugene, Oregon.

From there, each group chose one major design direction to pursue and began generating ideas and creating prototypes for testing and evaluation. Students presented their final conceptual models,



Figure 1: Students organizing ideas with post-it notes

along with the research and analysis that led up to them, to the City of Salem and its partners from Salem Electric, PGE, and Salem-Keizer Transit, for their consideration at a meeting in Salem on March 10, 2011. The studio enjoyed the opportunity to work with Salem and the challenge of redesigning something as ubiquitous as streetlighting. The studio also benefited from various guest lecturers, including speakers from BCG Tech, Light Beam Industries, and Jill Mulholland, University of Oregon Baker Visiting Professor.

Research

Dark Skies

In redesigning Salem’s public lighting, the Product Design studio was interested in adding reduction of light pollution as another goal of the project. The International Dark-Sky Association (IDA) is a group dedicated to reducing light pollution on the grounds that it disrupts ecosystems, negatively affects human circadian rhythms, and wastes energy. Current HPS lighting is radial as opposed to directional, meaning that it sends light in all directions and is difficult to control. Following the IDA’s design principles, the Product Design studio sought to include reducing the spread of light to areas where it is not needed as a means of reducing the energy use and environmental impact of new lighting designs.

Case Studies

Initial case study research for this project centered largely on alternative power sources and alternative lighting options. Especially in the realm of park lighting, there were numerous instances of lighting systems that ran entirely on solar power, or on a combination of solar and wind power. Additionally, many cities across the country are experimenting with switching to LED lighting and are reporting good results. Some of the key case studies analyzed in this project are discussed below:

LED City Initiative—Anchorage, Alaska

In 2008, Anchorage replaced about 140,000 cobra head streetlight fixtures throughout the city with LED fixtures. The project cost \$2.2 million to implement but is seeing a 50% energy savings compared to the fixtures they replaced. This translates to saving the city \$360,000 a year on energy costs alone.



Figure 2: A section of road lit with LEDs, as compared to the HPS lighting in the distance

In 2010, Anchorage began experimenting with adding dimming technologies to the LED fixtures. Dimmers allow the lights to be on at full capacity during peak traffic hours and dimmed at times when there is little traffic, such as very early in the morning. The addition of dimming technologies is showing energy savings as high as 75% over traditional HPS lighting.

Having validated the extensive energy savings of the project, and having gained overwhelming public approval for the new white LED lights, Anchorage is planning to expand the project and to work to replace the remaining HPS fixtures with LEDs.

Rebuilding Green—Greensburg, Kansas

In 2007, a tornado swept through Greensburg and destroyed much of the city. When the city was rebuilding, they resolved to rebuild green and replaced all 303 of their HPS streetlights with LEDs. Greensburg was one of the first cities in the United States to have 100% LED lighting. The streetlights they chose are 40% more efficient than their previous fixtures, and Greensburg is seeing total savings on energy and maintenance of around 70%.

Solar Park Lighting—Madison, Wisconsin

The community wanted to have lighting installed along pedestrian pathways in Thut Park, but was loath to install traditional lighting due to the expense and disruption of the natural environment that it would cause. Madison Gas and Electric (MGE), known for their interest in green lighting technologies, partnered with the City of Madison and decided to install Carmanah EverGEN 1710 fixtures.

The LED fixtures run exclusively on solar power, and therefore do not require the installation of power lines. The lights operate on a “split night profile,” where the lights operate at full intensity for five hours after dusk, dim to 25% of full intensity during the night, and then return to full intensity two hours before dawn. The lights make the park more usable and enjoyable to the community and will generate environmentally friendly lighting for years to come without any electricity costs.

Dimming Technologies—Albi, France

Albi’s solution to streetlighting was to analyze how people see at night, and to adjust their streetlights accordingly. They found that people require two to three times as much yellow light as blue light to achieve the same level of visual acuity,



Figure 3: Solar-powered lighting installed in Thut Park in Madison, WI

meaning that streets could be illuminated at lower levels without a reduction in visibility.

The fixtures in Albi are dimmable metal halide lights, which dim down to lower levels of light at times of the night when there is less activity. As they dim, they shift down the spectrum to a bluer light so that the level of visibility feels the same. Dimming the lights when bright light isn't necessary reduces light pollution and saves energy.

The fixtures also feature two-way communication so that maintenance problems can be identified immediately and corrected within 24 hours. The two-way communication also enables individual control, so dimming can be done on a fixture-by-fixture basis (e.g. to maintain constant bright lighting at a crosswalk).

“Rethinking Park Lighting” by Carole Lindstrom

This study was directed at park lighting, but the conclusions can be applied to all areas of lighting. Most parks and cities are lit with pole lights, which create pools of bright light and areas of sharply contrasting dark shadows. The study found that while landscape lighting alone was seen as the most attractive lighting option, a combination of landscape lighting and pole lighting provided the greatest feeling of safety. The study concluded that brighter lights were not inherently better. Instead, low levels of more consistent ambient lighting are more effective at creating a feeling of safety and providing better overall visibility. This means that a well-designed system of lighting that operates at lower levels can use less power and be more effective than traditional lighting systems.

Additional case studies used in this project may be found in the individual project books supplied to Salem by each group.

Comparison of Different Lighting Technologies:

Students analyzed and compared a number of different types of lighting options suitable for streetlight use, from the most common to the most cutting-edge. Students chose light bulbs that are considered representative of different types of lighting, on the assumption that models from other manufacturers had similar characteristics. Multiple bulbs from each category (e.g. LED, HPS) were included in the comparison.

Students compared lights based on lifespan, wattage, lumens per watt, color temperature, and color rendering index (CRI). A summary of the lights surveyed is provided on the following page.

Analysis:

- Lifespan: LEDs and induction lighting have similar, extremely long life spans compared to HPS and metal halide bulbs. This means that they have to be replaced less often, which reduces maintenance costs.

Manufacturer	Philips	GE	GE	Global Green	BCG
Bulb Type	HPS	Metal halide	Ceramic metal halide	Induction	LED
Lifetime (hours)	24,000	20,000	22,000	60,000	50,000
Lumens	28,500	30,500	36,000	5,950	3,200
Wattage (W)	250	320	400	85	40
Lumens per Watt	114	95	90	74	80
CRI	21	70	90	80	70
Color Temperature (K)	2,100	3,700	4,200	6,500	2,700 - 7,000



Figures 4 - 8: The pictures correspond to the associated lights listed in the above table

- **Wattage:** Wattage indicates how much energy the bulb is using. An LED at as low as 40 watts is comparable to a standard 250W HPS bulb. As the table shows, LEDs use the least energy of the lighting options available. This makes them the most cost-effective in terms of energy consumption.
- **Lumens per Watt:** This is a measure of the efficiency of the bulb, examining the ratio of light output to energy consumption. While HPS lights had the highest lumens per watt at 114, the other lighting options were all close behind.
- **Color Rendering Index (CRI):** The color rendering index is a measure of how well a light source reproduces the colors of various objects in comparison to natural sunlight. A higher CRI means that the colors are more accurate, and is therefore more desirable. HPS lights have by far the worst CRI of all of the lighting options surveyed, and ceramic metal halides have the best.
- **Color Temperature:** The color temperature indicates the perceived color of the light. Color temperatures below 3,000K are considered warm (yellow to red light), while color temperatures above 5,000K are considered cool (blue to white light). Higher color temperatures provide greater visual acuity, which is especially desirable in streetlighting. LEDs are especially good for color temperature because they can be engineered to have almost any color temperature, ranging from yellow to blue or white.

While LEDs were not the best choice in every category analyzed, their remarkably low wattage requirements and long life spans make them a very appealing option. In addition, their high CRI and adjustable color temperature make LEDs the most versatile and adaptable type of light for different lighting needs. Induction lighting technology has potential, but it is not as mature as LED lighting. Case studies indicated that LEDs were the most readily integrated into existing lighting systems, and their widespread usage has led to improved reliability and reduced costs. Hence, students generally agreed that LEDs were the best lighting option to use in Salem's streetlights.

Site Documentation and Analysis

The Product Design groups made several trips to Salem to see some of the sites that the city had identified as priorities for the project, and to get a sense of the City of Salem and its current streetlighting. Photos were taken during the day and at night.



Figures 9 - 13: Existing streetlights in the downtown area of Salem at night



Figures 14 - 16: Existing streetlights in the downtown area of Salem

The studio groups also took photos around the Eugene area, assuming the lighting conditions would be comparable.

Students were impressed by the sheer number of streetlights, especially in the downtown Salem area. They also noted the great variety of streetlights present.

At night, students noticed that many of the streetlights were extremely bright, which tended to create glare. Another potential issue they noticed was that many businesses provide their own lighting for parking lots and the general grounds of the building, often resulting in redundancy with the city's streetlighting.

Surveys and Interviews

Each group conducted surveys and interviews specific to their area of research so as to gain a better understanding of the residents' needs, and of what they like and dislike about the current lighting. The number of responses varied from survey to survey; in all cases, sample sizes were small, and survey data should be used as directional and not statistically conclusive (sample sizes ranged from a handful to forty responses). The surveys were anonymous, and the spread of responses does not necessarily accurately represent Salem's demographics. The goal of the surveys and interviews was simply to gain insight into general trends. The main findings from the surveys are summarized below. The full text of the groups' surveys and interviews can be found in the groups' final presentation books, which were delivered to the city.

- **Transportation:** The vast majority of people surveyed said that they prefer to drive when traveling at night. The next most preferred method of transportation at night was bicycling, followed by busing and walking. Of those who drive, 35% said they would consider switching to walking, biking, or busing if there were better streetlighting.

- Lighting brightness: Upwards of 80% of survey respondents felt that the current streetlights are bright enough, but many noted that being bright did not equate to being effective. Some noted that the lighting was uneven, creating dark spots and areas of bright light. Others complained that areas felt unsafe or had bad visibility in spite of the streetlighting.

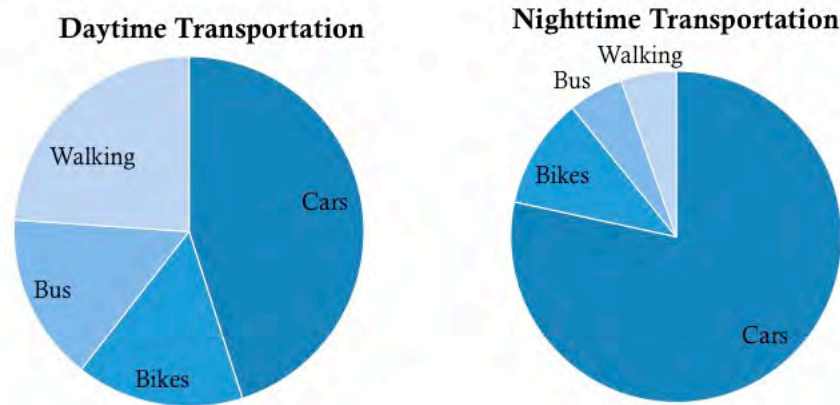

Figure 17: Survey results comparing preferences for daytime and nighttime transportation

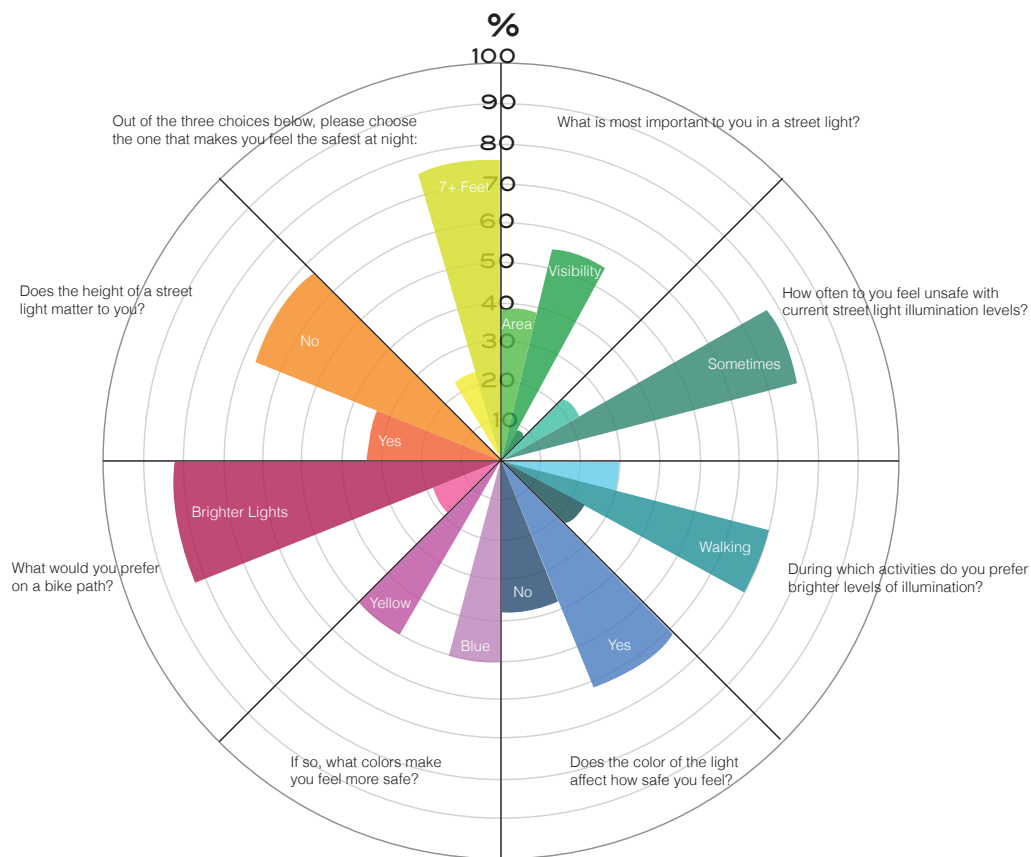

Figure 18: Survey results analyzing residents' preferences for different aspects of park lighting

- **Lighting color:** In every survey where the question was addressed, upwards of 60% of respondents preferred the white light of LEDs to the yellow light of HPS lights. Respondents said they preferred white light because it provided greater visibility and a greater perception of safety.
- **Safety:** Safety was a major theme that emerged in the surveys, in particular visibility when traveling at night. Motorists were concerned about their ability to see others, especially cyclists and pedestrians. Cyclists and pedestrians were concerned with their ability to see others and with their ability to be seen. Survey respondents also expressed concern about the visibility of street signs and road markings in bad weather conditions. A common complaint was that wet roadways reduced visibility and caused glare.

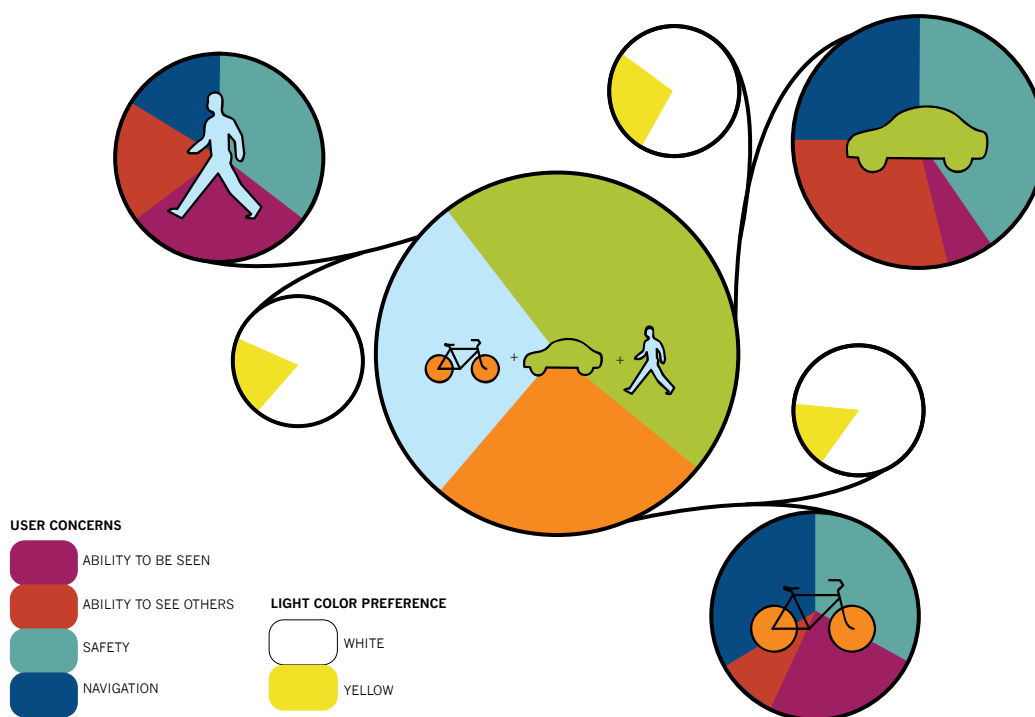

Figure 19: Road safety emerged as a major concern in survey results

- **Cost:** All respondents were unaware of the cost of the current streetlighting. Respondents also had very little knowledge of maintenance needs and costs. Given the option, most respondents said they were open to or in favor of a more energy efficient and environmentally friendly streetlighting solution.

Photometrics

To further analyze the existing streetlights, the Product Design studio used light meters to measure the photometric footprints of streetlights in Salem and Eugene. The streetlights that were measured were chosen at random and represent only a sampling of all of the varieties of streetlighting in Salem.

The photometric footprints of the streetlights analyzed were, however, all very similar. It is therefore reasonable to conclude that problems identified with the streetlights that were analyzed apply to cobra head streetlight fixtures in general.

The studio found that the current streetlights create small areas of extremely bright light, which tends to create glare and cast dark shadows in the surrounding area. They also found that there was still good visibility even after the light meters had a reading of zero foot-candles (a foot-candle is equivalent to one lumen per square foot).

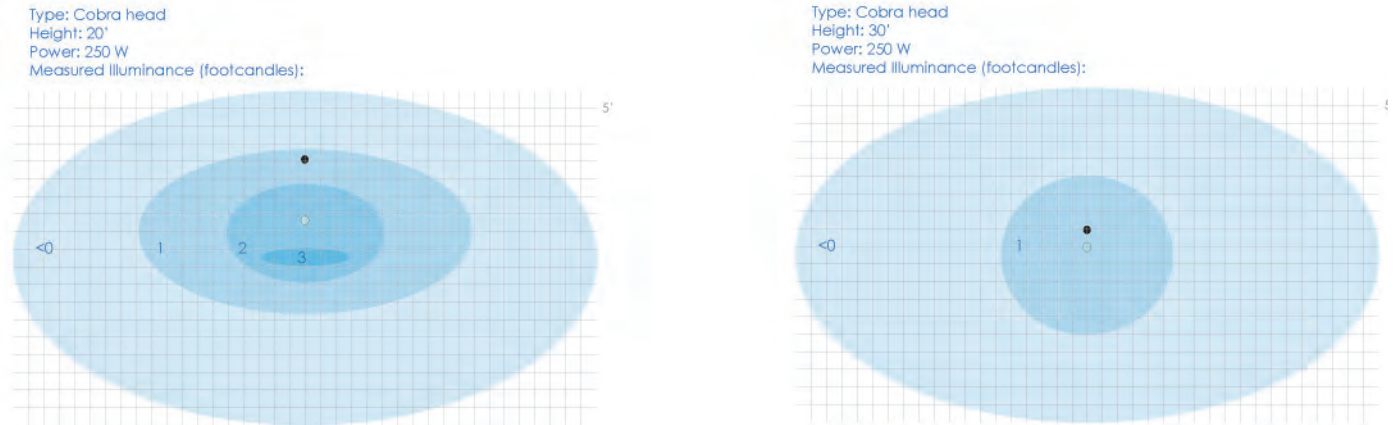

Figure 20: Photometric footprints of two cobra head streetlights measured in residential neighborhoods in Eugene, OR

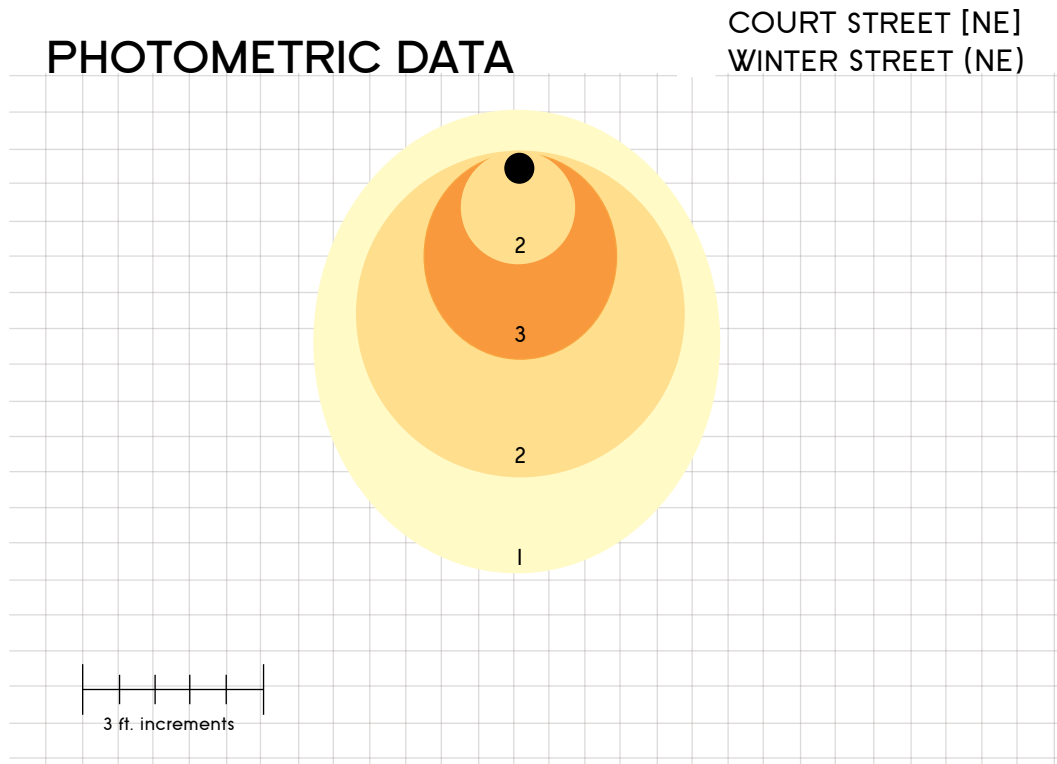

Figure 21: Photometric footprint of a streetlight on the corner of Court Street and Winter Street in Salem, OR

PHOTOMETRIC DATA

COURT STREET [NE]
AT FRONT ST. BY BYPASS

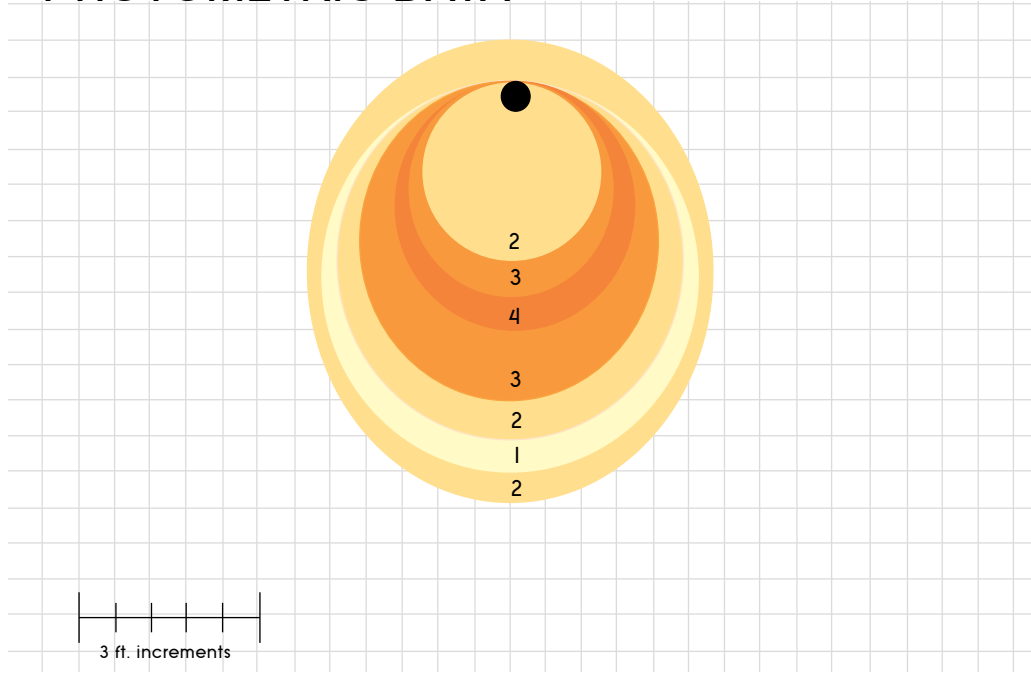

Figure 22: Photometric footprint of a streetlight on Court Street NE at Front Street in Salem, OR

PHOTOMETRIC DATA

COMMERCIAL STREET [SE]
STATE STREET [SE]

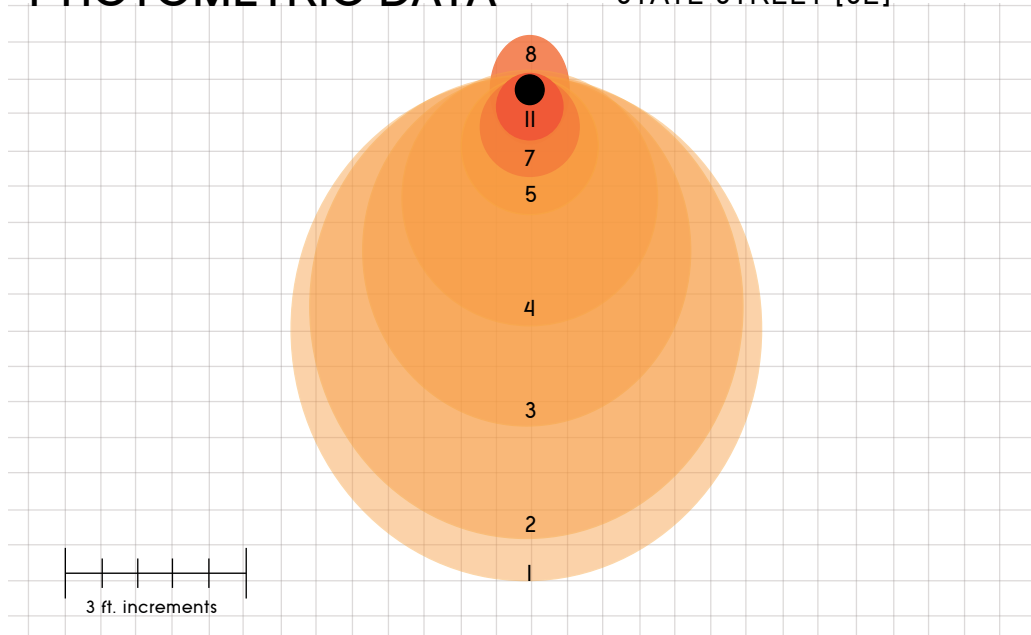

Figure 23: Photometric footprint of a streetlight on the corner of Commercial Street and State Street in Salem, OR

One group compared LED and HPS acorn lamps on the University of Oregon campus, similar to the fixtures used in park and pedestrian lighting throughout Salem. They found that the LED lamp produced a much broader pool of light and a larger area of intense, bright light. They also noted that the falloff for the

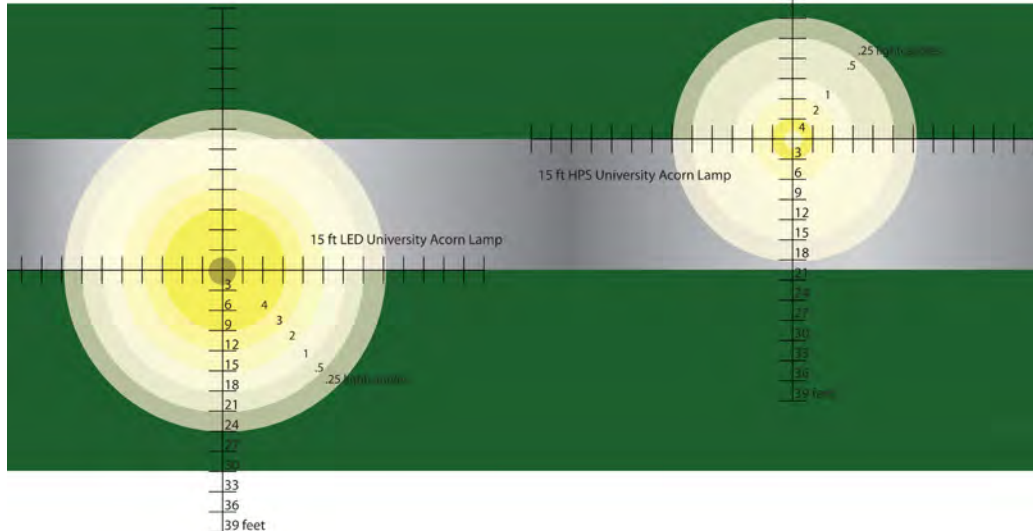

Figure 24: Photometric footprints of an LED and an HPS acorn lamp on the University of Oregon campus in Eugene, OR

LED light was much sharper than that of the HPS light, which is one of the main differences between LED and HPS lighting in general: while HPS light has no defined edge, the light from an LED stops at a certain point, after which it is distinctly dark.

Conclusions and Themes

From the research, the following emerged as major themes:

- Energy costs could be greatly reduced by switching away from HPS lighting
- LEDs are currently the strongest option for replacing HPS lighting
- Current lighting is poorly directed and causes unnecessary light pollution

The main conclusion from the research was that current HPS public lighting is inefficient and, in many cases, not as effective as it could be. After reviewing the case studies, it became clear that new and energy efficient lighting technologies can be successfully implemented and can produce real and substantial cost savings. Specifically, switching from HPS to LED lighting alone could save the City of Salem 50% on their annual streetlighting electricity costs. Whether Salem would choose only to change the type of lighting they use or if they would choose to implement dimming technologies and other energy-saving techniques, it is evident that the city's annual electricity costs could be greatly reduced.

From the analysis and comparison of different lighting technologies, LEDs emerged as the overall best choice. LED technology is fairly well developed and has produced reliably successful results in the cities where it has already been implemented. The Product Design studio thought it seemed a matter of course that LEDs should be used in any new streetlighting Salem might install.

The site analysis, surveys, interviews, and photometric analysis focused on analyzing the current streetlighting and identifying areas for improvement. From these analyses, the need for better lighting direction emerged as a recurring theme. Issues like light pollution, glare, and uneven lighting are caused by poorly directed streetlighting, and the studio sought to create more effective lighting footprints with their designs.

Concepts: Streetlighting

After the research phase of the project, each group in the Product Design studio worked to develop design concepts to address the overarching themes and provide beautiful and long-lasting lighting solutions for the City of Salem.

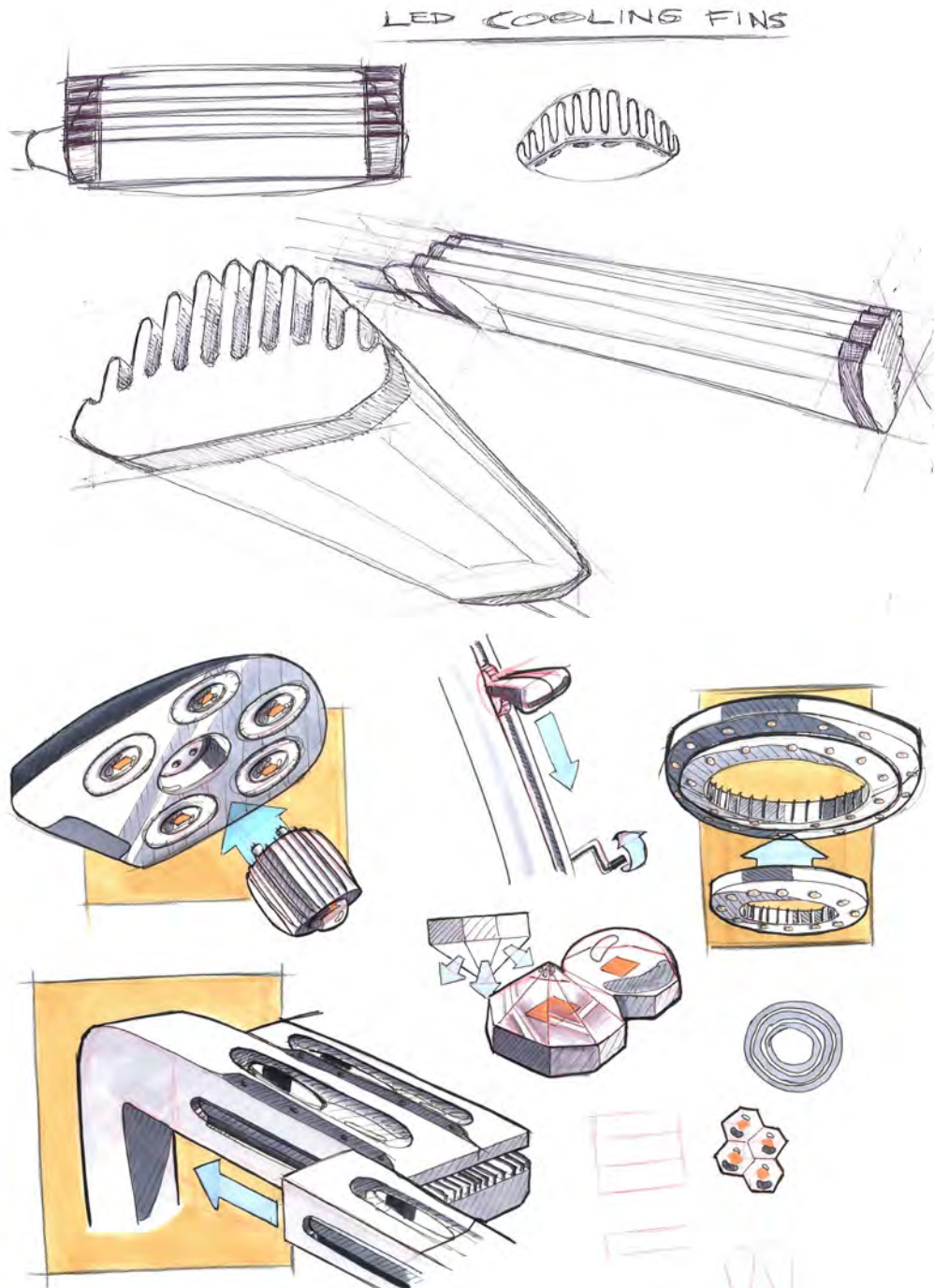

Figures 25 and 26: Initial concept sketches

Group 1: Solar Hybrid Streetlighting

Phill Murff, Alyssa Wasson, Sierra Kuntz

The primary goals of this design were sustainability, increased light in residential areas, and finding the best way to utilize LED technology. The streetlights feature solar panels, creating a fully off-grid lighting system that could eliminate Salem's annual streetlighting electricity costs. This design stretches the light fixtures out down the length of the road, taking advantage of the directionality of LEDs to provide more light where it is needed and less where it is not. These new streetlights are designed to fit on existing light posts, further reducing their impact on the environment.

Current streetlighting uses one bulb to direct light downward, but much of the light radiates out to where it is not needed and causes light pollution and glare. In this design, LEDs are spaced out along a pole to help distribute light across a larger area, down the length of the street. Because of the directional qualities of LEDs, the light can be directed only where needed, and light pollution can be reduced.



Figure 27: Rendering of the group's final design

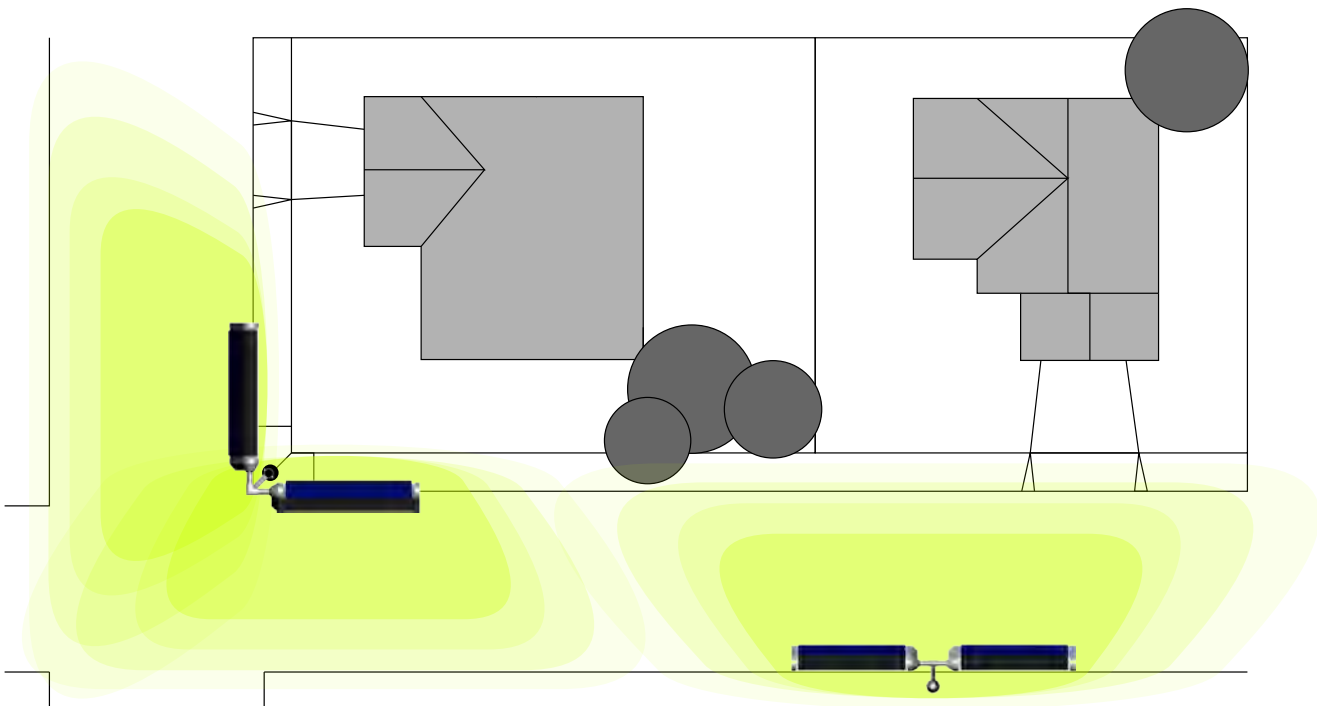

Figure 28: Proposed photometric footprint for the new lighting

The group went through a number of form studies and prototypes to determine the most effective shape for the fixture. It was important that a single fixture be able to light two road lanes, but not light more than necessary. The prototypes were also used to study different lens and louver options to determine the best means of controlling glare.

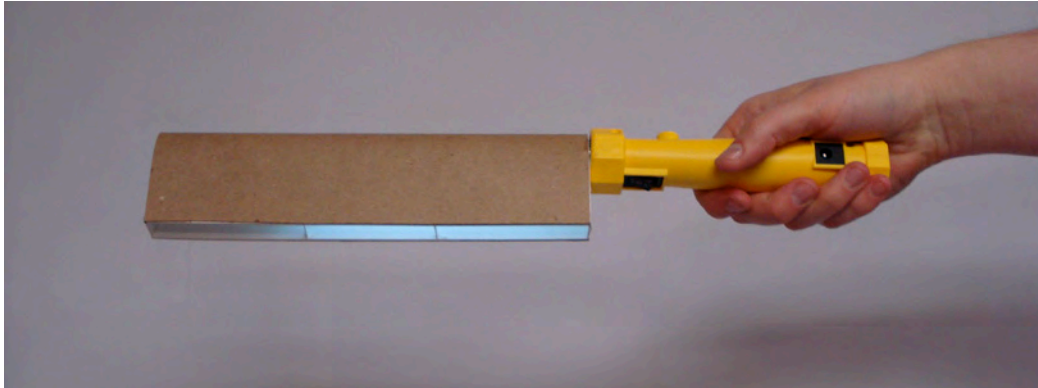

Figure 29: Prototypes were tested with an LED light to see how the various forms altered the spread of light

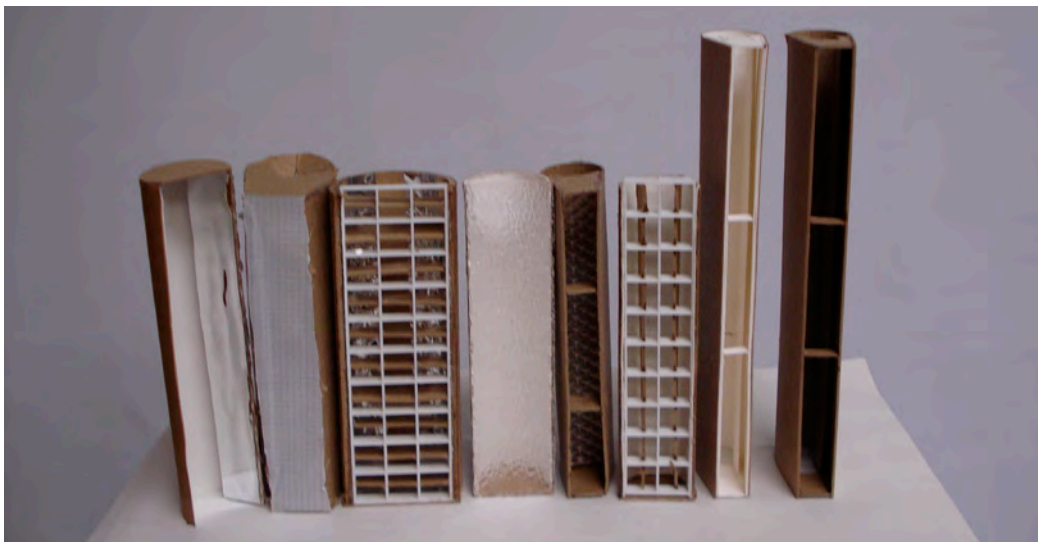

Figure 30: Form explorations

The group was committed to utilizing a sustainable energy source to power the streetlights and chose to pursue solar power after concluding that it was the most viable for Salem. After determining the best proportions for the final fixture, the group integrated solar paneling into the shell of the fixture. The solar panels are adjustable and can be turned to one side of the fixture or the other, depending on which direction the street faces.



Figures 31 and 32: Renderings showing the solar panels on either side of the fixture



Figure 33: Rendering showing how the new streetlights would be laid out on an average street

Group 2: The ViperHead

Zoe Blatter, Liesel Sylwester, Jordan Giboney

The ViperHead is a lighting system designed to use less light more effectively and to provide Salem with flexible streetlighting that can grow and change with the city. It combines pedestrian and street lighting onto one pole and can be configured in a number of ways depending on the site's needs. The fixtures use LEDs, focused into the desired lighting patterns using a variety of lenses. By reducing the number of streetlights and by using LEDs, the ViperHead system will reduce Salem's annual streetlighting electricity costs by 60%.

The lenses will direct light down the length of the street and sidewalk, providing ample light on the roadway while reducing light pollution and glare. The LEDs will provide a lower level of light than current HPS streetlights, but visibility will not be reduced due to the whiter light of the LEDs. Putting pedestrian lighting and street lighting on a single pole will diminish visual clutter and reduce the number of light posts on the average block from 15 to 6.



Figure 34: Rendering of the group's final design



Figure 36: Proposed photometric footprint as it would be applied to downtown Salem

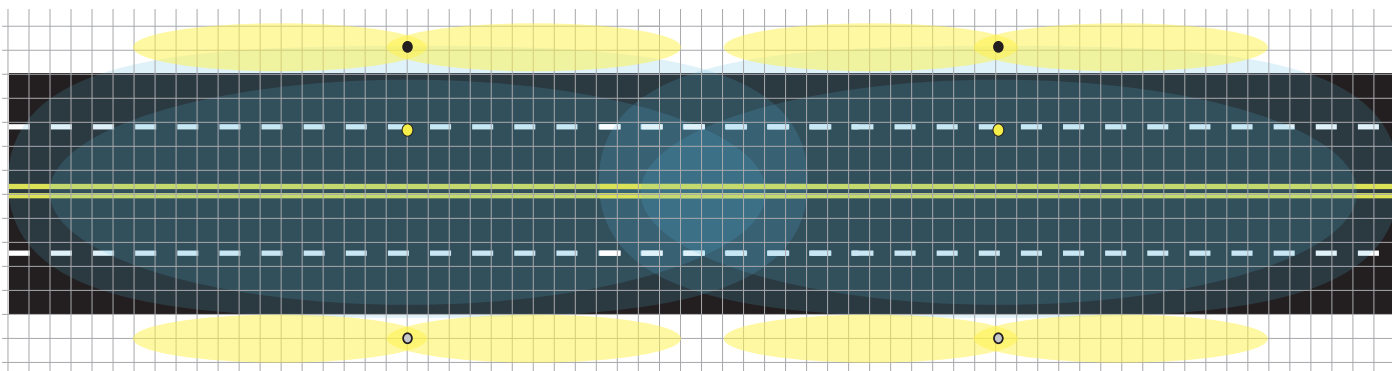
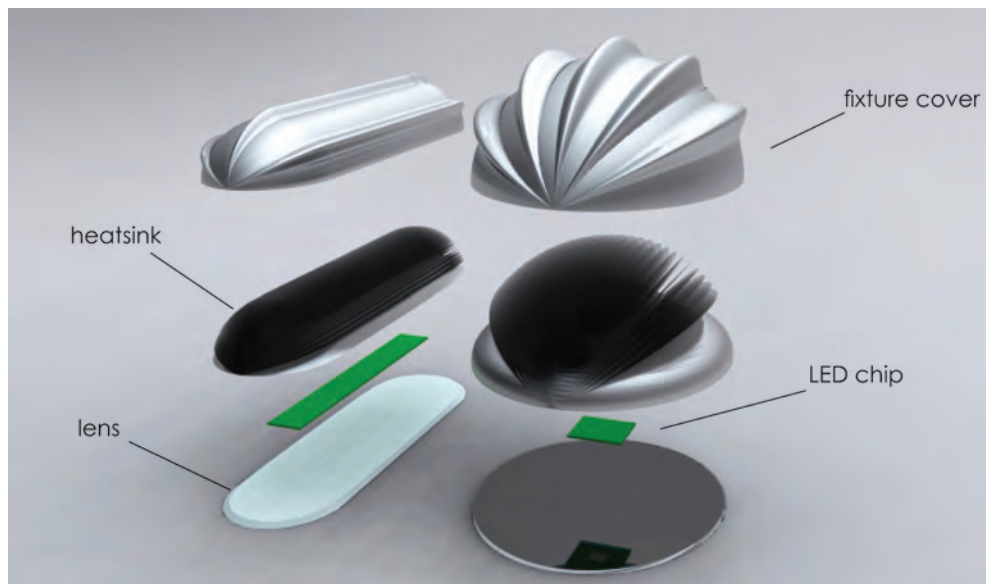
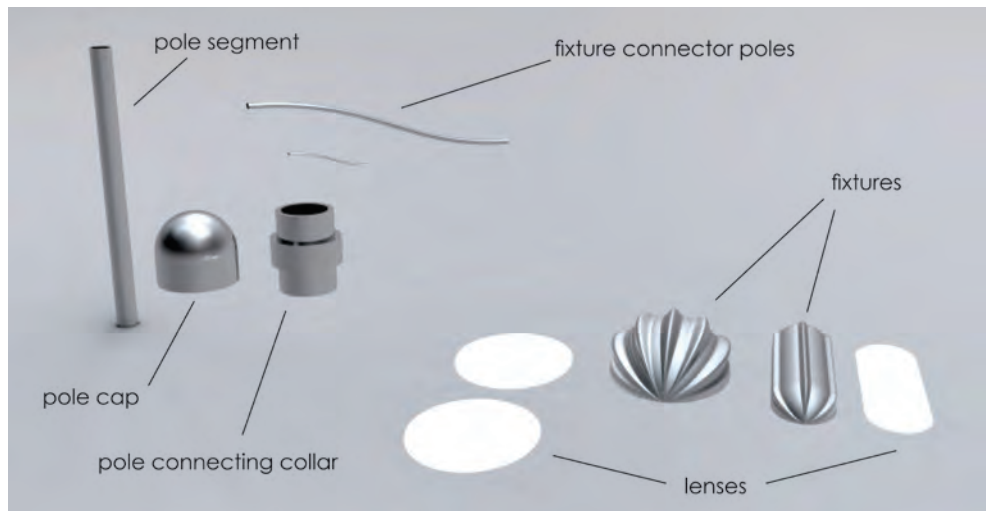

Figure 35: Proposed photometric footprint for the new lighting system

The lighting system has ten components in total: two fixture types, three lens options, 12-foot sections of the main post, three connector pieces that are used to configure the light post, and a cap for the light pole (see Figure 37). The more elongated fixture is designed for pedestrian lighting, with a lens that projects light down the length of the sidewalk. The more rounded fixture is designed for streetlight use, with lenses that may be interchangeable to create either a strong, focused light for intersections or a more diffuse light for the length of the road. The form of the fixtures was guided by the need to contain large heat sinks, which will keep the LED chips cool and ensure their longevity.

The modularity of the system allows it to be easily adjusted as needed. The fixture heads may be attached to existing light poles, and the modular light post sections may be installed as existing poles are replaced in the course of maintenance.



Figures 37 and 38: Components of the ViperHead lighting system, and an exploded view showing the components of the luminaires

Group 5: The M.E. Light

Sarah Morgan, Nathan Eshleman, Kristopher Schaefer

M.E. Light: The Marginal Environment Light. Providing Light for Me.

Motorists want to see others, and pedestrians and cyclists want to be seen. Current streetlights illuminate the center of the roadway, casting little light on pedestrians and cyclists at the margins of the roadway and flooding the center of the road—already well lit with headlights—with excessive glare.

LIGHT NEEDS

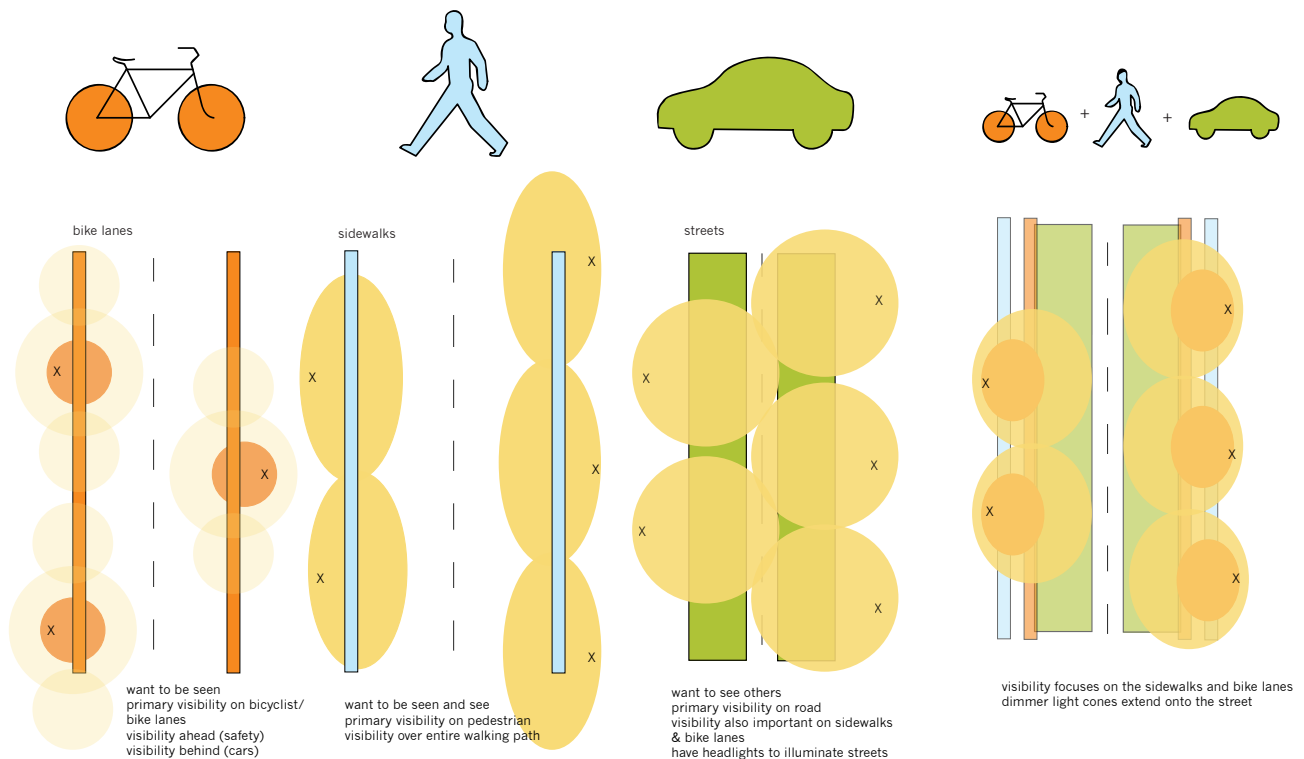

Figure 39: Specific lighting needs for cyclists, pedestrians, and motorists

The M.E. Light moves the lamp behind the sidewalk and casts a horizontal cone of light so that the strongest light falls on pedestrians, and next on cyclists. It also provides a low level of even lighting on the roadway that ensures drivers will be able to see any obstacles that may be present. With the M.E. Light, pedestrians are easily visible, cyclists are well-illuminated, and motorists can see and assess their environment more easily.

The light is mounted 15 feet high on existing lamp posts. The lower height feels comforting to people, and it also allows for easier and safer maintenance. Positioning the light over the sidewalk enables maintenance workers to service the light without stopping traffic or requiring flaggers.

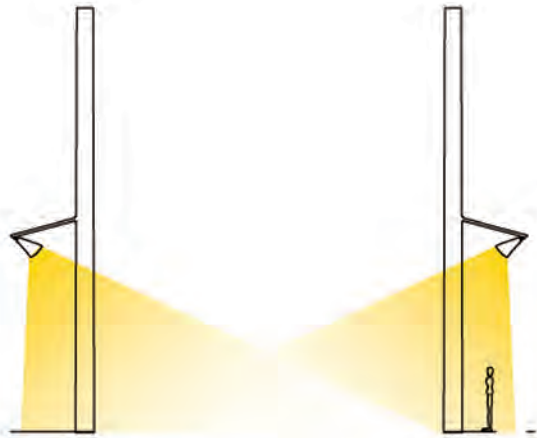

Figure 40: The M.E. Light directs more light to the sidewalk, where it is needed



Figure 41: The M.E. Light is mounted closer to the ground than traditional streetlighting



Figures 42 and 43: Renderings of the group's final design

Concepts: Parks and Public Spaces

Group 3: The MELAS

Damien Menard, Charlie Hartzell, Ian Kenny



Figure 44: Rendering of the group's final design

Research shows a direct link between the health of urban residents and the accessibility of its parks. Park lighting is essential, because many people work during the day and can only fit in a nighttime stroll. The MELAS park lighting system is designed to provide even, glare-free lighting and a sense of safety that encourages nighttime park use.

The aesthetics of the MELAS system respond to its environment, going beyond typical acorn lamps. The arms of the luminaires echo the branches of a tree, and the luminaires themselves were inspired by leaves. The branching form of the luminaires also maximizes surface area and airflow, keeping the powerful LEDs cool and ensuring their

longevity. The fixtures are designed so that there can be anywhere from one to five luminaires on a single pole, depending on each area's unique lighting needs.



Figures 45 and 46: A model of the MELAS was milled out of foam on a CNC router

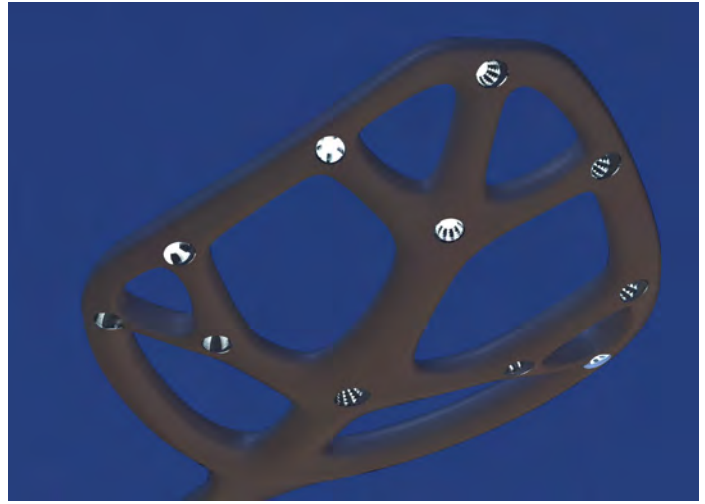

Figures 47 and 48: A small model of the MELAS with all five luminaires. The MELAS light is lit with multiple small LEDs instead of a single light source

The MELAS luminaires contain multiple small LEDs, and the gentle curve of the luminaire spreads the light over a wide area while minimizing glare. The use of multiple small LEDs is designed to create a “Christmas light effect,” creating a soft glow of light with no single distinct source.



Figure 49: The MELAS light as it would look in a park

The use of LEDs alone should reduce the cost of park lighting by over 50% per month. The MELAS system also incorporates smart lighting technology, which reduces costs even further. With smart lighting, base lights on the lamp posts are always on at night to signify that the park is open. When a person enters the park, motion detectors activate the main lights to create a well-lit path. The lights dim slowly behind the person, dimming to 50% brightness after ten minutes. With smart lighting, the park is more brightly lit when there are more people present, and electricity use is minimized when the park is sparsely populated.

Group 4: Wayfinding

Risa Beck, Danielle Thireault, Patrick McAffrey

This park lighting system was designed in part as a wayfinding system. The group focused on the Riverfront Park area in Salem, but the lighting system could be applicable to any park. The front of each luminaire features a map of the park, etched into the steel face, with the luminaire's specific location illuminated so that people will know where they are in the park. It is designed to help first-time visitors and people unfamiliar with the park feel comfortable and safe, and for visitors to be able to confidently navigate their way through the park at night.



Figure 50: Luminaires provide path lighting and navigation

Another goal of this lighting system was to reduce light pollution. This was accomplished by lowering the height of the luminaire to 8 feet tall, and by designing it to provide directional light instead of radial light. This means that the luminaires will focus light on the paths in the park, and not cast light in directions where it is not needed. In this lighting system, only the front of the luminaire is lighted. It is covered in frosted glass to provide a soft glow, and features a small circle of light, indicating the luminaire's location on a map of the park. The luminaire is flanked by translucent concrete veins, lit from the base of the luminaire, that indicate the path boundary. Translucent concrete is a variety of concrete that contains small optical glass fibers that allow light to transmit through the concrete without any loss of structural stability.

Three 12-watt, 24-volt LEDs located in the base light the entire fixture. The LEDs can be accessed through a removable metal plate on the back of the luminaire, allowing for easy maintenance that does not require special equipment. To further make this lighting system sustainable, the face and main body of the luminaire are made from recycled Corten steel.

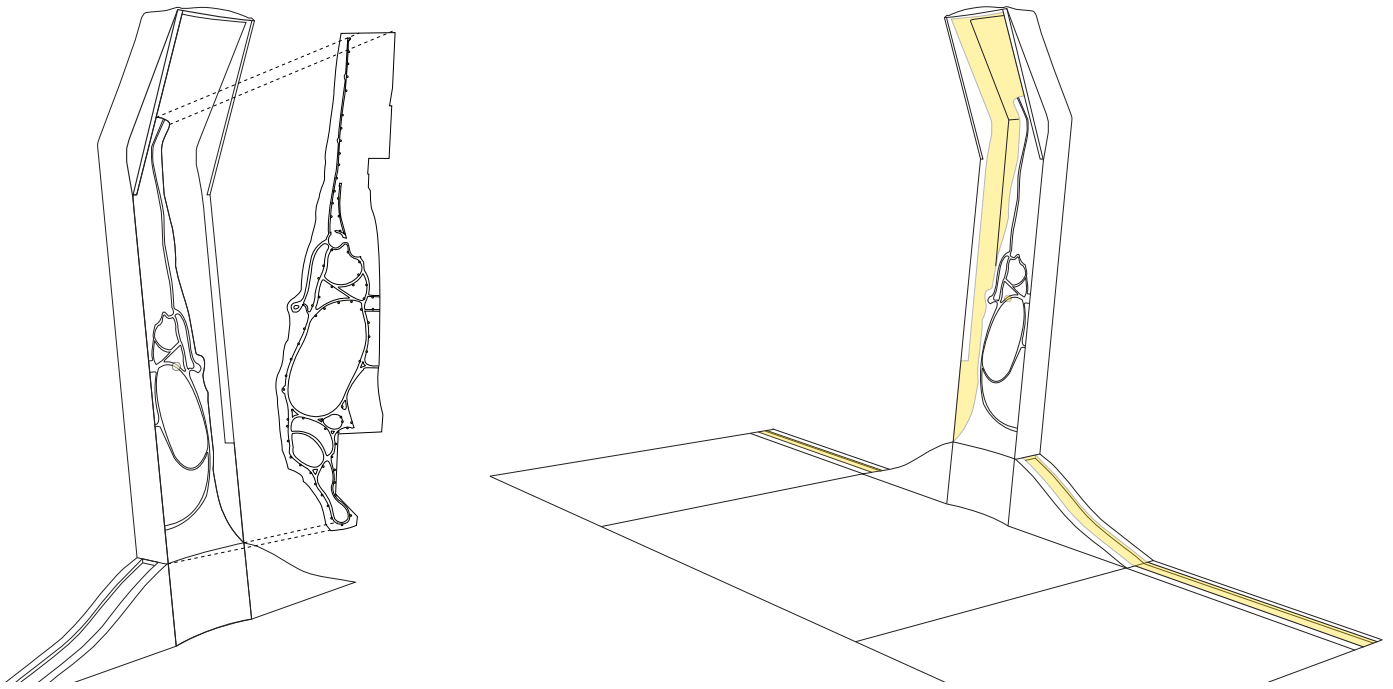

Figures 51 and 52: A map of the park is etched into the face of the luminaire. The lighted areas of the luminaire are highlighted in yellow.

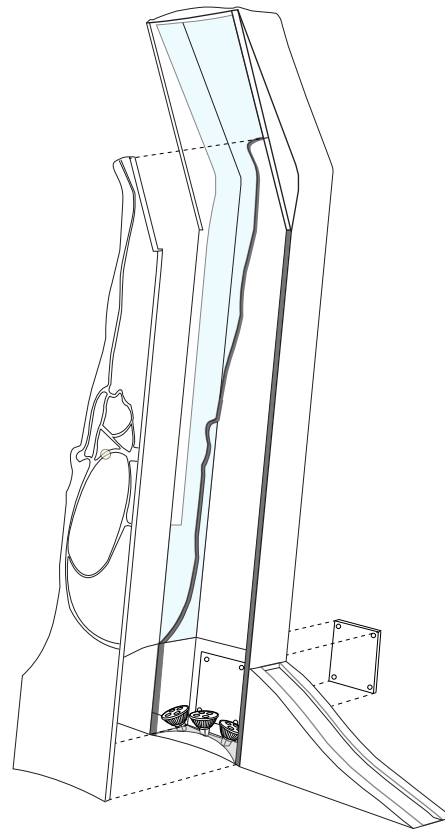
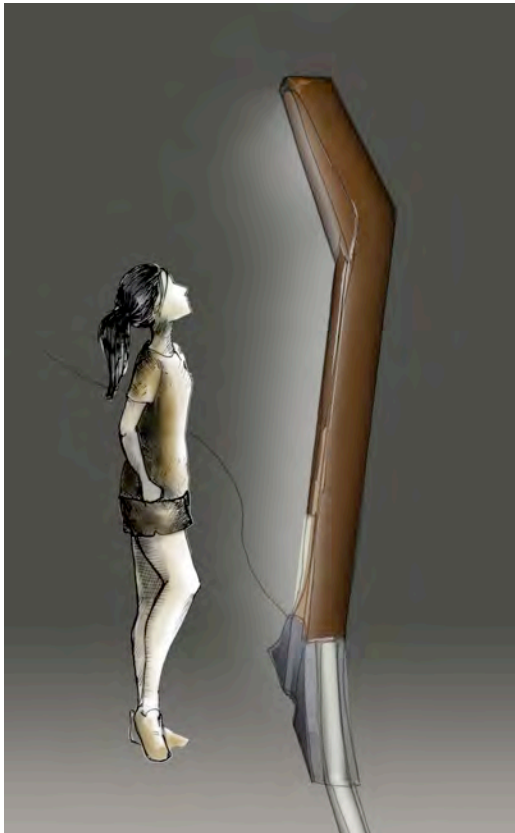

Figures 53 and 54: The luminaire directs light predominantly onto the path, reducing light pollution. Exploded view showing the various components of the luminaire.

Concepts: Public Transit

Group 6: Solar-powered Bus Stops

Kara Williams, Tara Nielsen, Tori Russo



Figure 55: Rendering of the group's final design



Figure 56: Model of the group's final design

Through observing bus stops in both Eugene and Salem, this group found that most bus stops are in areas with little public streetlighting. This can make it difficult for the bus driver to see people waiting at the stop, and the lack of light can make the area feel unsafe. The goal of this design was to enhance communication between the bus patrons and the bus driver, and to create a safe, comfortable space using light. The units are lit with LEDs and are solar powered, making it easy to install them independently and move them as bus routes change.

The design incorporates a two-setting light source that uses one 10-watt and one 28-watt LED to facilitate communication between the bus patrons and the bus driver. When there is no one waiting at the stop, only the 10-watt LED remains on. The 28-watt LED is activated by the bus patron at the push of a button, signaling to the driver that there is someone waiting at the stop. The light dims back to the 10-watt LED after the bus has passed. The light is an "up-light," which directs the lights upward and bounces the light off of the underside of the structure's roof and back down to the ground. This creates a soft, pleasant light and reduces glare.

The units are designed to have a minimal structure so as to reduce their visual impact in residential neighborhoods, and they are only a foot wide at the widest point. The roof of the structure is covered in solar panels, which generate enough energy to power the lights. The angled design of the roof is made to better capture sunlight and improve the efficacy of the solar panels. The battery, LEDs, and the thermal management chip for the LED are all housed in the enclosed area just below the roof. Because the units are completely solar powered and off-grid, they can be installed quickly and easily and moved as needed.

The hope is that bus ridership will be encouraged by providing a better experience for patrons waiting at bus stops.



Figures 57 and 58: The two-dim system saves energy by dimming to a lower level of light until a bus patron presses the button to activate the brighter light

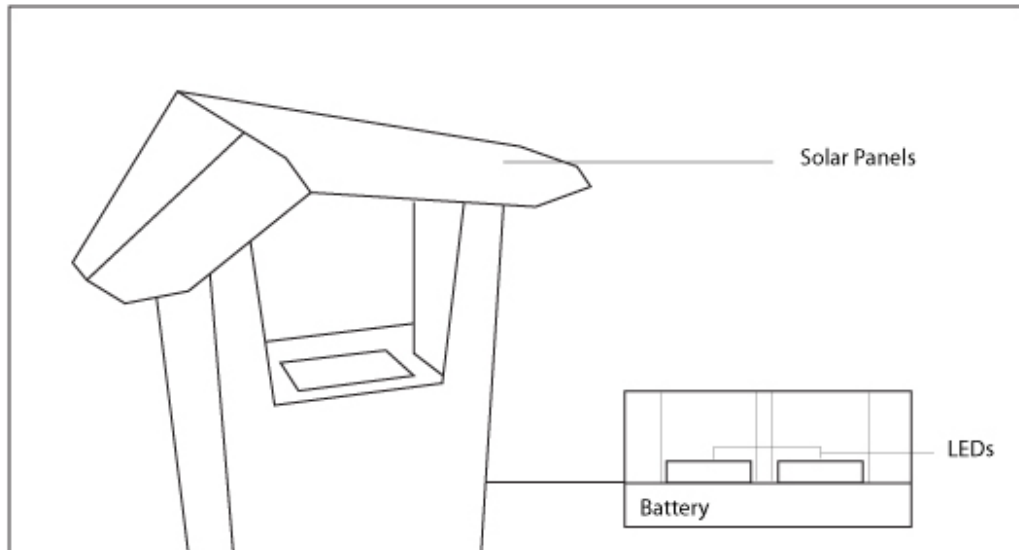

Figure 59: Solar panels cover the roof of the unit, while the battery and LEDs are stored just below

Conclusions

Salem's goal for this project was to gain insights into areas for improvement in their current public lighting, and to come away with design concepts that would promote conversations about the future of lighting and lighting needs in their community. In particular, Salem was interested in exploring energy- and cost-efficient lighting options.

In the course of their work, the students in the Product Design studio analyzed current streetlighting using a variety of methods, including photometric documentation along with surveys and interviews with residents. They also researched case studies of other cities that have implemented energy-efficient lighting solutions, and completed comparison studies between different types of lighting technologies. Through this research, a number of areas for improvement became apparent.

First, the Product Design studio recommends that Salem switch from HPS to LED lighting. This could reduce the lights' energy consumption by up to 50%, and the whiter light of LEDs could provide better visibility and a greater sense of safety. LEDs also have a much longer lifespan than HPS bulbs, reducing maintenance costs and material waste. While LEDs are expensive to install, the studio believed that it would be worth the investment. Though the design groups presented Salem with ideas for completely redesigned light fixtures, retrofitting existing fixtures with LEDs is another option that may serve Salem well.

Another issue the Product Design studio felt strongly about was inconsistent lighting and light pollution. The studio addressed this issue with their light fixture designs, combining the directionality of LEDs with new luminaire designs to direct more light where it is needed and less light where it is not. While solving the issue of light pollution and poor light direction is rather complex, it is not impossible. The students' design concepts all addressed these problems and provided Salem with examples of potential solutions. The Product Design studio also encouraged Salem to find a way to improve lighting direction in any new streetlighting they might implement. In addition to better serving the needs of residents, better lighting direction can reduce energy consumption.

A challenge of the Product Design studio was to consider streetlighting as though it were being started from scratch. While they were in many ways restricted to the existing power grid and lighting infrastructure, it was important to consider how well the existing infrastructure serves Salem's public lighting needs. Off-grid lighting is an attractive option, both for its energy efficiency and its flexibility. The off-grid concept also has potential as a hybrid solution, and could be used to augment grid electricity and reduce electricity costs. While current solar technology might not be the most effective option in Salem's climate, the studio was in favor of off-grid lighting and recommends that Salem keep it in mind as an option as off-grid energy technologies continue to develop.

Each group in the studio presented Salem with its own unique design concept and encouraged Salem to imagine the boundaries of what is possible. From solar power to modularity to completely re-imagined park lighting, the studio offered Salem inventive lighting solutions designed specifically for the city's needs. The Product Design studio enjoyed working with Salem and hopes that Salem found their ideas to be thought-provoking. We hope that Salem will use the groups' design concepts to further their goal of efficient streetlighting.

Appendix

This section contains the final posters presented to the City of Salem and its electric utility partners by each group in the Product Design Studio.

THE VIPERHEAD

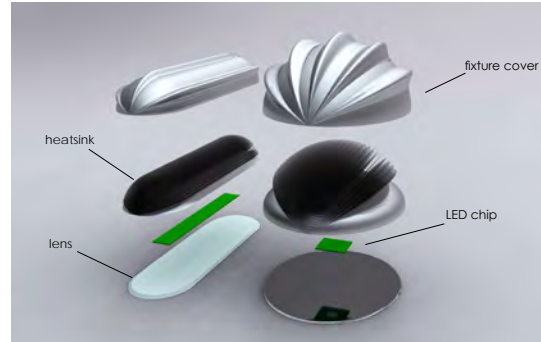
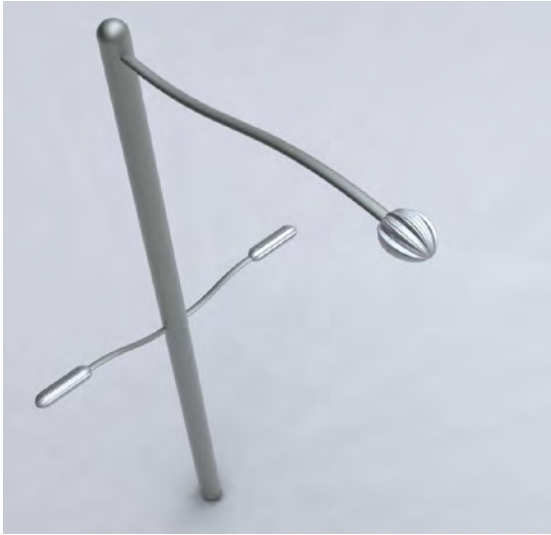

MODULAR STREETLIGHTING

Making streetlighting modular means that lighting can change with the city's changing needs. It combines pedestrian lights and street lights on one pole, reducing clutter and the number of fixtures to maintain. The ViperHead can be configured to serve the needs of anything from a residential neighborhood to a multi-lane thoroughfare. Maintenance is made simpler by having only a handful of parts to keep track of.

The ViperHead system consists of just 10 pieces in total—two fixture types, three lens options, 12' sections of the main post, and four connector pieces that are used to configure the light post. The more elongated fixture is designed for pedestrian lighting, with a lens that projects light down the length of the sidewalk. The second fixture is designed for streetlight use, with lenses that may be interchanged to create either a strong, focused light for intersections or a more diffuse light for the length of the road.

The lights themselves are LEDs, with the fixture acting as a heat-sink to ensure the longevity of the luminaire. The use of LEDs will reduce energy use, and the more direct light they provide will reduce light pollution.

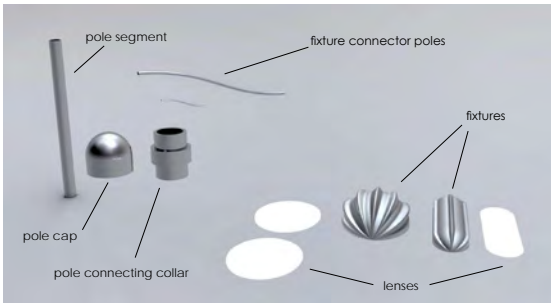

BENEFITS

The primary goal of this design is to use less light more efficiently. The proposed lighting plan for the ViperHead system will reduce the number of light posts per block from 15 to 6—a 60% reduction, achieved largely through eliminating the need for separate pedestrian light poles. The number of actual light fixtures will remain roughly the same. The ViperHead system uses LEDs, which use approximately half as much energy as standard HPS bulbs and last at least twice as long. This will result in considerable energy cost savings, as well as saving on maintenance and replacement costs.

A modular system like this one will also make replacing broken or damaged fixtures easier and more cost-effective. If a pole is damaged in an accident, the section that is damaged can be replaced without having to replace the entire pole.

Zoe Blatter, Jordan Giboney, Liesel Sylwester

Figure 60: Group 1 final presentation

Salem Street Lighting: SCY

Site Visit:



Problem Statement:

The city of Salem is lacking a consistent lighting style, they have over 8,600 street lights in at least 50 different styles. We wanted to design a light that could replace all current styles, except acorn and gas lamps, with a more energy and light efficient design. We also sought a design that would increase the amount of light produced to address the demand for more residential lighting.

Design Process:

Sketches:

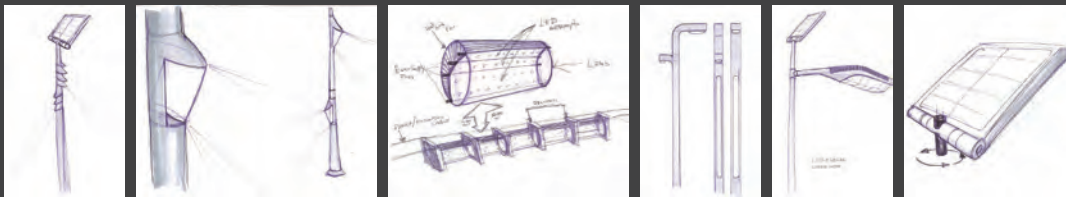

Prototypes and Testing:

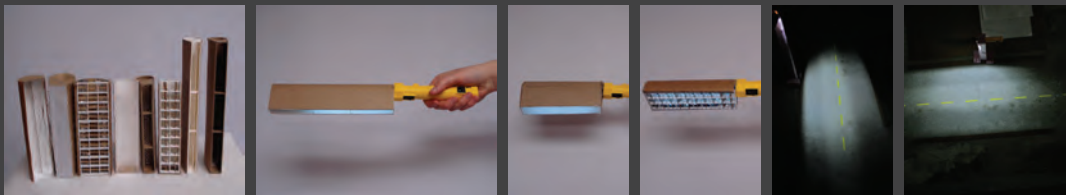

Final Renderings:

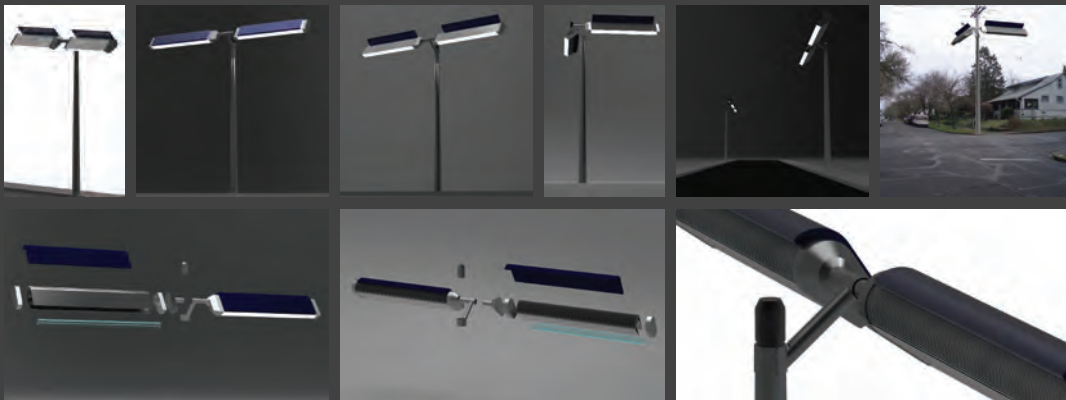

Summary:

The final concept is a modern design that incorporates LED's, solar panels and the use of existing light poles. This would address the two main concerns, sustainability and cost reduction. Each solar panel can be adjusted to the optimum angle for maximum sun exposure. The light housing was designed to take advantage of directional lighting and provide an even luminosity throughout the streets and eliminating hot spots.

Phill Murff . Alyssa Wasson . Sierra Kuntz

Figure 61: Group 2 final presentation

RESEARCH

RUSSEL ERIC
 +MID 20's
 +RUN AT NIGHT BECAUSE OF WORK
 +MAIN CONCERN: CLARE

OFFICER GORDON
 +SALEM POLICE
 +PATROLS PARK AREAS
 +THINKS LED

JANE MEGAN
 +EARLY 20's
 +WALK IN THE PARK TO GET FRESH AIR
 +MAIN CONCERN: SAFETY



BEAUTY

why parks?
 research has shown a direct link between the health of people in a city and the accessibility of parks. Many people work during the day and can fit in a nighttime stroll.



CONTOURED
 The gentle curve of the luminaire evenly spreads light over a wide area, while minimizing glare

BREEZY
 Branching form maximizes airflow, keeping the powerful LEDs cool.

BRAINS

SMART LIGHT

+base lights always stay on to signify that the park is open

+Poles signal a persons whereabouts to other poles creating a well lit path ahead

+lights dim slowly behind the person to allow the park to be fully lit when crowded.

+10 minutes after person has passed. lights at 50% dim.

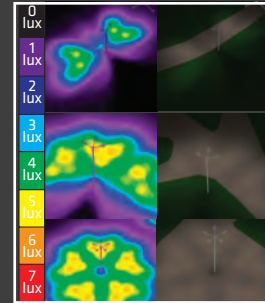

GUTS

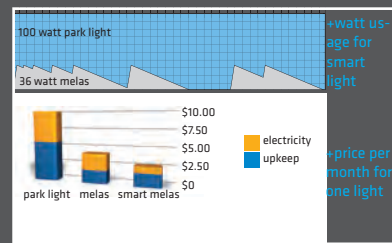

PROCESS



Figure 62: Group 3 final presentation

Hey mom, I'm going for a jog!



Okay honey, just be careful. It's getting dark and you don't know the neighborhood yet!

With that Julia decided to go on a short run around riverfront park. It was soon dusk.

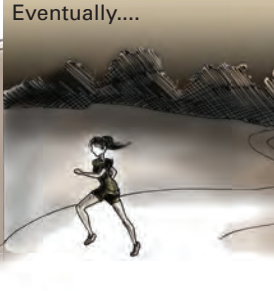

Eventually....



Oh no! Where am I!?!....



which is the right way...?

lost in riverfront park, julia began to panic.

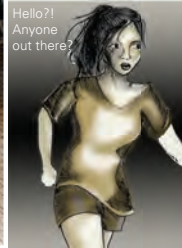

Hello?! Anyone out there?

Detecting a glow, Julia stumbled upon a curious sight — light from an unexpected source.



What is this?? It's glowing...



Julia approached the source, found all the info she needed, and made her way back home, safely.



Finding The Way

Risa Beck, Danielle Thireault, Patrick McAffrey
PD 484 winner 2011 / SCY Salem

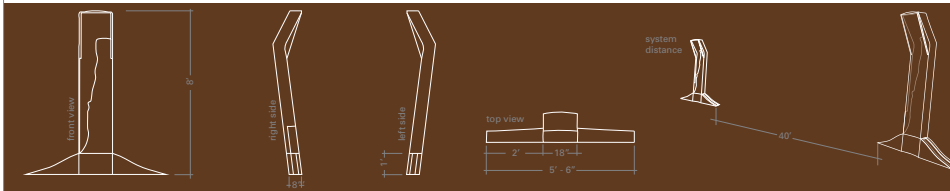
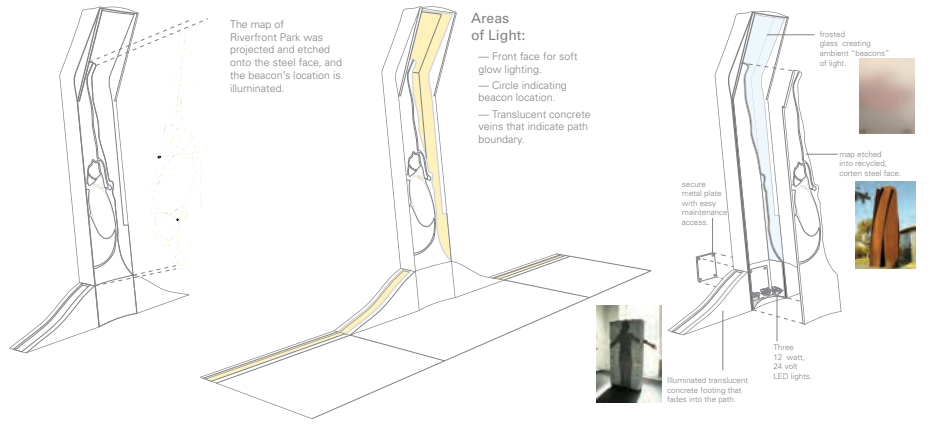

Figure 63: Group 4 final presentation

M.E. LIGHT

Marginal Environment Light. Providing light for me.



Street light users include **cyclists**, **pedestrians** and **drivers**. Current streetlights attempt to address all needs in general and fail to satisfy any of the needs fully. Through identifying the needs of each user group our luminaire uses less light that is strategically placed.

Drivers want to see others. **Pedestrians** and **bicyclists** want to be seen.

Current lights illuminate the center of the roadway. The pedestrians and cyclists who want to be seen receive little if any light causing them to feel unsafe. The drivers strain to see the vulnerable users in the margin, while the road in front, already well lit by headlights, is flooded with excessive glare.

LIGHT NEEDS

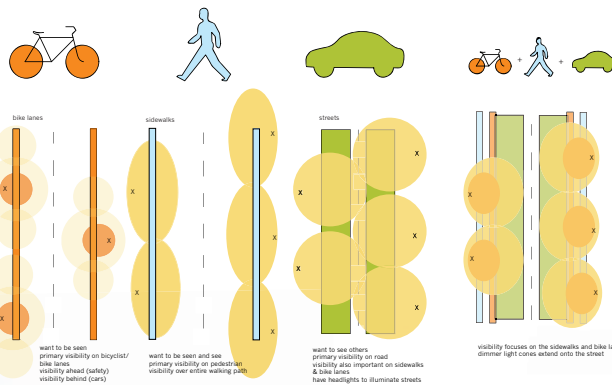

By moving the lamp behind the sidewalk and casting a horizontal cone, the strongest light falls on the pedestrians first and on the cyclists next. Lastly, a safe level of even lighting ensures all in-road obstacles are seen.

Pedestrians are easily visible, **cyclists** are well illuminated, and **car drivers** can see and assess the entire environment more easily.

The less visible user (city and maintenance crew) are also considered. The light, mounted at 15 ft., feels comforting and considered to the people, but also allows for maintenance with a ladder in place of a cherry picker. This height also halves the power required for illumination and the over sidewalk location allows for maintenance without stopping traffic and utilizing flaggers.

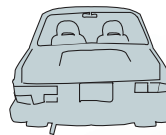

SARAH MORGAN
NATHAN ESHLEMAN
KRISTOPHER SCHAEFER

SCY PD STUDIO WINTER 2011

Figure 64: Group 5 final presentation

MISSION STATEMENT

Through observing bus stops, we realized that lighting for bus riders is typically not considered, as we found that most bus stops are placed in areas that had very little public street lighting. This insight led us to take a closer look at bus stops in Eugene and Salem and consider the attributes that would make bus stops more visually appealing while also enhancing the safety and performance for users.

The goal of our design is to enhance communication between the user and the bus driver by capitalizing on LED technologies and a lighting concept based around a two-dim system. We wish to provide adequate public lighting and in doing so develop minimal but meaningful differentiation in lighting facades across the city of Salem.

RESEARCH AND DESIGN BY

KARA WILLIAMS
TORI RUSSO
TARA NIELSEN

PRODUCT DESIGN STUDENTS OF THE UNIVERSITY OF OREGON

PUBLIC TRANS. LIGHTING

PUBLIC TRANSIT LIGHTING SYSTEMS FOR THE CITY OF SALEM, OR



PROBLEM STATEMENT/



RESIDENTIAL AREAS OF SALEM ARE IN NEED OF A LIGHTING SOLUTION WITH A MINIMAL STRUCTURE THAT PROVIDES ADEQUATE LIGHT FOR USERS, A FORM OF COMMUNICATION BETWEEN USER AND BUS DRIVER AND MOBILITY FOR THE REMOVAL AND INSTALLATION OF FUTURE BUS AMENITIES.

DESIGN OBJECTIVES/

1. SUFFICIENT DIRECTIONAL LIGHTING
2. CREATE A SAFE, COMFORTABLE SPACE USING LIGHT
3. UTILIZE SOLAR POWER TO CREATE INDEPENDENT UNITS
4. FORM OF COMMUNICATION BTWN BUS AND PATRONS



BENEFITS OF LED'S
-LONGER life span than HP
-clear and clean directional light
-efficient light source with out the dimming over time with HP
-createS a workable budget

LED SOURCE



CONVENIENT HEIGHT TO ALLOW USER TO OPERATE WITH HIP OR OTHER EXTREMITIES

USER OPERATED LIGHT

LIGHTING PLAN

ELEVATION VIEW

TOP VIEW



USER SCENARIO
TWO DIM LED

1. OPERATES AT ALL DARK HOURS
2. USER OPERATED LED FOR COMMUNICATION

BENEFITS OF OFF-GRID

-contribute to sustainability
-MOBILE units that can be moved and installed **independently**
-enhanceS your city's image
-createS a workable budget

SOLAR POWERED

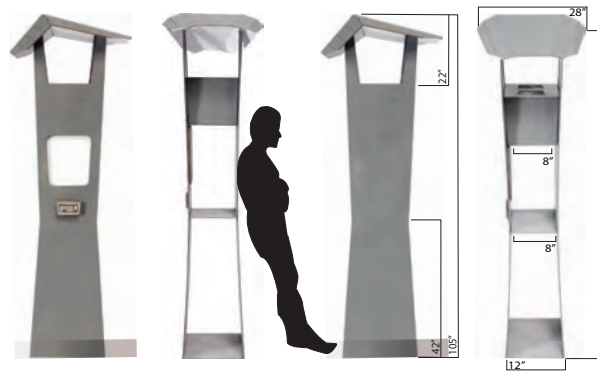

Figure 65: Group 6 final presentation

References

Case Studies:

Anchorage, Alaska: <http://www.ledcity.org/Anchorage.htm>

Greensburg, Kansas: <http://greensburg.buildinggreen.com/overview.cfm?ProjectID=1395>

Madison, Wisconsin: http://www.carmanah.com/portals/1/docs/case_studies/CAS_GI_MGE.pdf

Albi, France: <http://www.sparling.com/SparAdmin/arts/DBF%20LD+A%20Sustainable%20Street%20Light.pdf>

Rethinking Park Lighting: <http://www.landscapeonline.com/research/article.php?id=5135>