



Green Cities

Fall 2010 • Planning, Public Policy and Management

Heather Cyrus • Environmental Studies

Suni Dillard • Architecture

Robert Young • Assistant Professor • Planning, Public Policy and Management

Acknowledgements

This report is part of the University of Oregon's Sustainable City Year focusing on the City of Salem, Oregon. The Green Cities team would like to extend appreciation to those involved in the SCY project. Thank you to the City of Salem and Salem City Manager Linda Norris, for the willingness to work with SCI towards a sustainable urban future. Thank you to the Salem Housing Authority staff, with a special thank you to Andy Wilch and Nicole Utz, for your time, care, and dedication to these projects, and for the student support you provided.

Thank you to the Department of Planning, Public Policy and Management, and the Environmental Studies Program, both of which are dedicated to sustainable development and fostering in students a sense of stewardship and care for the future of our cities, communities, and green spaces.

A special thank you to Professor Robert Young and the assistance of Graduate Teaching Fellow Sharon Wade Ellis, and their efforts in leading the Green Cities course. Professor Young not only provided Green Cities students the necessary knowledge, tools, and support for this project, he also instilled in us a sense of empowerment through his enthusiasm, passion, and vision, to make a positive contribution towards a sustainable, healthy, and enriched urban future.

About SCI

The Sustainable Cities Initiative (SCI) is a cross-disciplinary organization at the University of Oregon that seeks to promote education, service, public outreach, and research on the design and development of sustainable cities. We are redefining higher education for the public good and catalyzing community change toward sustainability. Our work addresses sustainability at multiple scales and emerges from the conviction that creating the sustainable city cannot happen within any single discipline. SCI is grounded in cross-disciplinary engagement as the key strategy for solving community sustainability issues. We serve as a catalyst for expanded research and teaching, and market this expertise to scholars, policymakers, community leaders, and project partners. Our work connects student energy, faculty experience, and community needs to produce innovative, tangible solutions for the creation of a sustainable society.

About SCY

The Sustainable City Year (SCY) program is a year-long partnership between SCI and one city in Oregon, in which students and faculty in courses from across the university collaborate with the partner city on sustainability and livability projects. SCY faculty and students work in collaboration with staff from the partner city through a variety of studio projects and service-learning courses to provide students with real-world projects to investigate. Students bring energy, enthusiasm, and innovative approaches to difficult, persistent problems. SCY's primary value derives from collaborations resulting in on-the-ground impact and forward movement for a community ready to transition to a more sustainable and livable future. SCY 2010-11 includes courses in Architecture; Arts and Administration; Business Management; Interior Architecture; Journalism; Landscape Architecture; Law; Planning, Public Policy, and Management; Product Design; and Civil Engineering (at Portland State University).

About Salem, Oregon

Salem, the capital city of Oregon and its third largest city (population 157,000, with 383,000 residents in the metropolitan area), lies in the center of the lush Willamette River valley, 47 miles from Portland. Salem is located an hour from the Cascade mountains to the east and ocean beaches to the west. Thriving businesses abound in Salem and benefit from economic diversity. The downtown has been recognized as one of the region's most vital retail centers for a community of its size. Salem has retained its vital core and continues to be supported by strong and vibrant historic neighborhoods, the campus-like Capitol Mall, Salem Regional Hospital, and Willamette University. Salem offers a wide array of restaurants, hotels, and tourist attractions, ranging from historic sites and museums to events that appeal to a wide variety of interests. 1,869 acres of park land invite residents and visitors alike to enjoy the outdoors.

Course Participants

Dr. Robert Young, Assistant Professor, Planning, Public Policy and Management
Sharon Wade Ellis, Graduate Teaching Fellow

Orchard Village Group

Shannon Arms, Architecture Undergraduate
Jamie Corsaro, Architecture Graduate
Suni Dillard, Architecture Undergraduate
Michael Duncan, Planning, Public Policy and Management Undergraduate
Greg Eggers, Environmental Studies Undergraduate
Jackson Hite, Planning, Public Policy and Management and Environmental Studies Undergraduate
Sara Hoversten, Business Graduate
Brian Rajotte, Business Administration Graduate
Joan Russick, Architecture Graduate
Blake Scott, Architecture Graduate
Emma Silverman, Interior Architecture and Planning, Public Policy and Management Undergraduate

Glen Creek Group

Josh Havener, Community and Regional Planning Graduate
Lauren Houston, Environmental Studies Undergraduate
Gwynne Mhuireach, Architecture Graduate
Molly Simas, Environmental Studies Undergraduate
Maddy Stokes, Environmental Studies Undergraduate

SCI Directors and Staff

Robert Liberty, Executive Director
Nico Larco, SCI Associate Director, and Assistant Professor of Architecture
Marc Schlossberg, SCI Associate Director, and Associate Professor of Planning, Public Policy, and Management
Chris Jones, SCI Program Manager
Amy Hause, SCI Program Manager

Table of Contents

Acknowledgements	2
Executive Summary	6
Introduction	7
Glen Creek Village Sustainable Infill Development	9
Orchard Village Sustainable Development	12
Transportation: Islands in a Sea of Disconnect	13
Energy	26
Water	44
Agriculture	53
Materials	66
Resource Use and Social Interaction	72
Conclusion	75
Appendix: Case Studies	76
Additional Resources	81
References	82

This report represents original student work and recommendations prepared by students in the University of Oregon's Sustainable City Year program for the City of Salem, the Urban Renewal Agency of the City of Salem, or the Salem Housing Authority. Text and images contained in this report may not be used without permission from the University of Oregon.

Executive Summary

As one of the Sustainable City Year (SCY) projects this year, Green Cities students were asked to research, plan, and design environmentally friendly re-use and redevelopment options for the Salem Housing Authority (SHA). The Green Cities proposal approached development in Salem by organizing research into two teams, one focusing on the Glen Creek housing development site and one on the vacant Orchard Village housing site.

Students working on the Glen Creek site examined agricultural land use options, energy savings, improved connectedness with surrounding areas, and options for increased density. Students working on the Orchard Village site proposal incorporated sustainable development elements into their proposal to optimize site, energy, water, and environmental use for future growth. Additionally, each site was analyzed for potential development in relation to transportation, sustenance, and waste needs.

Research was conducted using site visits, in-class discussions, meetings with SHA representatives, and primary and secondary research.

Green Cities students suggested proposals, strategies, and technologies to create sustainable communities on both SHA sites, and to provide a cutting-edge template for future Salem development plans.

The following report focuses on general recommendations for the above-mentioned Salem sites. We suggest the City of Salem use these recommendations to inform construction and renovation at both Orchard Village and Glen Creek. However, if the recommendations are to be implemented into future plans, additional, site-specific studies will need to be undertaken to ensure that they are viable, efficient, and cost-effective solutions. Findings from this report will be passed on to and further developed in a two-term architecture studio taught by Professor Peter Keyes.

Introduction

The green cities concept is one that has evolved over hundreds of years. Beginning with our earliest ancestors, people have developed living methods and styles that harmonize with their surrounding environment. Over this brief history, humans have extracted and used natural resources as pragmatically as their technology, religious beliefs, and consumption habits have dictated. Many civilizations developed sustainable harvesting methods for natural resources and thus enjoyed a fruitful and efficient lifestyle. Conversely, a lack of harmonious ecological existence has resulted in civilizations overextending themselves and no longer having access to the resources needed to sustain their lifestyles. The 21st century has accelerated the issues surrounding resource scarcity. The rate of consumption has escalated as a result of modern industrialization; this rapid increase in an unbalanced approach to natural resource consumption has resulted in a multitude of environmental and social degradations.

The green city is an evolving concept that aims to reverse this trend and redirect it towards a more cohesive, balanced, and harmonious existence. The goal of the green city is to embrace natural landscapes into urban design, increase quality of life, and move toward ecological sustainability. The concept strives for social equality, environmental regeneration, and production of a more harmonious working relationship between modern urban infrastructure and natural ecological landscapes.

Salem Housing Authority

The mission of the Salem Housing Authority (SHA) is “To see that all low-income people in the Salem-Keizer community have the opportunity to live in decent, affordable housing and to move up and out of poverty.” SHA is committed to providing safe, decent, and affordable housing to individuals and families in Salem and Keizer, Oregon, who face income or other barriers to a better quality of life. SHA offers housing support through a variety of programs and services. It strives to educate citizens about the core services offered and to share how SHA is working with other organizations to build a stronger community. The SHA low-income housing policies, set by HUD, restrict rental eligibility to individuals or families that earn less than 80% of the median income, or for very-low-income, less than 50% of the median (SHA).

The fall 2010 Green Cities class at the University of Oregon had the opportunity to participate in implementing these ideals and applying them to the modern world through the SCY program. The Orchard Village and Glen Creek project sites gave students a tangible opportunity to implement a modern version of the green city teachings of Ebenezer Howard and Frederick Law Olmsted. The platform of an affordable housing development allows for the designing of a living community that promotes social and ecological harmony.

The SHA vision is one of sustainability. Rich in opportunities and welcoming innovation, SHA's housing could lead the way as Salem invests in that vision. The suggestions presented in this document will help promote Orchard Village and Glen Creek as progressive affordable housing solutions. Glen Creek and Orchard Village have been analyzed for their potential to increase the level of sustainability and responsibility to the entire Salem community.

The following sections will outline recommendations for optimizing energy performance, improving transportation options, implementing strategies for smart water use, promoting health and food security, recycling, landscaping, and promoting a deeper sense of community.

Organization

In order to direct the idea and information flow into a pragmatic and applicable structure, each area of focus is broken down into three types of recommendations based on feasibility:

Pivotal: These plans suggest modest improvements over the current standard of living in Salem. These recommendations assume materials and processes meet necessary current social and environmental standards. Pivotal strategies are the most basic and necessary suggestions offered toward a Green Cities vision.

Progressive: These plans suggest an improvement and elaboration of current precedents in sustainable development practices and social community development. These suggestions are forward-thinking, yet often are affordable with little up-front cost.

Pioneering: These plans suggest the most forward-thinking of sustainable development proposals. They explore the most idealistic and ambitious environmental and social design features. Although these suggestions typically lead to higher up-front costs, the long-term savings are often significant. Additionally, implementing pioneering strategies often provides opportunities for media exposure that will ultimately benefit the SHA and its residents.

The suggestions in this report exist in the "big ideas" realm. Although the research team champions the elements found in the Pioneering recommendations, we understand the financial, social, and administrative constraints that may arise. We suggest future groups extract and further investigate the components most suitable for achieving the desired success defined by Glen Creek, Orchard Village, and the City of Salem.

Glen Creek Village Sustainable Infill Development

Existing Conditions

Site Description

Built in 1978, Glen Creek Village Apartment Complex is a small, low-income residential development west of the Willamette River in Salem, Oregon. The apartments are on 7.78 acres in an agricultural-residential zone on the south side of Orchard Heights Road, surrounded primarily by single-family residential parcels (see Figure 1). There are 30 units in seven buildings with an additional building housing the rental office and community center. Twenty-two of the units have three bedrooms and one bathroom (872 sq. ft. in size), six of the units have four bedrooms and 1.5 bathrooms (1118 sq. ft. in size), and two units have five bedrooms and two bathrooms (1271 sq. ft. in size) (SHA).

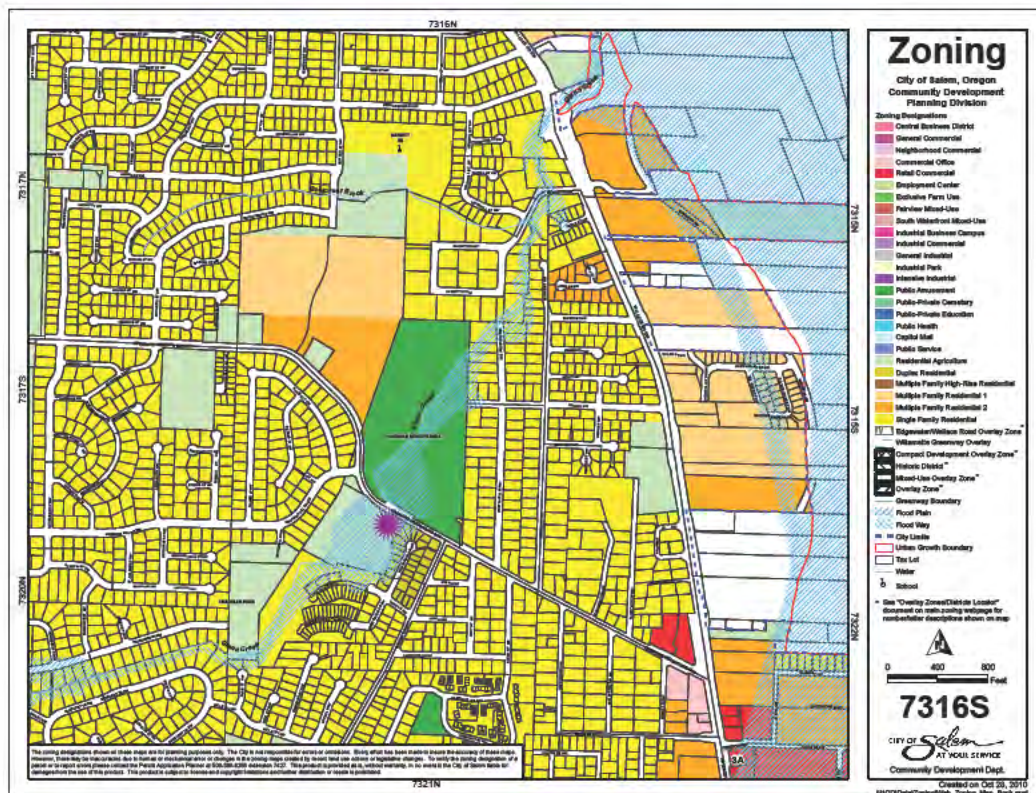

Figure 1: Zoning map. Glen Creek property indicated with purple star.

Located along Orchard Heights Road, a major arterial on Salem's west side, Glen Creek is surrounded by high value housing developments to the east and west, and parks on the north and south. The major transit routes for the development include Orchard Heights Road (on the north side of the development), Wallace Road (0.6 miles to the east), and Doaks Ferry Road (1.0 miles to the west). Of these roads, only Wallace Road provides access to regional shopping centers and Salem's downtown district (see Figure 2).

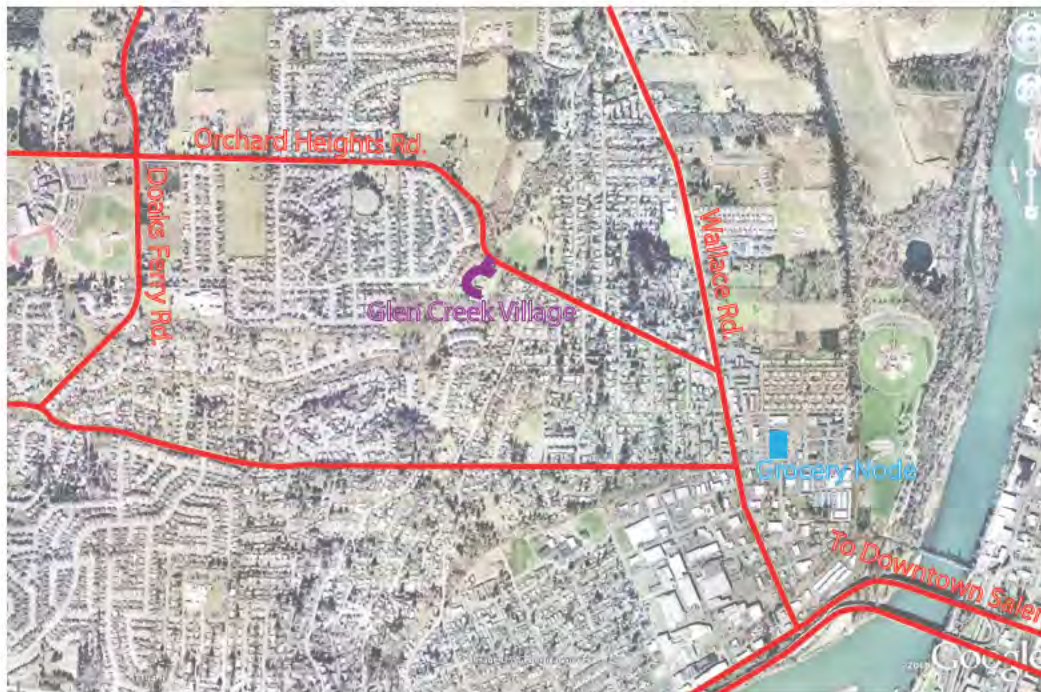

Figure 2: Glen Creek Village vicinity, aerial photo.

Constructing Additional Buildings

There is a possibility of constructing an additional residential building on the site, perhaps financed through bonding, grants, and incentive programs. The building could be designed for net zero energy use, using innovative low-cost building techniques and building-integrated energy production. The likeliest placement of this new building is along the western edge of the site.

Agricultural History

Glen Creek is located west of the Willamette River, in the Polk County portion of Salem, which was formerly and legally known as West Salem (many residents still refer to the area as West Salem). While the entire Willamette Valley has had historically fertile soils, the areas in West Salem were used to extract timber and harvest such crops as strawberries, loganberries, filberts, cherries, marionberries, hops, and wheat.

Demographics

The core demographic profile of the development, based primarily on Census Tract 52.02, with some data narrowed down from Block Group 3 and from SHA requirements, shows that the residents of the development are predominantly white (over 90%), low-income, and mostly work outside of Polk County (Census 2000).

In this census tract, there are 623 residents who fall below the 1999 poverty level. Residents of this area have a median age of 37, most have finished high school or a bachelor's degree, and most work in the fields of public administration, education, construction, or finance. The average house in this Census Tract was built between 1970 and 1989.

Orchard Village Sustainable Development

Existing Conditions

Site Description

The Orchard Village Complex was a small, low-income residential development in northeast Salem. Located between Broadway St NE and Salem Parkway (Highway 99E), access to the site is a narrow driveway off Broadway. Currently Orchard Village is a cleared site, but in the past there were 30 housing units. Those units were taken down because of poor unit layout and environmental concerns. Figure 3 below depicts the site with the former units in place.



Figure 3: Orchard Village site map (photo taken before all housing units were demolished).

Transportation: Islands in a Sea of Disconnect

Glen Creek

Transportation for many Glen Creek residents is a challenge. With limited access to personal automobiles and public transit options, residents are forced to either rely on those few who have personal automobiles, plan their trips around the limited public transit system, call for taxicab service, bike, or walk.

Transportation sources account for 70% of our nation's oil consumption and 30% of total U.S. greenhouse gas emissions.

According to the 2000 US Census (SF3), the 933 residents of Block Group 3 in Census Tract 52.02 (which includes Glen Creek) typically relied on private automobile as transportation to work (824), with the majority driving alone (683). Of the total residents in the Block Group, only 18 claimed to take public transportation, of which 12 used the bus service and 6 relied on ferryboat (US Census Bureau).

Active transportation (bicycle and pedestrian) accessibility is a major concern for the residents of Glen Creek. According to walkscore.com, the development

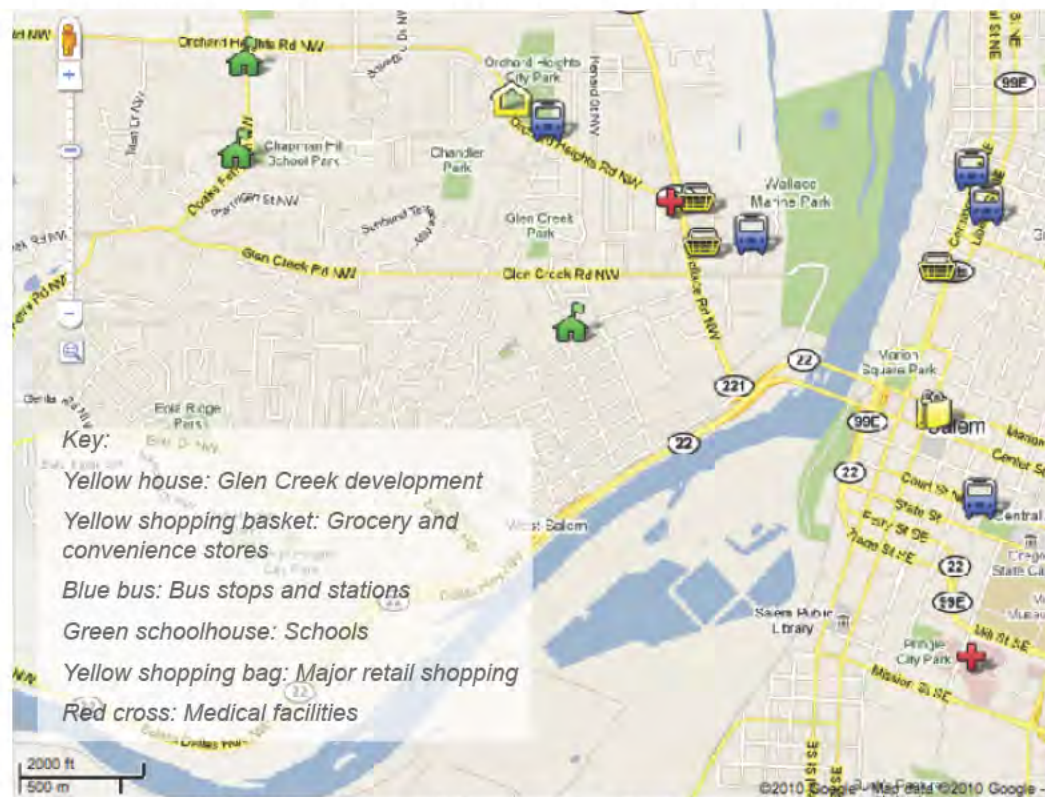

Figure 4: Glen Creek area, with transit stops, schools, shopping, and other destinations.

has a walkability score of 35/100 (Walkscore.com 2010). A score in this range is categorized as being car-dependent (Walkscore.com-how it works 2010).

The purpose of this assessment is not to recommend that every resident of the development have access to a private automobile. Rather, it illustrates the issues that those without access to private automobiles face on a recurring basis, especially those who are economically disadvantaged. Figure 4 shows a rough access map of the site and some of the more prominent areas and features in close proximity to Glen Creek.

Orchard Village

To make sense of the transportation challenges and opportunities at work at the Orchard Village site, it is necessary to understand the implications of the greater transportation environment surrounding the community. Orchard Village is cut off on all sides by major roadways with little or no connectivity. Those attempting to walk, bike, or bus, have little safe infrastructure to support travel.

We ran the following three analyses to determine the level of connectivity surrounding Orchard Village.

Intersection Density Map

The intersection density map (see Figure 5) is based on the premise that areas of greater connectivity will inherently contain a higher density of intersections. The grid-like nature of a typical downtown street system exemplifies this principle. This can be seen in the existing density surrounding Orchard Village.

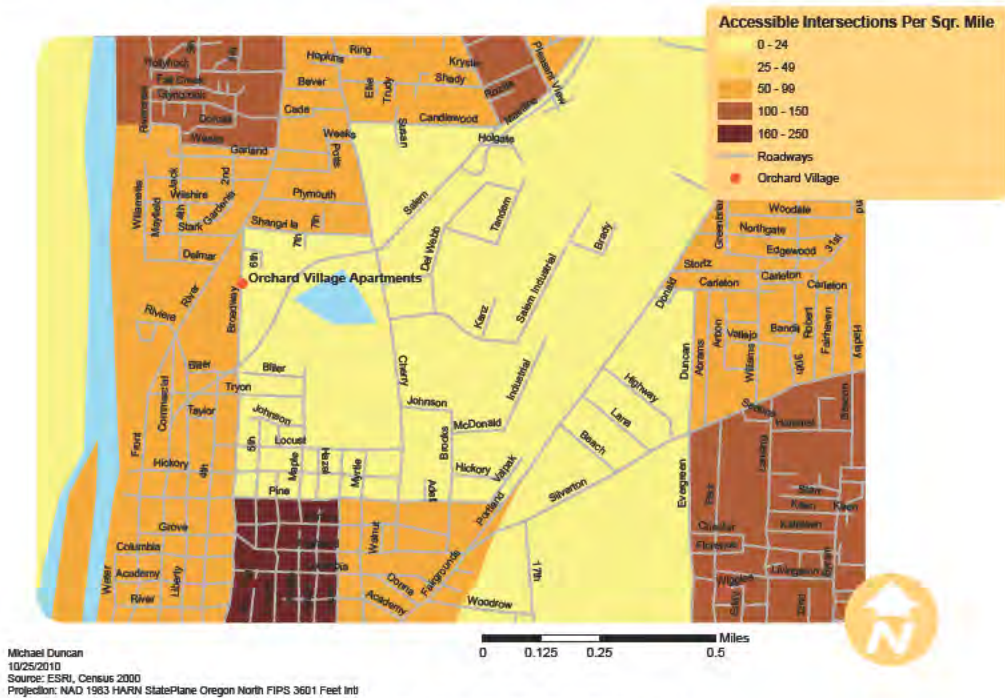

Figure 5: Density of accessible intersections near Orchard Village.

There are areas of high or moderate connectivity to the north and south, but the street network encompassing Orchard Village has a very low intersection density. Low intersection density creates connectivity challenges for cyclists and pedestrians, who rely on traffic signals for safe and protected street crossings.

Determining the Pedestrian Catchment Area and Impeded Pedestrian Catchment Area

A series of Network Connection Analyses were used to determine both Pedestrian Catchment Area (PCA) and Impeded Pedestrian Catchment Area (IPCA). A pedestrian asked to walk one-half mile in any direction through an open field would do so unimpeded. Any resulting route would manifest as a radius of a circle. That circle represents the true unimpeded area of travel. The PCA is the area any combination of routes traveled in a desired distance, in this case one-half mile, would produce. Quite often due to a lack of connectivity, the resulting area is much less than the ideal area of a circle. The ratio between this area and that of the circle is called a PCA ratio. A more

A 5% increase in the walkability of a neighborhood is associated with a per capita 32.1% increase in active travel, 6.5% fewer miles driven, 5.6% fewer grams of NO_x emitted, and 5.5% fewer grams of volatile organic compounds (VOCs) emitted.

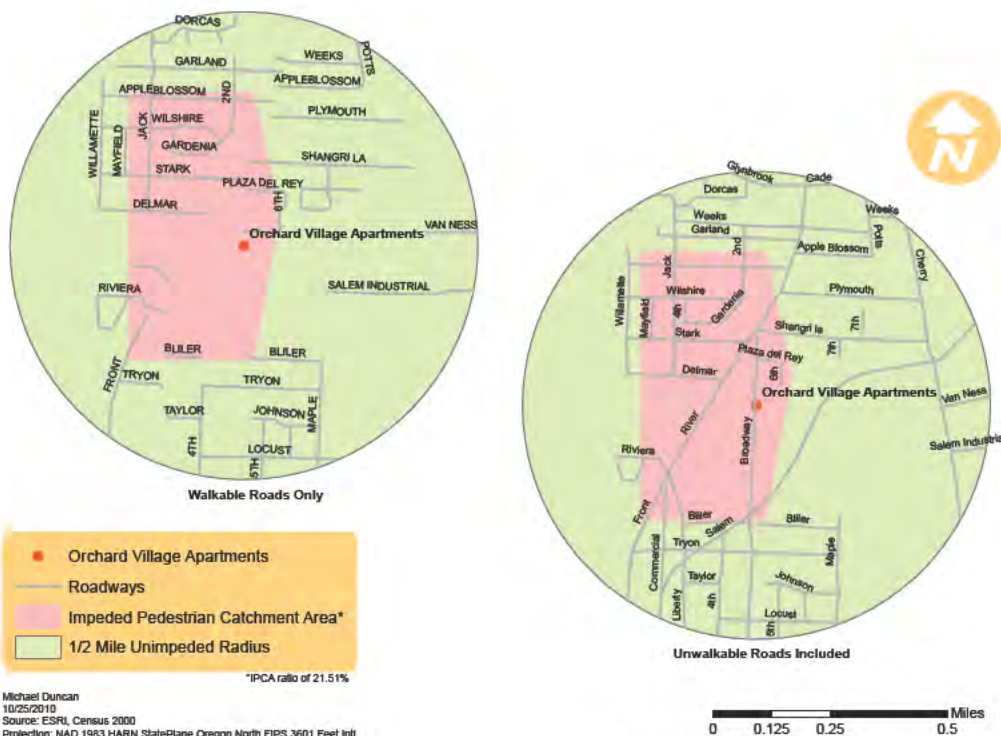

Figure 6: Walkability of Orchard Village.

accurate assessment can be given by the IPCA. The IPCA resembles the PCA, but in an attempt to depict the real world choices a pedestrian is confronted with, the multi-lane/unsafe roadways and their crossings are removed. An IPCA ratio of 0.5 is considered adequate; Orchard Village's IPCA ratio is low, 0.21 (Frank 2006).

Mapping the Transportation Choices of Communities Surrounding Orchard Village

Using Census Data, plotted by the Block Group, the mode of travel for workers over the age of 16 is represented as a percentage of the total overall workers commuting. While single-user vehicles represent the majority, there is a marked increase in pedestrian, bike and public transportation in the Block Groups north and south of Orchard Village. These clusters of active modes of transport provide insight to the opportunities available for Orchard Village if connectivity is improved.

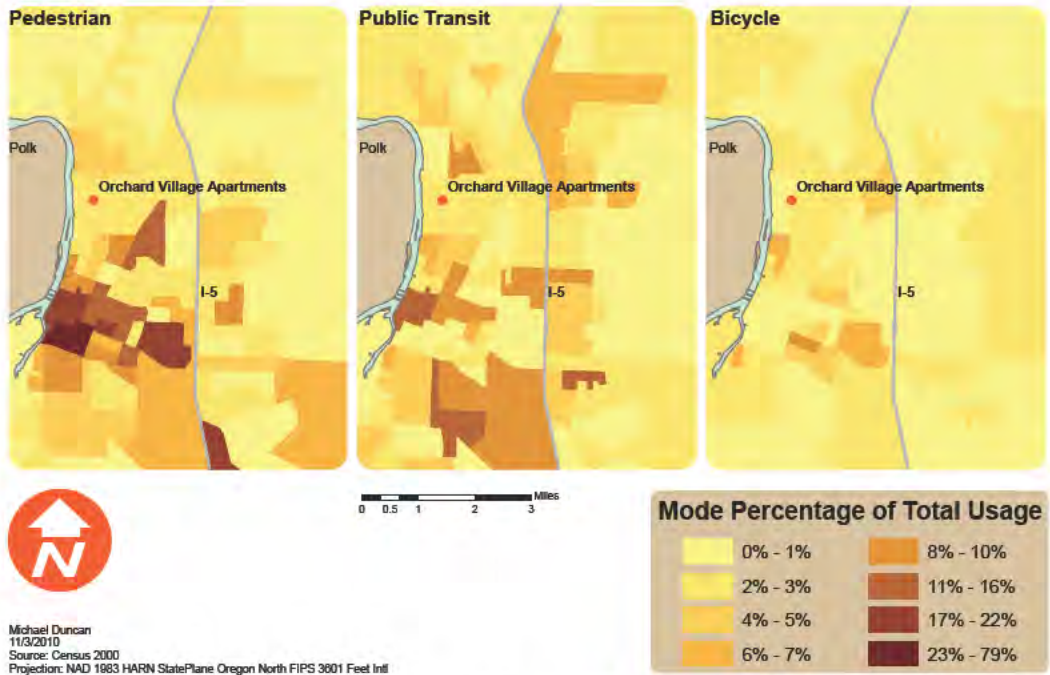

Figure 7: Bicycle, pedestrian, and public transit usage of urban Marion County.

Assessment of Both Sites

Salem-Keizer Cherriots Bus System

In the 2002 Willamette River Crossing Capacity Study, part of the Salem-Keizer Area Transportation Study, only two percent of the total population used the Cherriots System, while 84 percent used single occupancy vehicles, and 14 percent used other modes of transportation (carpools, taxicabs, biking, and walking) (Salem-Keizer Area Transportation Study). The public bus transportation system is not as robust in Salem as it is in other Oregon cities like Portland and Eugene.

The Cherriots system has three classifications of bus routes: frequent (primary), peak hour (secondary), and standard (tertiary); all routes only run Monday through Friday. For the residents of the Glen Creek development, the only bus line that provides service in the area is the #10 bus, a tertiary route (Cherriots website 2010).

In addition to being on a tertiary route, there are limited numbers of pick-up stops for residents, which becomes the main problem for the Orchard Village development. Although residents of Orchard Village would have the option to ride a few different buses, #9 and #19, the stops along these routes are difficult to access because of Broadway Avenue, a large thoroughfare. Unlike bus systems in Portland and Eugene, the Cherriots system typically picks up riders at primary stops; however, it will drop residents off at any secondary stop along the way. This raises many concerns for potential riders, as they must travel roughly a half-mile just to get to a bus stop that will pick them up (Cherriots Website 2010).

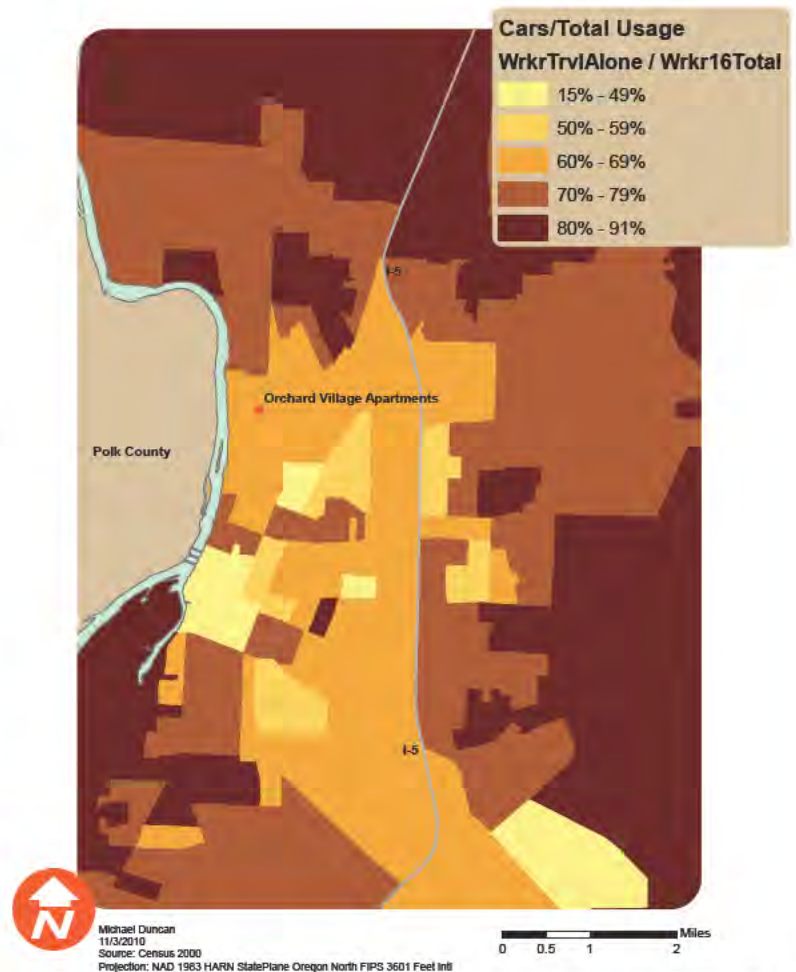

Figure 8: Percentage of urban Marion County workers who commute in single-occupancy vehicles.

Cost

The fares for the Cherriots system can be burdensome for those who have a low or fixed income. Currently, Cherriots charges adults \$1.50 for each segment of a bus trip, \$3.35 for a day pass, \$40 for a monthly pass, and \$480 for an annual pass. Youth and “special” rates are less expensive.

Glen Creek and the Salem-Keizer School District Busing

The Salem-Keizer School District will not provide bus service to the Glen Creek development. The nearest schools to the development are West Salem High School (1.0 miles away), Walker Middle School (1.3 miles away), and Chapman Hill Elementary (1.25 miles away). (Data based on road network distances from the development’s driveway to the school driveway.)

The Salem-Keizer School District’s current policy states that any high school or middle school student who lives within a 1.5-mile radius of the school must walk, and 1-mile radius for elementary school students. The School District does not define their measurement methodology; however, Chapman Hill Elementary School falls outside of the 1-mile radius. This means that children as young as five years old must walk over a mile to school if their parents cannot drive them. Many times, students do not make it to school on time, as the SHA has labeled truancy as a major concern in the Glen Creek development.

Walking and Cycling

Walking and cycling are two viable alternatives for some residents, even though there are some drawbacks to these methods of transportation. Due to the topography of the Glen Creek development and the surrounding area, there are many winding and hilly roads that must be traversed in order to reach any destination. These conditions are not always safe for the residents, as the sidewalks and bike lanes are poorly maintained. Additionally, Orchard Heights Road is a major arterial thoroughfare, with higher speed limits than a residential street. Orchard Village faces similar constraints, with large thoroughfares, Broadway Avenue and River Road, as the only adjacent roads for residents to walk or cycle along. Compounding all of this is the long travel distances and times to reach even the most basic services, such as grocery stores, medical facilities, schools, retail locations, and employment centers.

Access to Basic Services

Residents of both housing developments are limited in their options for basic services if they do not own an automobile. Furthermore, shopping via active transportation can be difficult when considering the challenge of carrying home purchased goods and traversing multiple lanes of vehicular traffic.

The nearest grocery store to Glen Creek, Roth’s, is located roughly 0.8 miles away from the development. The nearest grocery store to the Orchard Village site, Fred Meyer, is located roughly 0.4 miles away. While these are within

walking distance for the able-bodied individual, those with young children, and the elderly and disabled, face a significantly greater accessibility challenge.

For Glen Creek, the nearest doctor's office is located near the intersection of Orchard Heights Road and Wallace Road, which is roughly 0.6 miles from the development. If the resident were to need emergency medical attention (without the need for ambulance), the nearest hospital is located 2.6 miles away across the river. (This data for Orchard Village was not calculated.)

Parks

Glen Creek is close to two parks that border the development to the north and the south, but in order for residents to take advantage of these parks, they must cross either Orchard Heights Road to the north or Glen Creek to the south, both of which present different challenges. In order for residents to access Orchard Heights Park, they must walk along and cross Orchard Heights Road. Due to the layout of the road and the topography of the area, visibility can be limited. If residents wish to visit Chandler Park, they must cross Glen Creek. While the creek itself is not wide or deep, it may be an obstacle for some.

Orchard Village has an opportunity not only to connect to nearby parks but to the Kroc Center as well (only 1.6 miles away, a 30 minute walk). In order for these places to be reached, a resident has to cross or walk along Broadway Avenue, Salem Parkway, or River Road, all of which have multiples lanes of traffic and infrequent crossings.

World Class Transportation Resources: Recommendations for SHA

There are many strategies that can be implemented to help mitigate connectivity and accessibility issues facing Glen Creek and Orchard Village. By beginning with the Pivotal strategies and continuing into the world of Progressive and Pioneering, Glen Creek and Orchard Village can translate these challenges into opportunities. We recommend adopting a strategy to overcome these limitations and encourage residents who are otherwise apprehensive about alternative transportation to make that first step; in doing so, residents can save money, help the environment, and become part of an active, healthy, and livable community.

Glen Creek

Walking

In order to aid in connectivity between neighboring park spaces and the Glen Creek development, we recommend that SHA, Salem Parks, Public Works, and the Oregon Department of Transportation consider the erection of elevated or excavated pathways that would connect the development to parks.

If this is not a viable solution, then we suggest installing signage and lighting at crosswalks to increase the visibility of pedestrians trying to cross between the development and the park. Additionally, we recommend footbridges be erected over Glen Creek between the development and Chapman Hill Park to allow for better access.

Cycling

The Glen Creek area needs improved infrastructure for cyclists, including signage and segregated cycling lanes. The cities of Salem and Keizer have published bicycle route maps on their website. Despite having dedicated cycling lanes on some streets such as Orchard Heights Road near the Glen Creek development, the City of Salem has adopted a new type of marking for many of its roads where additional rights-of-way or lanes are not possible.

In an effort to increase the accessibility of the development for bicyclists, the SHA could work with the Oregon Department of Transportation and Salem Public Works to increase the number of dedicated bike lanes in the West Salem area by repainting existing bike lanes, and improving the bike lane signage.

Glen Creek Parking Lot Redesign

Since many of the current parking spaces are unused, parking could be consolidated in an effort to maximize green space and remove unneeded impervious surfaces from the site. Additionally, this would allow for a redesign of the entrance to the development.

The recommended redesign would move the driveway from the west side of the development to the east side, providing two main benefits to residents. First, it would add 0.1 miles of road distance to the measurements for school bus routes, potentially enough distance to convince the Salem-Keizer School District to bus students to their respective schools. Second, the recommended redesign would improve the visibility of residents who are crossing the street, and also those who are turning into and out of the development in vehicles.

We recommend negotiations with the Salem-Keizer School District prior to any renovations. Additionally, we suggest SHA conduct a cost-benefit analysis before any costly redevelopment takes place.

Salem-Keizer School District

We recommend SHA open a dialogue with the Salem-Keizer school district. This dialogue should clearly establish the measurement technique employed by the School District when determining the distance from a development to the schools for busing purposes. Should the School District hold their position that the student residents of Glen Creek must continue to walk to school, we suggest SHA investigate the feasibility of creating a community shuttle that students could use in order to travel back and forth to school.

Orchard Village

Cycling

Unlike Glen Creek, Orchard Village is in an area already invested in separated cycling infrastructure, although the area needs improvement. Neighborhoods directly north and south of Orchard Village are connected with cycling lanes that are being re-stripped and re-painted.

Orchard Village is located centrally between Keizer and downtown Salem. On the ground bike symbols exist, indicating intended usage for both motorists and cyclists. Particular attention is paid to the intersection of Salem Parkway and Broadway, as well as the Broadway/River Road intersection, where the cycling lane is painted a solid lime-green as a visual cue to motorists. Currently, the cycling lane is faded and stops just before both intersections. These intersections contributed heavily to the low IPCA ratio.

The Intersection Density and IPCA maps (see Figures 5 and 6) indicate the need for a safer, appropriately connected community. The first step to that connectivity is giving Orchard Village a bike and pedestrian specific crossing. We recommend a location just south of the Orchard Village entrance. Flashing caution signs and a strip of user-activated flashing LED ground lights could denote the crossing. Crossing four busy lanes of traffic can be a challenge for children, elderly, and alter-abled pedestrians. To accommodate such varied usage, we recommend a traffic-calming island provided mid-way.

Both Sites

Separated Cycling Lanes

We recommend separation of cycling lanes from autos by a raised curb, and, space permitting, a planted barrier. Separated cycling lanes help cyclists who are interested in cycling but who are hesitant to become active riders due to perceived safety concerns of mixed-use roadways. Additionally, separated cycling lanes would serve as a supplemental buffer for pedestrian safety.

Bicycle Racks

We recommend installing, at a minimum, 25 inverted U style bike racks on the property. We recommend providing long-term, well-lit bike parking that is enclosed by a gate and covered. This protects the bikes from the elements and reduces theft. Additionally, we recommend installing 10 short-term bike racks

After buffered bike lanes were installed on Philadelphia's Spruce and Pine streets, bike traffic increased 95% and the number of bicyclists riding on the sidewalks decreased by up to 75%.

for visitors or short trips, also covered, but unenclosed. For reference, one car parking space can be repurposed to accommodate 6 racks, or 12 bicycles. Racks will follow additional guidelines as per ODOT standards.

Cycling/Pedestrian Network Map Placard

We recommend a placard depicting close and easy bike and pedestrian pathways near bike racks and main pathways to inform residents and visitors of safe and efficient travel routes, including estimated travel time.

Transportation Options Move-In Info Pack

In order to foster community awareness and support for alternative transportation, we recommend providing a “Transportation Info Pack” to residents upon moving into the developments. This could potentially be extended to all SHA housing. Among many ideas, we suggest including: cycling/pedestrian city maps, public transit schedules, bike bells and lights, reflective pant-cuff bands for walkers/joggers/cyclists, and a bus pass. Additionally, we suggest permanently securing a bike/pedestrian map to the inside of the pantry door of each housing unit.

Bike Facilities

To assist residents in bike maintenance and ensure bike riding health and safety, we recommend bike facilities composed of a water-bottle-friendly drinking fountain, an air station for tires, and a permanent bike stand for repair work (e.g. tire changes, brake adjustment, cleaning). We suggest making tools available for checkout at the main office.

Bicycle Maintenance and Safety Classes

Partnering with local advocacy groups, Glen Creek and Orchard Village could host monthly or quarterly bike maintenance classes and successive bike safety classes. Bike maintenance would focus on items that are easy for individuals to learn, while bike safety classes would educate riders on local laws and proper bike etiquette. The safety class could also address an overall goal of familiarizing new riders, and building confident and empowered cyclists. Not only would classes serve as an educational tool, but also as a community building opportunity, where participants could encourage and support each other with bike and other active transportation choices. Ideally, these classes would serve the greater community of interested cyclists.

Local Cycling Shop Partnership

Partnering with a local bike shop, residents of both Glen Creek and Orchard Village could be the recipients of promotional deals such bike locks or helmets. The cycling shop could provide goods for marketing opportunities derived from sponsoring SHA properties. This could take the form of website accreditation and advertising with co-sponsorship (e.g literature, leaflets, media).

Cycling, Pedestrian, and Bus Use Incentives

Where parking spaces are assigned to each unit, active transportation incentive programs have been successful. For example, any unit not using their parking

space could potentially be eligible for a rent discount of \$20 per month. This incentive is meant to encourage the use of alternate modes of transportation (Dunn 1999). Additionally, free or reduced bus fare could be used in conjunction with the rent incentive.

Small Scale Bicycle Share

This program provides residents access to a card-lock based system which allows individuals to check out bicycles and use them for recreation, errands, school, or commuting. Without the financial commitment of owning a bicycle, this system is ideal for introducing community members to the freedom and fun of riding. There may be an opportunity to expand this service to additional housing projects and neighboring residents as the program grows.

Bike Rebuild Program

A (re)Build-a-Bike program takes donated bikes, strips them of no longer useful or broken components, and rebuilds them into functional and fun transportation. This program would ideally work closely with the bike maintenance classes and be open to any resident, though the focus would most likely be on youth, providing a basic understanding of the skills required to be a bike mechanic.

Cherriots Bus Improvement

Negotiation with the Cherriots bus system for expansion of hours, routes, and stops would be beneficial to residents of Glen Creek and Orchard Village. This recommendation is in line with the existing Salem-Keizer Area Transportation Study's recommendations to increase transit service on existing routes (shorter headways), restructure current transit service (creating a time-transfer station), add transit routes, and add express bus services that would be coordinated with park-and-ride lots (which could potentially benefit automobile owning residents of Glen Creek and Orchard Village) (Salem-Keizer Area Transportation Study). Since residents of all SHA developments have low incomes, reduced fares on all Cherriots buses, would improve residents' access to public transit.

Finally, the erection of bus shelters would not only benefit the residents of Glen Creek and Orchard Village, but all residents of Salem-Keizer who take the Cherriots system. Any new bus stop should be covered, well lit, and complete with wayfinding placard.

Parking

At a ratio of 1.2 parking spots per unit, we recommend parking be located along the perimeter of the property, away from children and pedestrian activity. These assigned places are well lit, uncovered, and reverse diagonal. Introducing this unique parking configuration affords greater safety and lower crime. With increased visibility, drivers can navigate better when pulling out of spots. Nefarious activity is curtailed when parking spaces are in direct view of the road.

It costs three to four times more to enroll a sedentary adult in a structured exercise program than to teach them how to integrate moderate-intensity physical activity into their life.

Shuttle/Dial-A-Ride Service

We recommend examining the creation of a Dial-A-Ride service for all SHA properties. The creation of this type of service would allow residents to phone into a “dispatch” to arrange rides within the city. While it is likely that this type of service would be moderately expensive on the front end of the implementation, it is possible that a portion of the operating cost could be added to individuals’ rent. There are many communities across the country that have adopted this type of service for those who are elderly or disabled, including Salem’s Cherry Lift service (see Figure 9).



Figure 9: Cherriots Cherry Lift shuttle.

Zipcar

Zipcar, a nationwide car share program, would provide Salem residents access to an on-demand network of automobiles. Individuals who wish to use this type of service sign up through the Zipcar website that allows a member certain access levels to the global Zipcar fleet. Zipcar plans start at a rate of \$60/year. All Zipcar plans charge an hourly/daily rate (starting at \$7/\$69 respectively, based on the type of vehicle requested) for automobile usage, as well as a free daily mileage rate (with additional miles costing more). Monthly contract plans are available for those who would use the service more frequently.

If implemented, this service could potentially prove to be far less expensive than individual automobile ownership, as the Zipcar service includes automobile insurance, maintenance costs, and gasoline for the cars, which would alleviate many cost burdens for residents in SHA developments (Zipcar.com 2010).



Figure 10: Zipcar vehicle.

These types of programs have already seen success in urban centers such as Portland, Oregon; Seattle, Washington; and Vancouver, British Columbia.

Proposal

Pivotal: Installation of cycling lanes, and literature provided to residents upon move-in for the promotion and support of alternative transportation. Further communication with the school district on busing options for children at Glen Creek.

Progressive: Negotiating with Cherriots for increased service and decreased fares, establishing a dial-a-ride program, improving bike infrastructure, and redesign of Glen Creek parking lot.

Pioneering: Site specific cycling and pedestrian crossings, infrastructure to connect the sites to nearby parks and other necessary destinations, bike share programs, and the implementation of Zipcar infrastructure.

Energy

Energy Outlook

The Salem city website states that “The City is undertaking and supporting actions to improve local sustainability through a variety of initiatives, by partnering with state or local organizations, leading efforts in its own buildings, and providing conservation and pollution prevention programs.” This statement demonstrates Salem’s interest in becoming a pioneer in energy awareness and conservation. An emphasis on conservation can help make sustainability

Over half of the average residential energy costs go towards heating, cooling or lighting needs (Lawrence 2010).

a priority in the community and reduce costs to residents. Conservation of energy through efficiency upgrades and use reduction will benefit the individual residents, the SHA, and the global environment.

Reducing or eliminating the use of off-site non-renewable energy resources is crucial to the sustainability of all new and existing buildings for three main reasons.

- The current overwhelming reliance on fossil fuel combustion for electricity and on centralized distribution systems has a negative impact on the environment.
- Creating a certain level of energy independence for districts, neighborhoods, or communities increases the resilience of societal structures in the event of disaster or utility disruption.
- Residents will be able to achieve a higher degree of comfort in their homes while reducing their electricity bills. SHA will see a decrease in energy bills, allowing the program to allocate more funding toward reaching other goals.



Figure 11: Glen Creek housing.

Glen Creek Development

Organized as town homes within each building, each unit spans the width of the building, providing each apartment with exterior openings on at least two sides. If properly designed, this arrangement allows residents access to daylight and cross-ventilation for cooling. The buildings have various orientations ranging from approximately 20° east of south to one building facing almost directly due west.

The buildings use conventional 4-inch stud-wall construction. A state-mandated building

code addressing energy efficiency did not exist in 1978 when the buildings were constructed, so it is likely that the wall insulation is between R-7 and R-13. The original windows are probably single-pane wood-frame or aluminum-frame. SHA has been systematically upgrading windows and appliances between occupancies, installing double-pane vinyl windows and ENERGY STAR rated appliances.

Currently, the units are provided with:

- Range: Frigidaire model # FFEF3011LWA.
- Refrigerator: Frigidaire model # FRT18HB5DWC.
- Dishwasher: Frigidaire model # FFBD2403LWOB.
- Hot Water Heater: 50-gallon electric 4500 Watts.
- Heating: 5 ft. baseboard per bedroom, 1500 Watts each (3-5 per unit), 2 ft. baseboard in hallways, 750 Watts each (2-3 per unit), 8-10 ft. baseboard in living room, 2500 Watts, one Cadet heater in kitchen.
- Lighting: Standard fixture with two 60 Watt bulbs per bedroom (3-5 per unit) and in hallways (3-4 per unit), 4 ft. fluorescent lights in kitchen and dining room (2 per unit), 24-inch fluorescent light in kitchen (1 per unit), compact fluorescent 7 Watt outdoor light (1 per unit), standard outdoor fixture with one 60 Watt bulb (1 per unit).

Residents typically supply their own washer/dryer, microwave, and air conditioner. Only stand-alone air conditioners are permitted, as opposed to window-mounted. Most tenants use box fans for cooling in the summer (Utz 2010).

Strategies for Reducing Energy Footprint

Potential for Improvement

Energy Scheming 3.2 is a software program that allows visualization and analysis of building elements and configurations that affect energy use (Brown, Sekiguchi 2008). A simple model created with this software shows how one of the townhouse units of Glen Creek might gain and lose heat through its exterior (see Figures 12 and 13).

A south-facing (main entry facing south) three-bedroom unit located on the west end of the building was used for the model. A base case that approximates the current energy use of one of the units was modeled, and then various passive strategies were added to the model. Figure 14 is a graph comparing the thermal performance of the base case, each separate alteration, and then all of the passive strategies used simultaneously.

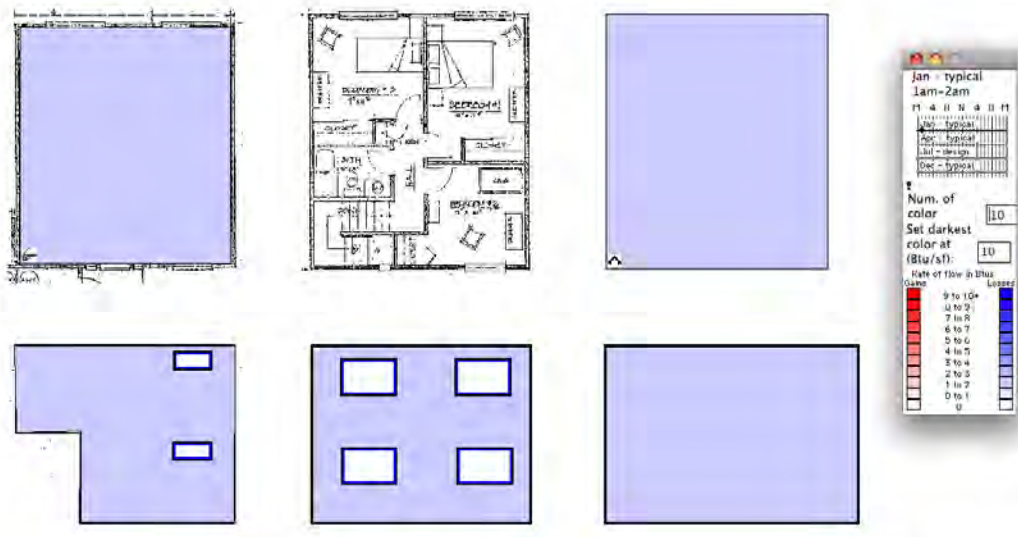

Figure 12: Modeling winter heat loss in a typical Glen Creek housing unit.

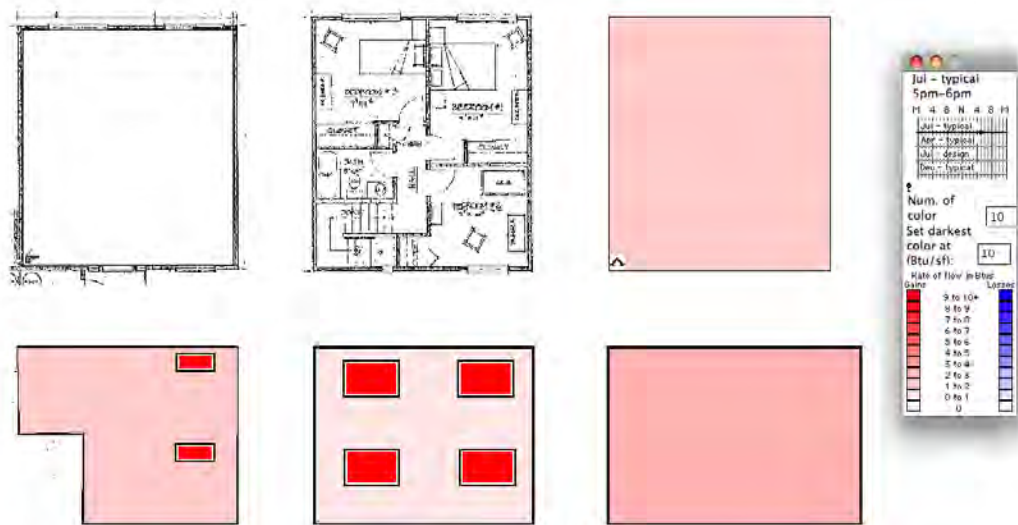

Figure 13: Modeling summer heat gain in a typical Glen Creek housing unit.

The strategies for this unit that had the best “bang for the buck” were reducing infiltration (significantly decreases winter heat loss) and using natural ventilation (lowers the summer cooling load). Other changes, such as adding exterior shading devices (fixed overhangs installed above the windows) did not have a significant effect in this model since the selected unit had only two small windows on the south side. However, these strategies could have much greater impact on a unit with more window area facing south or west. Modeling of this type can also be helpful with new construction to test ideas and ensure the most efficient design.

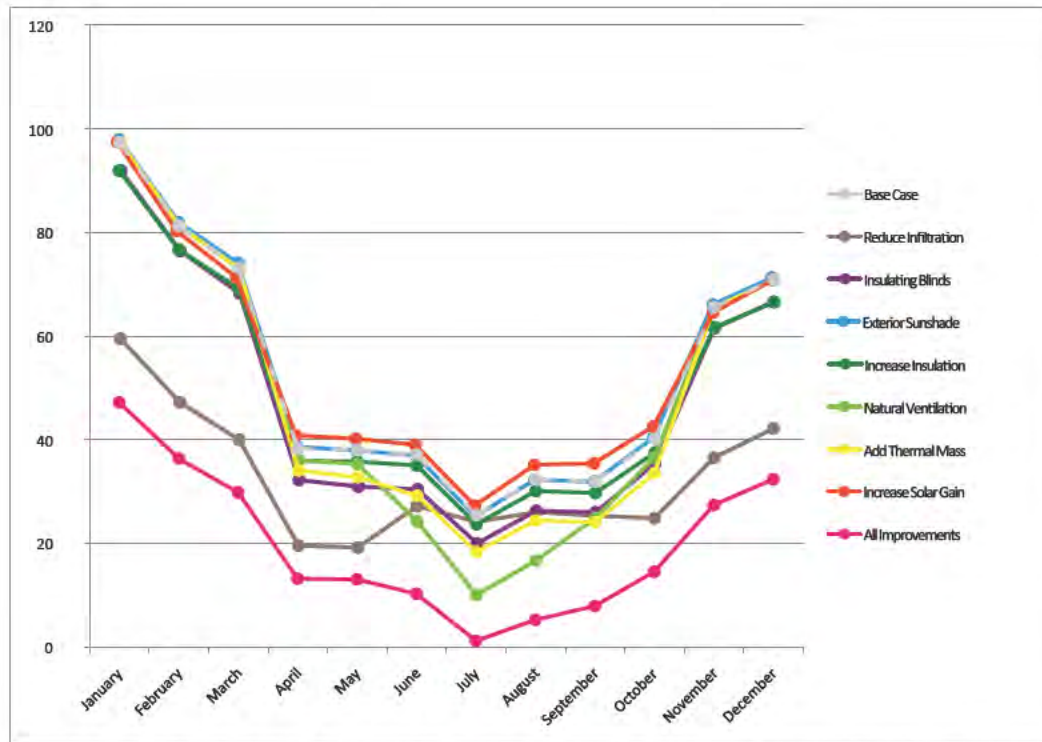

Figure 14: Thermal performance analysis showing effects of different proposed changes.

First Steps to Increase Energy Efficiency in Existing Buildings

The first steps to take in developing an appropriate program for increasing energy efficiency at Glen Creek include auditing current and historic energy use for all units and performing physical tests to determine infiltration and insulation characteristics of a typical unit. The energy audit would involve accessing past electricity, gas, oil, and propane bills and analyzing the data to discover the largest energy draws.

Several tests can determine infiltration and insulation values. The simplest, a blower door test (see Figure 15) can take less than an hour and determines the infiltration rate of the entire space in number of air changes per hour. A co-heating test would be more

Diagnostic Tools

Testing the airtightness of a home using a special fan called a blower door can help to ensure that air sealing work is effective. Often, energy efficiency incentive programs, such as the DOE/ EPA ENERGY STAR Program, require a blower door test (usually performed in less than an hour) to confirm the tightness of the house.

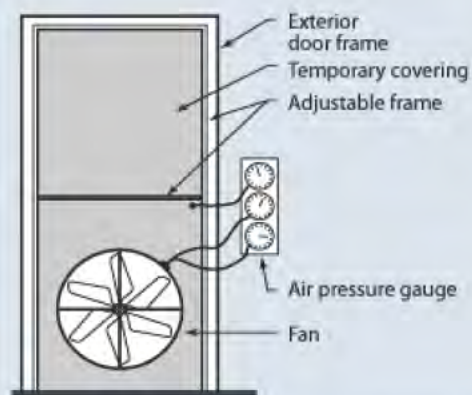

Figure 15: Blower door.

involved, but would also give a more complete picture of the unit's performance. This test is performed over a period of 12-24 hours in an unoccupied unit, and results in an accurate estimate of the whole-unit heat loss or gain characteristics.

With a good understanding of where and how buildings are using the most energy, SHA can prioritize replacement and upgrading to target those changes that will yield the highest results.

Use Reduction: Building Individual Awareness

Current Status of Glen Creek Apartments

While upgrades to the building and installation of energy efficiency appliances contribute to lowering electricity demand, human behavior also affects energy consumption. A common credo used by Professor G. Z. Brown of the Energy Studies in Buildings Laboratory at the University of Oregon is: buildings don't use energy, people do. Utility consumption data indicate a tremendous range of electricity use, even among similar residences and demographically similar occupants, that can be best attributed to behavioral differences (Lutzenhiser 1993).

The average energy usage per unit is 1261 kWh per month; the highest is 1646 kWh per month, and the lowest is 814 kWh per month. The range in energy usage could be attributed to a number of apartment characteristics, such as location within building, orientation, and window types, or it could be due to higher appliance efficiency or to different use patterns by the occupants. Further studies of these issues would be valuable.

Comparing the average of four years of electricity use at Glen Creek to the national average for buildings of the same type and occupancy (low-rise multi-family), 8 units use more energy, 21 units are within the national range, and only 1 unit used less energy.

Informational Feedback

A large part of the energy conservation effort will depend on the individual habits of the residents themselves. Therefore, the managers of Glen Creek and Orchard Village should strategically think about how to influence behavior by educating the residents on how and why they should conserve energy. In order to achieve maximum energy use reductions, the residents should join SHA in changing their use habits. Research shows that, after upgrading the building envelope and increasing the energy efficiency of appliances, feedback about energy consumption, especially when paired with information about neighbors' behavior (either positive or negative), is effective in reducing behavioral energy use (Geller 1983).

Visual feedback methods that occur in real time (see Figure 16) are found to be more effective than periodic text-based feedback, such as monthly bills, particularly when employed along with education and incentives (Petersen 2007). A simple way to provide education and incentives is to post semi-anonymous monthly energy use data for all the units along with a monthly tip for changing behaviors. We recommend posting this data in a high use area, such as near the complex mailboxes or in the proposed new laundry facility and delivering the same information electronically (for residents with email) via a monthly newsletter.



Figure 16: Monitor showing real-time feedback on household energy use.

Energy Company Programs

Many utility companies are engaging in programs to reduce residential energy use through “smart” metering, data-collecting outlets, and in-home visual displays. Often these programs receive government grants or incentives to assist in equipment purchase and installation (Friedrich 2010). Alternatively, researchers at colleges and universities may be interested in studying the effectiveness of these tools for reducing energy consumption, and may be able to secure grants to fund the efforts.

Another successful method used by utilities to reduce residential energy use is a pay-as-you-go program. The M-Power program, used in the Salt River Project, Arizona, installed ATM-like meters that accept credit or debit card payments and show remaining energy balance in dollars rather than in kWh. In order to offset the risk of service disconnections to those who might not have enough money to pay their bills, the utility waived their \$150 reconnection fee. In addition, overall energy use dropped by 12 percent on average, making consumers’ bills lower.

Building Upgrades

Expanding upon SHA’s current policy of upgrading windows and appliances, adding extra insulation to walls, attics, and crawlspaces (especially if applied in a fashion that eliminates thermal bridging through the wall studs), and reducing infiltration, could have a tremendous impact on heating and cooling loads, as well as on the comfort of the residents. Some of these alterations could be made while buildings are occupied.

Master Switches

SHA can help residents to reduce electricity consumption through behavioral changes by installing master switches within the units to allow powering down of all extraneous appliances and energy draws when occupants leave the unit or

go to sleep. Remote-controlled devices, appliance LEDs, and phone chargers are a few examples of “phantom loads” that continue to draw energy even when devices are not being actively used. According to Salem Electric, phantom loads represent up to 6 percent of electricity use in the United States. A relatively easy fix for this problem is the use of plug-strips for all appliances and electronics that can be powered down without harm to the device or interruption of its services. Desktop computers and refrigerators are examples of items that should not be controlled by a master switch.

New Construction: Potential for Net Zero Energy Use

SHA should seek designers willing to pursue a net zero energy building, or a building that produces as much energy as it uses. To achieve this level of energy performance, it is necessary both to maximize the efficiency of the building elements and to minimize the amount of energy used by the occupants. The new building could also target other sustainability goals, such as LEED Platinum or the Living Building Challenge, both of which incorporate many sustainability measures beyond energy use.

On-Site Energy Generation

Further sustainability can be achieved through use of renewable energy instead of fossil fuel based electricity sources. Renewable energies are defined as those that can be naturally replenished. This includes energy from sunlight, wind, water, and geothermal sources. The greatest advantage of renewable energy is that fuel cost can be free once the infrastructure is in place. Glen Creek and Orchard Village are ideal sites to use multiple forms of renewable

energy and have the potential to stand out as distinguished examples for future development.

Specifically for Glen Creek: of the eight existing buildings on site, four have roof slopes facing close to south (see Figure 17). If electricity-producing photovoltaic (PV) panels were installed on these roofs, a maximum of 300 kWh/day could be produced annually. On the other hand, utilizing the same area for solar thermal production to heat hot water could produce the equivalent of 931 - 1164 kWh/day annually (Brown, Decay 2001).

Other options for producing on-site power are micro-wind turbines, a combined heat and power (CHP) facility, or ground-source heat pumps. It



Figure 17: South-facing roof area (orange) at Glen Creek.

is important to consider the feasibility of all options within the context of climatic conditions, budget, site size, and the potential for larger district generation systems. When viewed under these lenses, some options will emerge as better sources for immediate implementation, while others may become options for consideration on other SHA sites.

On-Site Renewable Energy Generation Calculations:

Photovoltaic Panels: $41.3 \text{ Wh/ft}^2/\text{day} * 7250 \text{ ft}^2 / 1000 \text{ W/kW}$ (based on a 12% cell efficiency)

Solar Thermal Panels: $160 \text{ kBtu/ft}^2 * 0.293 \text{ kWh/kBtu} * 7250 \text{ ft}^2 / 365$

Optimizing Energy Performance

Appliances and Building Electronics

Appliances and electronics account for about 20 percent of energy use in an average home. Energy Star is a joint program of the U.S. Environmental Protection Agency and the U.S. Department of Energy that certifies energy-efficient products. We recommend that all appliances and electronics at both Glen Creek and Orchard Village be Energy Star certified. SHA should continue to replace older appliance models with higher efficiency models to help reduce appliance loads. Further reductions in energy use could be achieved by supplying residents with other high efficiency appliances, such as laundry machines (perhaps best achieved through the addition of a shared facility, or encouragement to use laundry lines), televisions, and vacuum cleaners. These types of residential appliances are frequently among the least energy efficient. SHA should also be aware of the types of lamps used in lighting fixtures. All lamps should be fluorescent to reduce energy costs.

For future construction, SHA should consider programmable thermostats. These thermostats can adjust the times that heating and air conditioning are active according to a preset schedule. This can potentially save up to 10 percent of heating and cooling costs if used correctly. Residents should be discouraged from heating or cooling their homes when their unit is not occupied. The type of heater used with programmable thermostats should be considered just as much as the decision to install them. Electric water heaters may be as energy efficient, and in some cases more so, than the solar water heating systems. However, they still rely on electricity. A primary system used is “demand” or “instantaneous” water heating. In this type of design, heating units are placed close to each individual water outlet. This eliminates the need for a storage tank and reduces the energy associated with keeping the water inside the tank warm (www.energysavers.gov 2010).

Fluorescent Lighting uses 25%–35% of the energy needed to produce the same amount of light as incandescent lighting.

Passive Building Systems

Passive systems strategically use architectural elements to harness natural energy sources for the purpose of heating and cooling spaces. This strategy uses natural energy resources rather than importing energy to a building. Passive systems are simple, have few moving parts, and require no mechanical systems to help them operate.



Figure 18: Multi-family housing can be sustainable and aesthetic. This Swiss three-family building won the 2010 Passivhaus Architecture Award. (Source: www.halle58.ch).



Figure 19: Housing units in the Beddington Zero Energy Development (BedZED) in south London use half the energy and water of comparable units in the surrounding area. (Source: bioregional.com).

Direct/Indirect Gain

Solar gain is most easily captured through the use of thermal mass, such as masonry concrete or Trombe (water) walls and roofs. Direct/indirect gain can benefit building occupants both in cooling and heating. Thermal mass storage requires special consideration of materials and thicknesses of surfaces. A thermal storage material works best if it is a dark color. Thermally massive materials help moderate indoor temperatures and reduce the possibility of extreme indoor temperature changes.

During the day, the building absorbs solar heat and internal loads. At night, cooler outdoor air circulates through the building, reducing the heat gained during the day. This allows the massive material to restore its properties so that it can absorb heat the following day. Success from this method is highly dependent on local climate conditions and requires professional consultation.

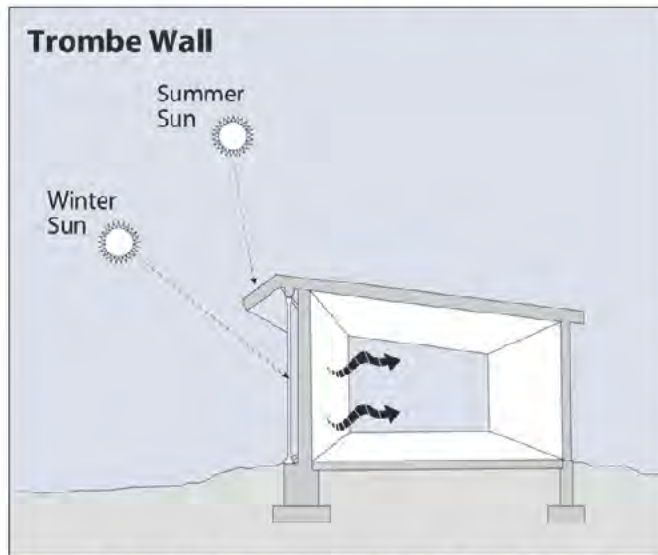

Figure 20: Passive solar design: Trombe (water) wall.

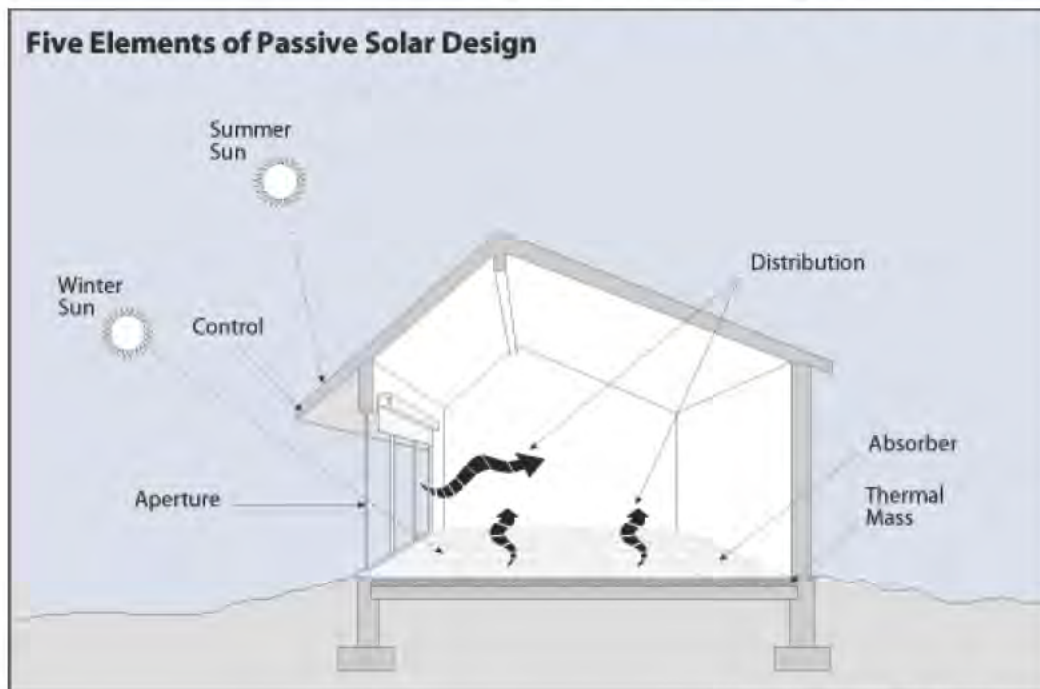

Figure 21: Passive solar design.

Because this strategy depends upon extensive outdoor airflow, large window openings are required. The use of large openings affects the placement of interior spaces and can be a security concern.

A direct gain system requires east/west site orientation in order to receive optimal seasonal solar heat gains from the south side of the building. It is important to consider the location of functional spaces in relation to the east/west orientation. Rooms that are placed along the south façade will receive more heat and daylight. North-facing spaces are optimal for service spaces such as closets and walkways and can create an insulation buffer. North-facing rooms are also good for cooling dominant spaces and are most commonly used in commercial buildings. Exterior shading and light shelves are important design criteria to consider in relation to energy efficiency. Light shelves push light farther into rooms, reducing the need to turn on lighting. Exterior shading can be accomplished through the use of landscape planting, which can prevent heat from the sun from penetrating into rooms and decrease the need for air conditioning. Vegetation can also act as an insulation buffer; appropriate plant species should be chosen after consulting with a professional.

Cross Ventilation

Air temperature and wind speeds are two key determinants in calculating effective cross ventilation systems. Cross ventilation works when the outdoor air temperature is 3°F cooler than indoor air and when wind speeds are high enough to cool the specific site based on its location and climatic condition. Greater airflow results in greater cooling capacity. Window placement is also a key design factor. Windows placed at occupant level will affect occupant sensation perception, while higher windows allow warm air to escape the building.

Shading

Adding shading devices to the exterior facade to shade south, east, and west exposures can minimize heat gain during the hot summer months. Alternatively, deciduous trees can shade windows during warm weather, while allowing sunlight to penetrate during the winter. Trees and shrubs can effectively act as barriers to unfavorable wind patterns by reducing wind speeds that cause a wind-chill effect. A simulation study by E. Gregory McPherson (1993) found that a 24-foot-tall deciduous shade tree planted on the west side of a building could decrease air conditioning requirements by over 150 kWh per year in Portland, Oregon (McPherson 1993). Since buildings on the Glen Creek site are generally not equipped with air conditioning, this savings translates to a higher degree of comfort during the summer. When designing for Orchard Village, it is important to think about how energy use can be reduced; carefully placed trees can not only help shade a building, they can add to the aesthetic value of the development.

Renewable Energy Systems

Drain-water (Graywater) Heat Recovery

80-90 percent of an average home's energy used to heat water is sent down the drain after use. A heat recovery system harnesses this heat and uses it to heat incoming cold water. The wastewater from sinks, showers, the dishwasher, and clothes washers can be harnessed and reused. This system may be more viable with new construction.

Solar Water Heaters

Solar water heaters (see Figure 22) reduce the use of purchased energy and are most commonly used for heating water. Less often, they are used for heating spaces. There are five different solar water heater options: thermosiphon, direct circulation, indirect circulation, water heating, and space heating. Considerations depend on climate, projected loads, and the desired purpose of the heater; in this case, we recommend an indirect (closed loop) system. With this

On average, a solar water heater can save 20% to 50% of energy costs, compared with conventional water heating systems (www.energysavers.gov 2010).

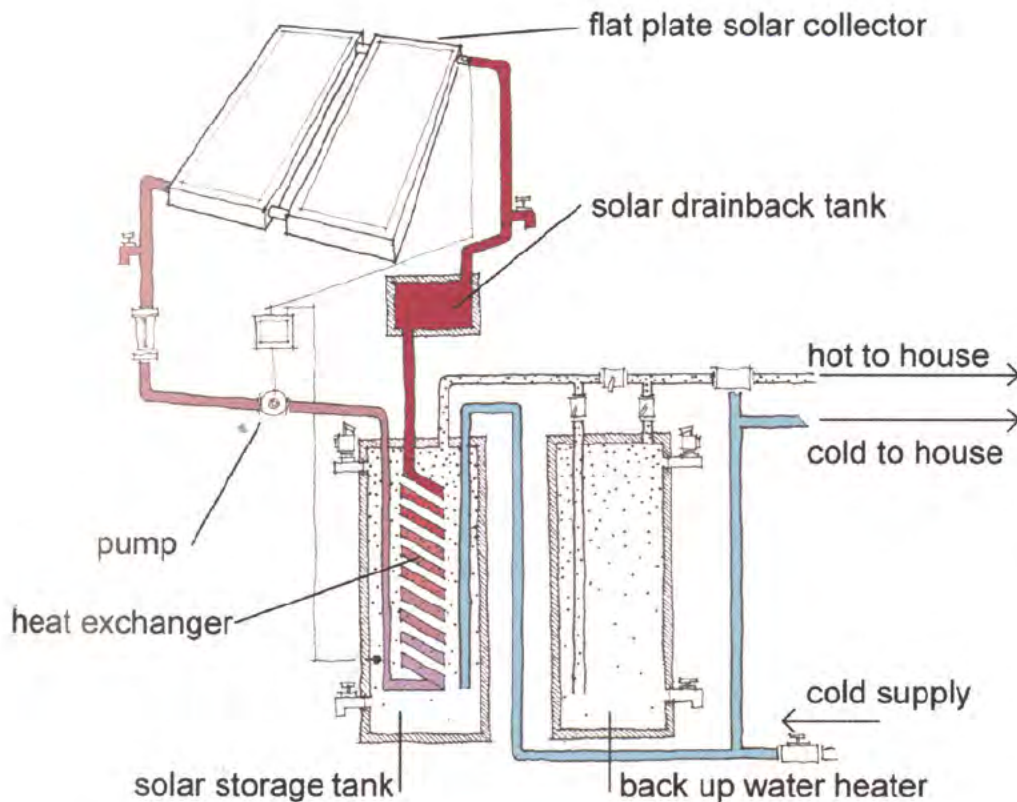

Figure 22: Solar hot water system diagram.

system, pumps circulate a non-freezing fluid through solar collectors and a heat exchanger, which heats water in an insulated tank.

Ground Source Heat Pumps

Ground source heat pumps (see Figure 23) use the earth's mass to heat or cool spaces. This type of system requires extensive site planning and varies in price.

The cost of a ground source heat pump is dependent upon the depth at which the piping needs to be buried, which varies with the frost line. Ground source systems consist of a heat pump, an air delivery system, and a heat exchanger. The pipes can be buried either vertically or horizontally. The decision about pipe placement will need to consider current site conditions as well as the possibility of future site development.

Ground Source Heat Pumps use 25-50% less electricity than conventional heating or cooling systems (www.energysavers.gov).

Air-to-Air Heat Exchangers

An air-to-air heat exchanger is a system that uses a mechanical device to transfer the heat from one airflow stream to another. The key architectural issue is the plan for two air streams (supply and exhaust) to run adjacent to each other at the connection to the heat exchanger. We recommend considering two types of units: heat recovery ventilators, and energy recovery ventilators. When deciding on a device, climate and outdoor airflow should both be considered.

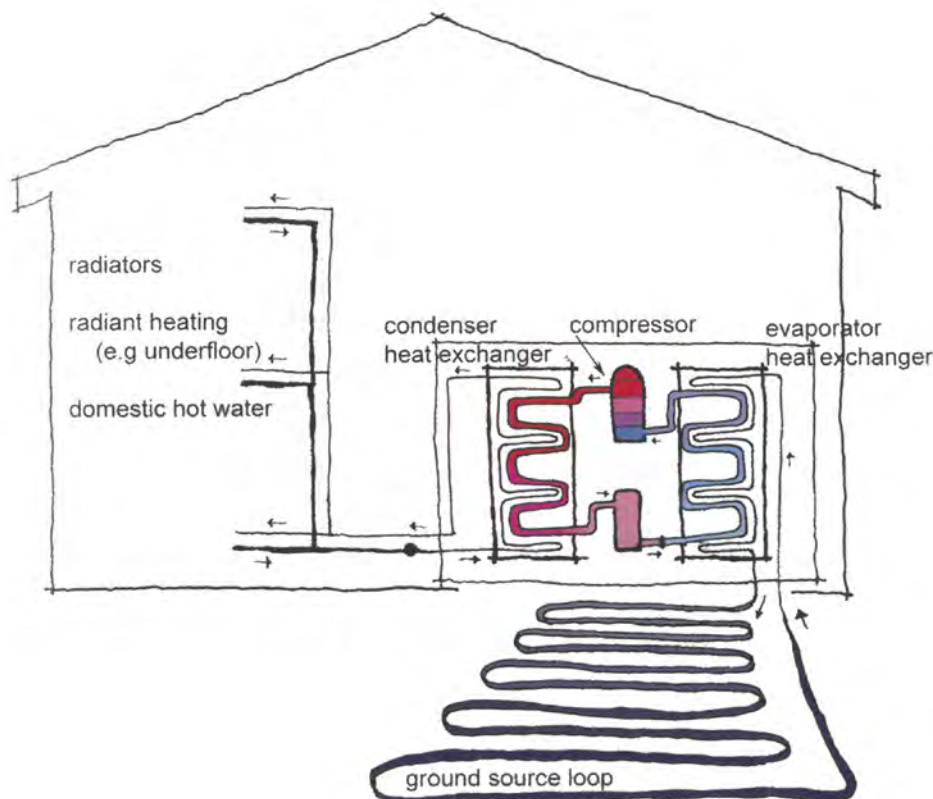

Figure 23: Diagram of a ground source heat pump used for space heating and hot water.

Combined Heat and Power (CHP)

Combined heat and power, or cogeneration, is the simultaneous production of electricity and heat or steam (see Figure 24). Production plants range in size from large industrial plants to small micro-stations used in private residences. Cogeneration plants convert up to 90% of their inputs into useful energy. This is due to a process that recovers the heat often lost as “waste.” Less energy is lost in transport because plants are closer to the energy purchasers.

Photovoltaic Panels

Solar photovoltaic panels are a system of solar energy harvesting reliant upon both the placement of panels and access to direct sunlight. Panels can be used to connect to the electrical grid, or as a standalone system. A “grid-connected” system requires less equipment and space than that of a standalone system, and can be beneficial when there is no access to solar power (caused by cloud cover or shade). In the case of Orchard Village, we suggest a system connected to the grid be used. If Orchard Village cannot produce all of its electricity, a local electric utility can supply the balance of residents’ needs. Additionally, if Orchard Village produces an excess of electricity, it can be sold back to the utility. A connection to the grid will require coordination with the utility companies.

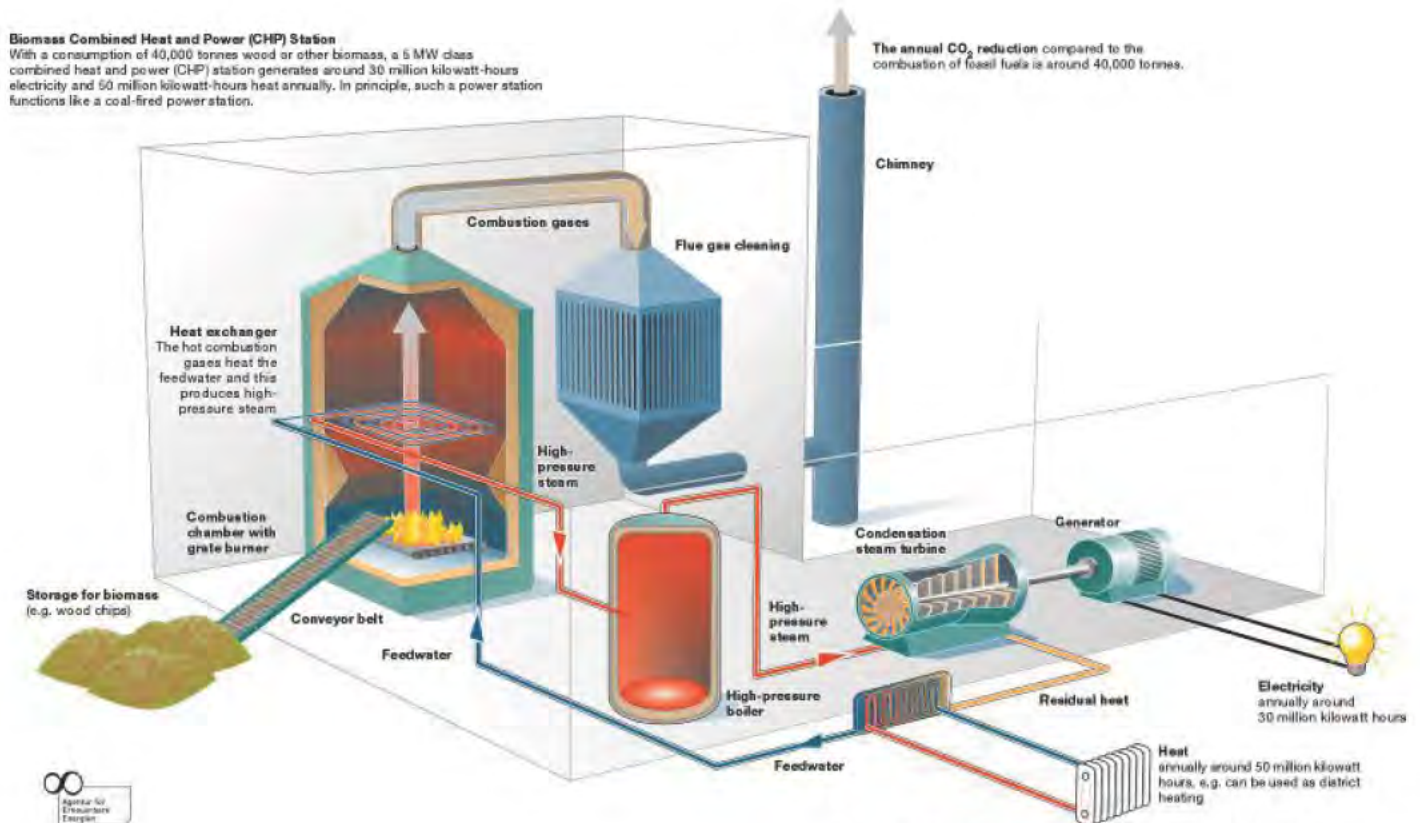

Figure 24: Biomass combined heat and power station.

Wind Harvesting

Wind harvesting uses turbines to harvest the kinetic energy of wind to produce energy for building use. Air pressure from wind spins the blades of the rotor, and the rotor spins a shaft that is connected to a generator, which in turn produces electricity. It is key to assess wind resources and tower construction regulations. Given Salem's available wind, it is unlikely that on-site wind power is a feasible option.

Fuel Cells

Fuel cell systems (see Figure 25) use an electro-chemical process rather than combustion to convert fuel into electricity. This results in a quieter, cleaner, and more efficient energy generation method. Fuel cells are most appropriate for building types with 24-hour loading and when coupled with either a biomass gasifier (which provides natural gas to power it) or combined heat and power (which could use the waste heat), both of which are explained below. This is an emerging technology and least documented as an integrated energy generation component. Fuel cells have reduced energy service costs by 20 - 40 percent in some places (wbdg.org 2010).

A manufacturer estimates that a Fuel Cell System enables homeowners to save 60% on their utility bills per year (www.houselogic.com 2010).

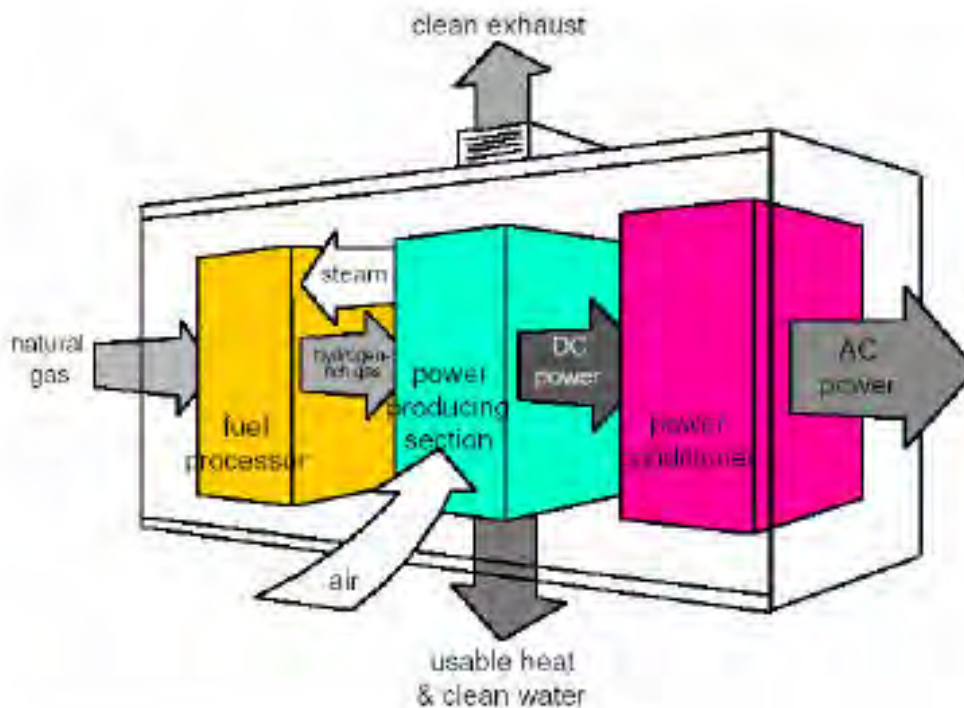

Figure 25: Fuel cell.

Barriers to Implementation

Financial

Available Grants and Incentives

The Alliance to Save Energy gives a general overview of possible funding options to increase energy efficiency in low-income housing (Alliance 2006).

These options include:

- Internal funds within SHA's operating budget
- Debt financing through private lenders
- Lease and lease-purchase agreements with the residents
- Energy performance contracts entered into with a third party, such as an energy service provider
- Utility incentives: Salem Electric will pay 50% of the cost (maximum \$10,000) of a design study to identify energy saving measures for the project, and will pay 12 cents per annual kWh saved upon completion of the project and inspection by Salem Electric staff (minus any payments made for the design study) (Salem Electric).
- State and federal financial assistance, e.g. Housing and Urban Development (HUD), Department Of Energy (DOE). Example: HUD Assisted Housing Stability and Energy and Green Retrofit. Description: Grants and loans will be made available through HUD's Office of Affordable Housing Preservation (OAHP) for eligible property owners to make energy and green retrofit investments in the property, to ensure the maintenance and preservation of the property, the continued operation and maintenance of energy efficiency technologies, and the timely expenditure of funds. Physical and financial analyses of the properties will be conducted to determine the size of each grant and loan. Incentives will be made available to participating owners. The terms of the grants or loans will include continued affordability agreements. The receiving property owner must spend grant and loan funds within two years. Eligible owners may receive up to \$15,000 per apartment unit (Portal HUD).
- Partnering with university-based research, utilities, and small business owners may open other avenues for receiving grants, such as those funded by the US Department of Energy's Small Business Innovation Research program. Salem Electric has stated that they would be open to proposals along these lines (Salem Electric correspondence 2010).

Social

Social perceptions and preferences may prevent or limit the effectiveness of energy use reduction strategies. Some residents may feel that energy conservation reinforces a negative perception of low-income housing. Lack

of time, knowledge, and money are also barriers to individual participation in an energy-use reduction scheme. Overcoming these barriers should involve a systematic and community-wide program of education, as well as social and financial incentives. Occupants' preferences for particular appliances, interior finishes, or other individual unit attributes may also present difficulties. These may be addressed by consulting closely with the residents when alterations are proposed, allowing them to provide input while informing them about the reason for the changes.

Changes to Social Structure

Increasing Density

Higher residential density at Glen Creek may be achieved by splitting some of the larger townhomes into smaller units, similar to dorms or single-room occupancy (SRO) housing. This method would provide residents with one or two bedrooms and a bathroom for personal use, while reserving the kitchen and living area for shared use (see Figure 26). Rents could be reduced, and the high demand for smaller units (since Glen Creek has only 3, 4 and 5 bedroom units) could be met more easily.

Workshop and Training

We recommend giving all new residents information and instruction on ways to conserve energy, such as water conservation, room heat management, recycling, and composting. Part of this training should include instructions on reading a utility bill and meter. We suggest posting tips in public places for

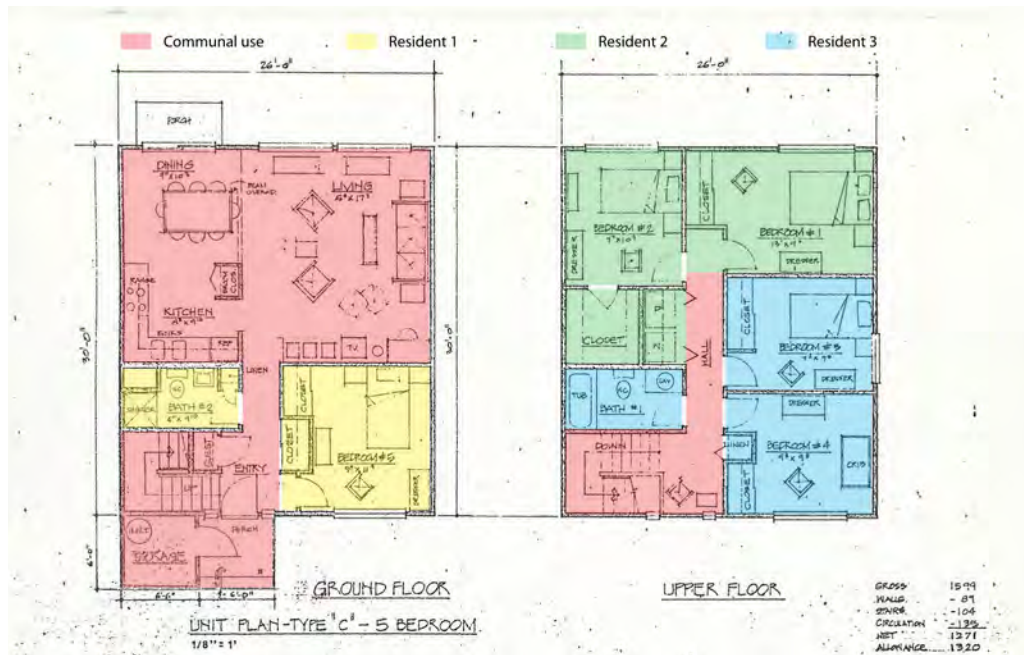

Figure 26: Proposal to convert large Glen Creek townhome into multiple units with shared common areas.

residents to reference and providing a move-in booklet for each unit with all the information in written form that is easy to reference.

Incentives

We suggest that SHA use creative means to empower and engage residents towards smart energy use. A reward system for keeping energy usage low may be appropriate. If residents are able to track their energy use by reading the meter for their individual unit, there becomes an incentive to keep energy down, because they will see their meter and their power bill.

Proposal

Pivotal: Educate; devise a holistic site-wide energy strategy; for Glen Creek, upgrade building components (e.g. insulation, doors and windows, interior finish materials). When designing new buildings (e.g. at Orchard Village), look for the 'free' things: sun, wind, and water.

Progressive: Replace aging appliances with high-efficiency models; install master switches in each unit; provide outlet-based electrical use monitors (similar to the Kill A Watt or Watts Up). Buy renewable power through Salem Electric.

Pioneering: Incorporate a renewable energy generation strategy: on-site photovoltaic panels and solar hot water heaters. Any new construction (e.g. at Orchard Village) strives to be net zero energy.

Water

Strategies for Smart Water Use

Urban Water Use

Even in rainfall-rich regions such as the Pacific Northwest, water conservation and security are pertinent issues that will grow in importance as more people move to the area. Many of the following suggestions will address stormwater mediation, the most crucial challenge on the Orchard Village site. Addressing water issues at Glen Creek and Orchard Village will help:

- Manage water in a conscious and sustainable manner to avoid pollution and depletion of water sources (increase water security).
- Reduce demand on external water sources (groundwater, reservoirs) which replenishes the aquifer.
- Reduce stormwater runoff into surrounding streets and Glen Creek, limiting erosion, water pollution, and flooding.
- Increase biofiltration capacity, which improves groundwater quality.
- Lower water utility bills for residents.

In addition to these water-oriented benefits, vegetating bioretention features with native plants can provide habitat for native wildlife.

Site-specific water table depth and soil infiltration capacity should be confirmed before implementing most of the following strategies.

Water Conservation in the Home

Efficiency in water consumption is an important element of comprehensive water management. Water conservation at the resident level results from the combined efforts of educational measures, behavioral patterns, and efficiency of home appliances.

In a study conducted by Geller, Erickson, and Buttram involving 63 townhouses and 66 single family residences in Blacksburg, Virginia, different strategies of water conservation (behavioral, educational, and engineering) were tested against one another to determine their comparative effectiveness. Of the three methods, installation of water-saving devices in the home (engineering) was vastly more effective in conserving water than both distribution of educational pamphlets and individualized water consumption feedback reports.

In the Blacksburg study, the four water conservation devices installed in the homes were:

- Toilet dams, which reduce the amount of water in a conventional toilet used per flush while retaining effectiveness.

- Shower flow control devices, which reduce the amount of water emitted from shower heads while retaining flow pressure.
- Aerators, which fit onto faucets and mix air with water to achieve the same effect as flow control devices.
- Shut-off shower control devices, which allow showers to be turned off without resetting water temperature.

While the Blacksburg study was published in 1983, all of the referenced devices are still effective, inexpensive water conservation tools that can contribute to reducing water consumption. By adding minor retrofits such as aerators and toilet dams to all residences (at a cost of \$1-6 per device) and checking faucets and pipes for leaks, efficient usage of water can be significantly improved.

On average, the households with water-saving devices installed saved 17 gallons of water a day, whereas the other two groups saved an average of four gallons a day (Geller 1983).

Water Conservation Systems On Site Grounds

The landscape of Glen Creek is a large, rolling lawn. Nicole Utz of SHA has identified the landscape as a “maintenance nightmare,” in terms of mowing and irrigation. To reduce maintenance cost and water usage while simultaneously avoiding unsightly dead grass, we recommend dedicating sections of current lawn space to rain gardens and swales vegetated with native plants, which would meet aesthetic standards and require no irrigation. This would reduce the amount of lawn maintenance, while simultaneously contributing to water security. We recommend watering the remaining lawn early in the morning instead of the heat of the afternoon, in order to avoid water lost to evaporation.

Rainwater Harvesting Opportunities

Capturing and storing rainwater reduces the amount of water purchased from the community infrastructure by providing an on-site water supply. Concurrently, rainwater harvesting reduces the amount of water entering the Salem stormwater system.

The range of immediate applications would depend on potential contaminants in the water collected. Collected water can immediately be used for irrigation and gardening, however, treatment would need to occur for laundry and other household uses.

There are two categories of rainwater harvesting systems: simple and complex. Both can be feasibly implemented at the Glen Creek and Orchard Village sites.

Simple Rainwater Harvesting Systems

These systems use the collected water immediately, directing it from the catchment source to planted areas via distribution systems, which typically operate by gravity (e.g. downspouts, hillsides, and sloped impervious surfaces). The planted areas usually contain native riparian edge species. Theoretically, a simple rainwater harvesting system could be as straightforward as a driveway angled at a 2 percent slope (Waterfall 1998) directing runoff from its surface into a vegetated, bermed depression in the landscape (see Figure 27). Other simple systems can consist of directing rooftop runoff into planted areas near the house (rain gardens) or into French drain systems. With careful direction of spouts and attention to gravity, there are several creative options for directing rainwater into simple catchment systems.

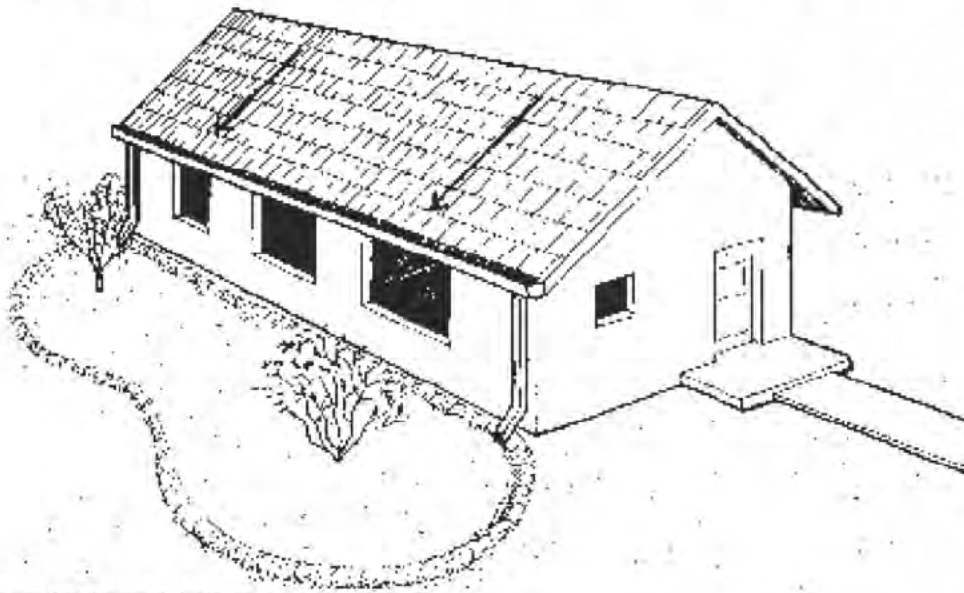

Figure 27: Bermed holding area.

Complex rainwater harvesting systems

These systems include the element of storage. Rainwater is directed from a collection surface (usually a rooftop) to a storage tank or series of tanks. Generally, such tanks are located above ground, although the option of underground storage exists (see Figure 28).

If rooftop catchment and storage systems are a desired future element of the sites, a feasible first step is storing water to irrigate gardens and landscaping. Ultimately, water collected through rainwater catchment could be used for flushing toilets, washing dishes and laundry, or even drinking (with proper filtration and mineral amendment). See Figure 29 for rough estimates of rooftop surfaces at Glen Creek.

According to Weatherbase.com, which compiled 48 years of precipitation data to arrive at average monthly values, December is the month with highest

precipitation in Salem, at an average of 6.7 inches. A calculation used to determine needed cistern capacity is:

$$V \text{ (volume of collection in gallons)} = R \text{ (precipitation, measured in feet)} \times A \text{ (footprint of collection surface in ft}^2\text{)} \times k \text{ (conversion from ft}^3\text{ to gallons, 7.48 gal/ft}^3\text{)} \times e \text{ (efficiency of collection surface: unitless, 0.8 average)}$$

This formula and the rough estimates of roof area, we can determine approximate water storage tank sizes necessary to contain all of December's rainfall (about 68,000 gallons).

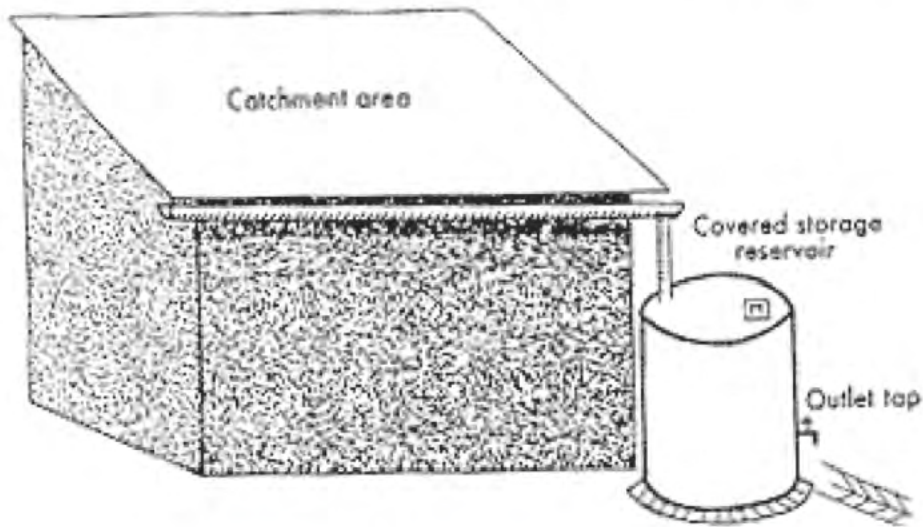

Figure 28: Catchment system.



Figure 29: Estimates of roof area at Glen Creek.



Figure 30: Roadside bioswale.

Bioswales

Bioswales are on-site landscape components designed to capture and clean stormwater runoff through phytoremediation (Vollum 2010). The runoff is directed and filtered through particular vegetation planted within the swale. These plants are chosen for their ability to filter toxins and environmental pollutants out of the water, cleaning the water before it enters back into the watershed or is used for other purposes. Other components used for filtration include gravel, stones, and clay. Bioswales are channels for filtration not intended for long-term water storage. Once the runoff completes filtration, it may “infiltrate the soil, flow into a retention/detention pond, or discharge to a storm sewer system” (Kwok 2001).

Many swales are non-compacted water harvesting ditches constructed along topographical contours in the landscape. They slow water runoff, spread it throughout the swale, and provide a way for water to infiltrate into the earth, replenishing the water table and irrigating the swales. The swales can be planted with fruit trees, berry bushes, native plants, or other desirable edible, native, or aesthetic landscapes.

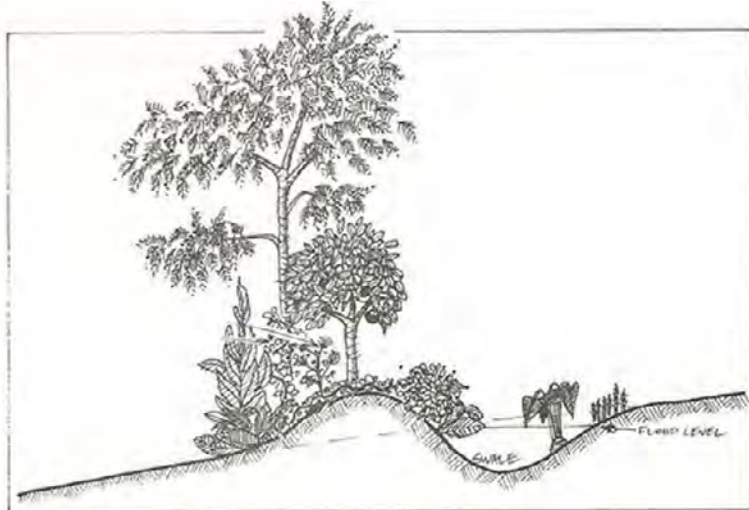

Figure 31: Bioswale cross-section.

Dry swales may be the optimal type of bioswale to employ at Glen Creek and Orchard Village, considering the safety and use as a residential site. The top of dry swales remains relatively dry, while the bottom is capable of holding water with runoff directed through the bottom of the swale. The base of a bioswale needs to lie at least two feet above the water table.

Recommended Location for Bioswale on Glen Creek Site
Along the west/northwest border of Glen Creek, there is a steep

incline in the hill. Utz identified it as a potential site for a parking garage or the possible construction of a building. If future construction on this portion of the site proves infeasible or undesirable, its steep topography would be ideal for a

swale. Other potential swale sites could be along the south border of the site or the southeast corner, adjacent to the community building (see Figure 32).

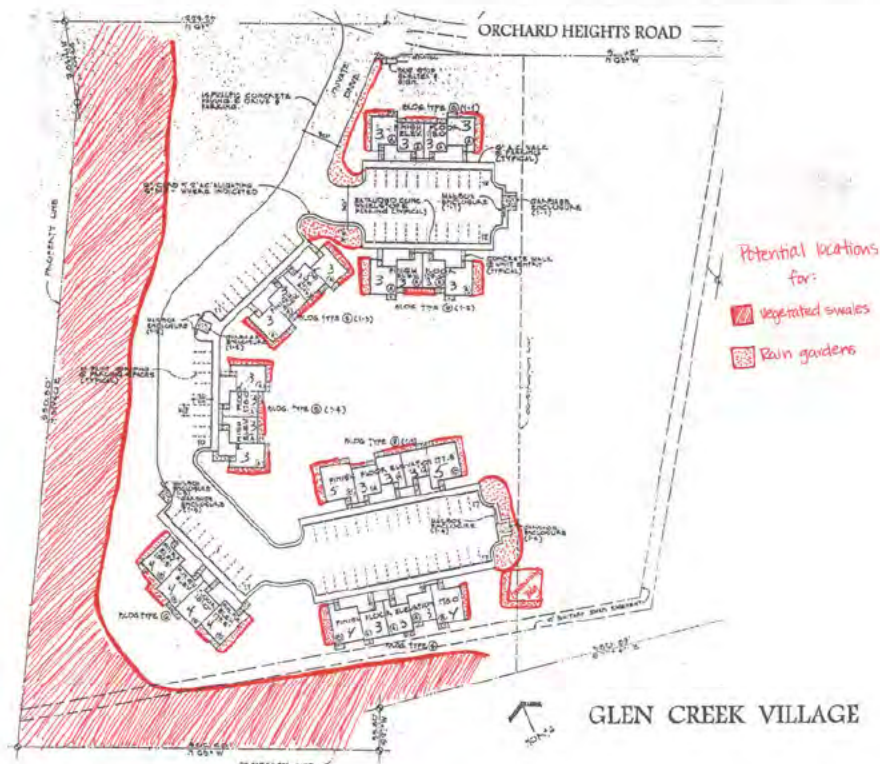

Figure 32: Potential locations for bioswales and rain gardens at Glen Creek Village.

Preliminary Steps

Before comprehensive rainwater management is implemented, it is important that drainage patterns on both sites are carefully observed to gain a solid understanding of the way water currently behaves on the landscape. This will provide a strong foundation on which to base future rainwater direction plans.

Retention Ponds

Retention ponds provide a site for bioremediation, reduce stormwater runoff into the community wastewater treatment system, and enable on-site water recycling. Unlike detention ponds, which are essentially bioswales with longer-term temporary storage capacities, retention ponds provide a place for runoff to remain until it either evaporates or enters the soil. During the water's retention, "bioremediation methods can be included using soil bacteria, fungi, and plants to remove pollutants" (Vollum 2010).

A water table depth greater than six feet is required to implement this strategy. Since excavation is required for retention ponds, it is important to plan for this

strategy early in the design process, and assess its feasibility at both Glen Creek and Orchard Village.

Pervious Surfaces

Pervious surfaces are “Ground covers that allow rainwater to infiltrate and flow through to subsurface layers” (Kwok 2007). Pervious surfaces are composed of porous materials that can support human and vehicular traffic depending upon the material chosen and are effective for parking lots, driveways, sidewalks, and patios. Such materials include permeable pavers and porous asphalt. Gravel and mulch can also act as pervious surfaces when incorporated into site landscaping. Pervious surface materials slow stormwater runoff, thereby relieving stress on Salem’s water management infrastructure as well as reducing runoff of on-site pollutants.

According to the information provided by the City of Salem, the four closest groundwater wells to the Orchard Village site had a water table level deeper than the minimum four feet required for the use of pervious surfaces. Prior to proceeding with design and construction of a pervious infrastructure, site-specific water table analysis needs to be completed. When designing a pervious surface site plan, note that the minimum recommended setback from building foundations is 10 feet, and the minimum setback from water supply wells is 100 feet. We recommend contacting local Salem businesses, such as Evolution Paving Resources, for more information and possible bid estimates.

Green Roof

A non-accessible green roof, with 3” to 5” sedums, would provide an affordable green roof solution with many long-term benefits. Green roofs provide several environmental benefits including filtering air pollutants, absorbing carbon dioxide, providing habitat for pollinators, reducing the “heat island effect,” and decreasing stormwater runoff. The retained runoff may be stored on-site for treatment and used through a water catchment system (Kwok 2007).

The additional weight of water held within the roof system may require additional structural support for the existing buildings at Glen Creek. However, for an non-accessible green roof, this should be minimal. It may also be

A green roof extends the life of the roof, when compared to traditional construction, by 20-40 years with very low annual maintenance requirements.

necessary to incorporate an irrigation system into the roof to maintain green roof health during the dry season. Traditional roofs cost \$3 - \$15 per square foot with significant maintenance requirements, while a green roof costs \$10 - \$20 per square foot. Additionally, areas such as Portland have instituted substantial subsidy benefits making green roofs more affordable (Vollum 2010).

Graywater Systems

Graywater Irrigation

A graywater treatment system conserves water on site by reusing water that does not contain human waste (Vollum 2010). Water containing human waste is termed blackwater and is not recyclable or reusable within this context.

In a graywater system, rather than water going directly to the sewage system after a single use, it can be reused to flush toilets, irrigate the landscape, or assist in building heat recovery. The conservation benefits of a graywater system lead to long-term cost savings at both the building and community scale. According to The Green Studio Handbook, “The ideal building type for a graywater treatment system is a high-occupancy residential building” (Kwok 2007), making this a great option for Glen Creek and Orchard Village.

Graywater can recycle 50–80 percent of household water from kitchen and bathroom sinks, dishwashers, laundry machines, and showers. Additionally, graywater can save \$5-20 per month on water bills (Lens 2001).

Benefits of Graywater

- Reduced fresh water use
- Reduced strain on septic system or treatment plant
- Groundwater recharge
- Increased plant growth in dry areas
- Maintenance of soil fertility
- Reduction in water bills

Our research indicates that graywater irrigation systems may be hard to implement and have a low cost/benefit ratio for current standing buildings, yet for the construction of new buildings, graywater irrigation is beneficial.

At the Glen Creek site, areas that currently require irrigation are lateral to Glen Creek and/or are located in the flood plain on the east side of the site. If the soil is too moist and permeable, proper filtration of the graywater will be unsuccessful; it will flow straight into Glen Creek and contaminate it. Since the west side of the site is not designated as floodplain, and the area is distant from Glen Creek, a graywater irrigation system could be more practical in this location. If native plants and deciduous trees are planted in the area, graywater could successfully irrigate many of these plants. Additionally, graywater may eliminate the need for watering in the summer months, thus decreasing water bills.

Barriers to Implementation

Financial

Construction of storage devices for rainwater generally outweighs the cost of water, making the investment payback lengthy. In this case, a commitment to long-term water conservation and self-reliance would be necessary. It may be

more feasible initially to use simple rather than complex rainwater harvesting systems to avoid renting costly machinery.

Social

It is important to consider the additional maintenance requirements for many of these strategies. An educational component will be necessary to ensure the smooth functioning of each strategy and strengthen public knowledge of environmentally sensitive design.

Specific requirements for a graywater system: residents would be required to buy specific soaps and shampoos for the graywater system, which would require them to shop in specific locations and spend additional money. It may prove difficult to regulate residents' use of soaps and washing techniques for a successful system.

Proposal

Pivotal: Adding minor retrofits such as aerators and toilet dams to all existing residences. Checking faucets and pipes for leaks. Replacing some of the current grassy yard with native plants.

Progressive: Installing non-accessible green roofs. For all new construction, installation of rainwater catchment systems and bioswales.

Pioneering: Implementing a graywater system.

Agriculture

Gardens and Landscaping

Healthy dietary choices are often not viable options for low-income families because government subsidies make local produce more expensive and less accessible than imported produce or processed foods. The greater Salem area is fortunate to have productive agricultural land, yet the majority of food consumed in this region comes from great distances. The following suggestions consider options for the current Glen Creek site and the future Orchard Village site to contribute to local food consumption and make buying local a reality for low-income families.

On average, processed food travels from farm to mouth in America over 1,300 miles, and fresh produce travels over 1,500 miles (Hill 2010).

Addressing agricultural and landscaping options will benefit Glen Creek and Orchard Village residents by:

- Making food, particularly food high in nutrients, more accessible to residents
- Increasing community involvement
- Addressing environmental concerns by reducing the carbon footprint of food inputs and outputs of the SHA developments
- Fostering a sense of stewardship in the community towards the land and self-grown food

By pursuing these options, Salem has the opportunity to help provide food security to public housing residents in a sustainable and environmentally conscious way.

Glen Creek as an Agricultural Zone

The Glen Creek property is agriculturally zoned, indicating that the soil is Class I - IV in Western Oregon (Oregon Planning Guidelines 2010). Along with healthy soils, agriculturally zoned sites recognize a priority to keep agriculture active on the land. Therefore, there may be opportunities for government support for on-site food production.

The USDA Web Soil Survey offers accurate mapping of soils across the nation. Figure 33 on the following page shows the output of the Web Soil Survey for Polk County, cropped to the Glen Creek area of interest. Light green indicates “farmland of statewide importance,” while the darker green indicates areas that are “prime farmland.”

The City of Salem has increasingly supported urban farming in the last few years as numerous community gardens have been established and programs like Marion-Polk food share are very successful. Figure 34 shows the locations

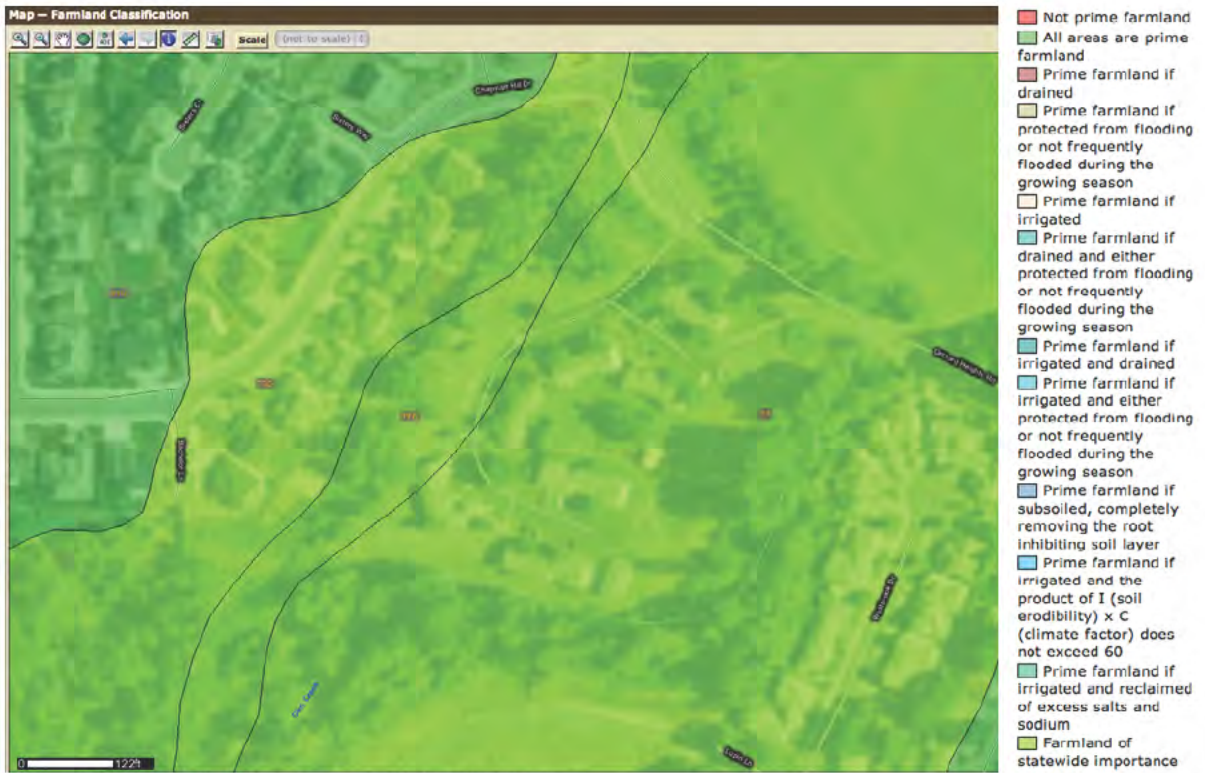

Figure 33: USDA Soil Survey map of Glen Creek area.

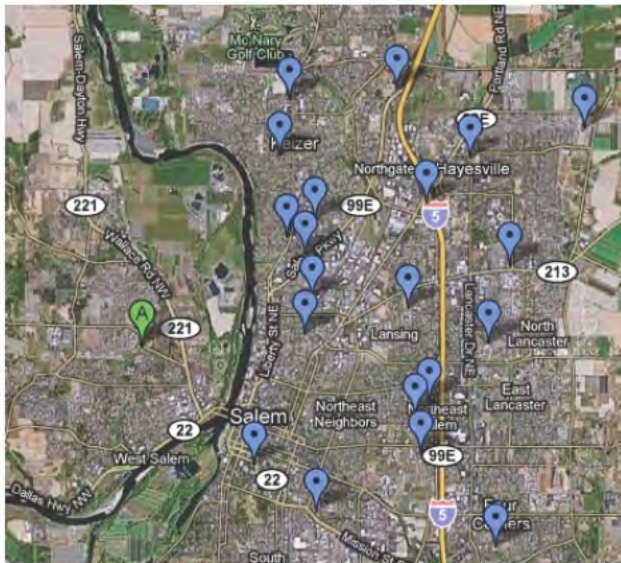

Figure 34: Community gardens in the Salem area.

of Marion-Polk supported community garden projects in the Salem area, with the 'A' pin locating the Glen Creek property. While this map does not show all community farm locations, as there is one located across the street from the Glen Creek property, it does show the significant number of community garden projects within Salem, particularly west of the Willamette River (Marion Polk 2010). Clearly, the City of Salem is encouraging community garden projects.

Gardens

A garden provides an on-site food source for residents, as well as an opportunity to connect with food. Across the United States, success stories of

neighborhood gardens show increasing community interaction as well as food security growth.

For Glen Creek, we recommend that gardens be located on the northeastern side of the property. This area is noted as a floodplain, with no buildings blocking the sunlight, as can be seen in Figure 35, with the large red area indicating potential garden space. This provides a large area, approximately a quarter acre, with the potential of growing a variety of crops (Salem, OR. avg. temps. 2010). With good planning, there is potential to harvest throughout the year.



Imagery ©2010 DigitalGlobe, GeoEye, State of Oregon, U.S. Geological Survey - Terms of Use

Figure 35: Glen Creek food production location (large red box).

Organization Models

Individual Garden Plots Near Unit

Depending on how new housing units are built at Orchard Village, there may be a small garden space for each individual unit near the front or back entrance. Additionally, we recommend providing at least one window plant box (ideal for growing small vegetables, herbs, and flowers), for each unit at SHA sites. This feature could also be an easy addition to the Glen Creek Apartments.

The community garden in Orchard Heights Park (across the street from Glen Creek) has a waiting list for their garden plots.

Community Garden Model

Community gardens can be organized, depending on the overall goals of the garden, in many ways. In Seattle, Washington, the city housing authority has initiated a “P-patch” program in alignment with the Urban Garden Share. The city housing authority set up a network so gardeners can sign up with a

community garden and pay for a plot. Seattle gardeners unable to afford a plot can apply for plot fee assistance through the housing authority.

This model of plot division demonstrates how city support can ensure the stability of community gardens. If a gardener cannot afford a plot, the city will help ensure that the fees do not become a barrier. Salem currently has numerous community gardens under a similar model.

We suggest the Glen Creek and Orchard Village gardens give priority access to residents. SHA will need to assess the feasibility of fees, with the option of no fees for residents. The sites have potential to set aside plots for outside community members, where fees would be appropriate. This would provide income to support the garden and create an opportunity for knowledge exchange within the greater community.

Neighborhood-Education Link Model

There has been a fast growing Farm to School movement across the country. Educators are realizing the potential of urban farms and gardens to educate students. The State of Oregon has acknowledged the Farm to School initiative and appointed a full time position to manage Farm to School programs. Most major Oregon cities have initiated programs; however, Salem has yet to get involved (www.farmtoschool.org 2010).

From biology to healthy diets, cooking to environmental studies, students connect with the curriculum through food production. Throughout the school year, classrooms work in the garden, learning practical gardening skills as well as plant biology. During the weekend, students may help run a community farmers’ market, and during the summer, high school students find employment by working in the gardens.

There is potential for SHA gardens to make a similar connection, particularly for residents of low-income housing units, by providing accessible education to the

resident youth, and by promoting healthy eating habits inside the home. There is potential for an outside organization to set up education programs using the on-site outdoor kitchen (discussed below) to provide classes in cooking, gardening, and health. Expanding community partnerships may be ideal. For example, funded by a \$3,000 grant from New Seasons Market, Portland, Oregon developed a “Mobile Farmers’ Market” program that allows a staff member to buy from weekly farmers’ markets and sell produce to low-income neighborhoods in Portland via a mobile van (Parker 2009).

Salem could become a leading city in the Farm to School initiative by setting up a program that not only connects youth to farms, but also gives low-income families an opportunity to get involved. A satellite education program could go as far as seeking funding as a charter school by getting educators involved in the project. Organizations to contact for potential involvement are listed in the References section.

Resident Garden with Outside Volunteer Support Model

This model focuses strictly on the residents at each site. It recognizes that there may not be enough support from the residents to maintain the garden year-round, and thus seeks an organization to help sustain the garden. This organization could also provide educational resources to the residents and weekend workshops on topics such as cooking, gardening, and health. There



Figure 36: Community garden.

are many food security grants that could fund this kind of initiative on the state and national level.

Intensive Food-Producing Habitable Green Roof

As a habitable space, the intensive green roof provides opportunity for food production and recreational terraces. Due to the increased weight of an intensive green roof, as well as the need to support the weight of occupants, the building would require additional structural support.

Beyond the Garden

In addition to an increased food supply for the residents of Glen Creek, landscaping has the potential to:

- Reduce erosion
- Provide shelter and food for native wildlife
- Offer educational opportunities for residents

Greenhouse

With a greenhouse, residents would be able to ensure on-site food security throughout the winter. There is a lot of open space at the Glen Creek property, and potentially plenty of space at the Orchard Village site, allowing room for a greenhouse. In addition, harnessing the heat of the sun makes greenhouses an environmentally viable option.

Native Species

In maintaining a sustainable focus, it is important to use native plants when possible. Native species are responsive to their region's climate, soils, and rainfall. These plants provide landscaping and conservation, and are often resistant to many insects and diseases. These factors decrease the amount of attention needed for the plants, therefore decreasing the necessary water usage, labor, and money. It is important to know not only the eco-region each species is native to, but also requirements for light and soil moisture, in order for the plants to grow successfully (Hansen 2010).

Herb Gardens

Small herb boxes lining sidewalks, backs of houses, and window boxes on every unit could expand the food landscaping throughout the site. Herb gardens are aesthetically pleasing and provide an opportunity for residents to learn about fresh herb use.

Fruit Trees

Salem's climate makes it possible to grow fruit trees without much maintenance. Planting fruit trees would broaden the scope of on-site food production and increase food security for the residents. Fruit trees that grow particularly well in Salem include apple, plum, and cherry.

Organization	Mission/goals and Current projects	Glen Creek Connection	Contact Information
Pathways to Possibilities Oregon 4-H Youth Development Program	<p>How do you bridge the digital divide? Ask Jose Cazares and his fellow 4-H Tech Wizards. When people in his community started falling behind, he and his team began training them to become a more tech-savvy workforce. The importance of responsibility and service was instilled in Jose early on at 4-H. And today, those are the values that will help our communities solve the many challenges they face.</p> <p>They currently have sustainable horticulture handbooks and project for the 4-H youth they be involved with.</p>	Glen Creek garden could provide a space for 4-H youth to practice some of the ideas behind being a 4-H. With a connection to 4-H, would provide huge resources to sustainable gardening, as well as an already established volunteer based community. 4-H youth could bring in cooking classes opened up to the residents of the Glen Creek property as well, and promote a bigger community involvement between Salem Housing Authority and Oregon youth programs.	<p>Marion County Extension Office</p> <p>3180 Center St NE Room 1361 Salem, OR 97301</p> <p>Pamela Rose (503) 588-5301 http://oregon.4h.oregonstate.edu/</p>
Friends of Straub Environmental Learning Center	<p>"In partnership with the community, we create awareness and understanding of our relationship to the environment."</p> <p>They are partnered with the Salem-Keizer School District, as well as the OSU extension service and Willamette University.</p> <p>Their work includes:</p> <ul style="list-style-type: none"> • Environmental Lecture Series • Household Ecology Workshops • Environmental Summer Camp • Family Science Night • Site for community meetings and dialogue on environmental and sustainability issues • Native Plant Landscape Restoration Site • Annual Spring Youth Summit 	This organization proclaims in their information video that "the sky is the limit in terms of what additional programs we could be offering." They are currently have very effective environmental education programs, mainly run by volunteers. The Glen Creek Garden could easily become an excellent environmental education program involving both the youth living on the site, and the youth of the larger community. Friends of Straub Environmental Learning Center already have the volunteers, and connections; Glen Creek would be providing them with an opportunity to expand their program.	<p>http://www.fselc.org/</p> <p>(503) 391-4145 fselc@fselc.org</p>
Oregon Extensions	<p>As the front door to Oregon State University, we provide access to the educational and research resources of the University through a wide range of programs and projects; high quality multimedia, print, and electronic publications; top-notch people working in many areas of expertise; and Extension offices throughout Oregon.</p> <p>They provide a Master Gardener Program, as well as involved in many projects in the Salem area, and is funded by the state through OSU.</p>	Both of the above programs are connected with Oregon Extension services. Just as the Sustainability Cities Initiative connects university students with community projects, the Oregon Extension Services would continue this idea on the Glen Creek site. It could connect with already existing projects, or create a new one, using students enrolled in the Master Gardener Program, to promote urban gardening, and education.	<p>http://extension.oregonstate.edu/</p> <p>101 Ballard Extension Hall Oregon State University Corvallis, OR 97331-3606 (541) 737-2713</p>

Figure 37: Making connections: organizations that could help establish or run community gardens in partnership with the Salem Housing Authority.

Organization	Mission/goals and Current projects	Glen Creek Connection	Contact Information
Farm to School	<p>Farm to School connects schools (K-12) and local farms with the objectives of serving healthy meals in school cafeterias, improving student nutrition, providing agriculture, health and nutrition education opportunities, and supporting local and regional farmers.</p> <p>Currently they have many programs set up throughout Oregon, however none in the Salem area. The programs are having very positive responses in getting public schools involved in gardening.</p>	<p>By aligning with The Farm to School program Salem would be joining a nation wide initiative to promote nutritional, and environmental education within public schools. Glen Creek would provide an excellent site to bring gardening, and education to the school system. This could evolve into a state funded charter school, and SHA would be pioneering initiatives to connect public low-income housing with environmental education. While schools based on programs like this are occurring nation wide, it is often based around the middle/upper class, here this project would be community based, giving everyone fair access.</p>	<p>Michelle Markesteyn Ratcliffe</p> <p>Farm to School Coordinator</p> <p>Ecotrust 5143 Sconce Road Hubbard, OR 97032</p> <p>(503) 476 6080</p> <p>mratcliffe@ecotrust.org</p>
AmeriCorps	<p>AmeriCorps members address critical needs in communities all across America. As an AmeriCorps member, you can:</p> <ul style="list-style-type: none"> • Tutor and mentor disadvantaged youth • Fight illiteracy • Improve health services • Build affordable housing • Teach computer skills • Clean parks and streams • Manage or operate after-school programs • Help communities respond to disasters • Build organizational capacity 	<p>To ensure a well-established volunteer system, as well as promote progression in an outreach program, connecting with AmeriCorps would be an excellent opportunity for the Glen Creek site. AmeriCorps could develop outreach programs for the Salem youth, and community development using the garden and outdoor kitchen area as a home base. Especially as the state capitol it is important to show connection with a larger American community, and AmeriCorps would help do this.</p>	<p>Oregon Coordinator</p> <p>Amy Dailey</p> <p>620 SW Main Street Room 714 Portland, OR 97205</p> <p>http://www.americorps.gov/</p>
Marion-Polk Food Share	<p>Established in 1987, Marion-Polk Food Share (MPFS) is a non-profit charity providing food for people at risk of hunger in Oregon's mid-Willamette Valley. Between July 1, 2009 to June 30, 2010, MPFS distributed \$8.9 million dollars worth of food—more than 6.9 million pounds—just to assist hungry residents of Marion and Polk counties.</p>	<p>Already connected with other public housing units in Salem, Marion-Polk Food Share is an excellent resource for the Glen Creek site. Promoting food security. MPFS could organize distributing excess food, as well as ensure that food distribution, and garden up keep is consistent throughout the year. With any program that SHA decides to pursue on the Glen Creek site, MPFS would be an excellent resource.</p>	<p>http://www.marionpolkfoodshare.org/</p> <p>1660 Salem Industrial Drive NE</p> <p>Salem, OR 97301-0374</p> <p>(503) 581-3855</p>

Figure 37 (continued): Making connections: organizations that could help establish or run community gardens in partnership with the Salem Housing Authority.

Organization	Mission/goals and Current projects	Glen Creek Connection	Contact Information
Environmental Science Program at Willamette University	The Environmental and Earth Sciences Department offers a comprehensive study of the natural and social sciences necessary for understanding human impact on the natural world. Our majors gain competence in both the natural and social sciences, enabling them to become contributing members of society. We emphasize critical thinking, persuasive and informed writing, competency in research and public speaking skills.	A garden program to connection environmental science students with a hands-on community outreach experience would provide Glen Creek with an excellent resource of volunteers and enthusiastic students. The University of Oregon has some exemplary models of outreach programs such as the Courthouse garden (http://uoregon.edu/courthouse-garden) or The Environmental Leadership Program (http://pages.uoregon.edu/ecostudy/elp/), which could help Willamette University to develop similar projects.	Administrative Assistant Faye D. Trupka (503) 370-6894 frupka@willamette.edu
Local Restaurants	Find a local restaurant that would be interesting in promoting sustainability, and buying local.	This could provide a commercial interest in the garden, where some profit could come from, and an opportunity to sell excess produce.	Potential Restaurants: Marco Polo Los Baez Alessandro's Bentley's

Figure 37 (continued): Making connections: organizations that could help establish or run community gardens in partnership with the Salem Housing Authority.

Compost

Compost is a way to recycle food scraps and yard debris while creating nutrient-rich material to add to potential gardens and landscaping areas. Additionally, creating a fun and interactive program to include kids and adults will enable a successful composting program and educate individuals on the natural processes of decomposition.

A number of schools have implemented composting into their classrooms, and we believe some of these plans would be congruent with the implementation of composting at Glen Creek and Orchard Village. It is necessary to have a few individuals willing to advocate for the program, lead construction, and monitor the bins as they develop. Possibilities for these leaders could include individuals living at Glen Creek or Orchard Village, or volunteers or interns from a local high school or college, and other gardeners in the community. More information on composting is provided in the Waste Management section.

Livestock

To increase food security as well as on-site food production, chickens could provide an excellent source of on-site protein. Salem recently passed Ordinance No. 19-10, stating that up to three hens per residence are allowed for urban homes. To keep chickens, one must apply for a license and abide by the laws of how to build a chicken coop. Having chickens on the property would be an excellent educational tool for the youth in learning how to care for and treat

animals. Providing farming opportunities for urban families has the potential to build community and create a deeper appreciation for stewardship. In addition, chickens reduce pests and provide manure to create richer compost for the garden.

There may be some resistance from residents concerning potential noise levels, but a coop at the southern end of the Glen Creek site would provide plenty of distance from the living complexes.

Goats are another option for the sites. Goats provide milk, cheese, and manure as well as help with lawn and landscaping maintenance. Goats are a great replacement for gasoline-powered lawn mowers.

Additional Benefits of Plants

Erosion Assistance

It was mentioned during the first Glen Creek visit that the housing development on the opposite side of the creek had disrupted the ground on the site and caused a number of trees to lose their roots and fall. Planting a series of native trees would stabilize the loose ground, help with irrigation, and decrease the amount of lawn maintenance. Similar erosion issues may be present on the Orchard Village site. Additionally, native shrubs and willows could be planted in

Japanese Garden (Salem's Sister City, Kawagoe, Japan)

Growing a Japanese garden along the southern edge of Glen Creek property promotes cultural awareness, and a connection with Salem's sister city, Kawagoe, Japan. The Japanese garden would be a glimpse into Japan, with designs that reflect key features in Japanese garden traditions (see Figures 38 and 39). Ideally, this area would serve as a retreat into nature, where residents can sit, removed from other aspects of their lives, and children can play away from the paved parking lot area. Additionally, it would give residents a connection to Japan that could be extended through further cultural extension programs. Local or state grants may be available to assist in the funding of such a garden.

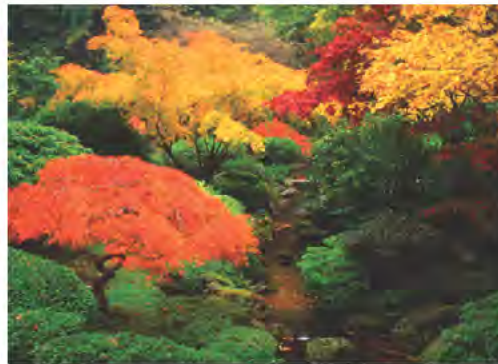

Figures 38 and 39: Japanese gardens.

parts of the floodplain on the east side of the site, which would help with irrigation and provide a natural habitat for birds, insects, other pollinators, and small mammals.

Sound Barrier

One of the concerns regarding the erection of a new building on the northeast side of the Glen Creek site is fear of complaints from residents of noise and disruption from the construction. Native trees planted on the northeast side of the property would create a natural noise barrier. If planted early enough, these plants would have time to grow and mature before another building is erected. Trees provide sound barriers for traffic noise as well.

Building Community

Education Components

We recommend incorporating an educational component to all the gardening and landscaping on both SHA sites. This allows residents to be aware of the produce available, and to be able to identify and use the various foods grown on site. We recommend detailed labeling in order for residents to identify plants, differentiate between what is edible and not edible, learn about the benefits of native species (environmental education), and provide examples of uses for the plants (especially helpful in the herb and vegetable gardens).

Outdoor Kitchen

An outdoor kitchen would help facilitate communal dinners, cooking classes, and Farm to School education. The amenities of the kitchen could be very simple, for example, a stone oven for cooking pizza. Community barbeques are currently set up on other public housing properties; the outdoor kitchen is an extension of this idea.

Involving the Homeless

SHA has set aggressive goals to eliminate homelessness in Salem; gardens on the Glen Creek and Orchard Village properties could help make this possible. Allowing individuals to gain gardening, cooking, and communication skills through volunteer opportunities at a garden site would provide them with skills to find a job and be able to support themselves. While it is recognized that the residents of the SHA sites may not want the garden or property opened up to homeless people, if a well-organized program is in place, homeless individuals could find themselves living in Salem public housing one day.

Phasing

- Distribute surveys to assess the amount of interest in gardening from residents and determine what crops residents would like to grow.
- Make connections with an organization that is willing to support on-site gardening.
- Have soil and gardening specialists visit to assess the area.

- Establish the garden plot and composting systems.
- Set up education resources, including an outside kitchen, ideally connecting with local restaurants to bring in cooking classes.
- Build a greenhouse and chicken coop.
- Write annual reports on garden progress, effects, and usage.

Finance

Initiating the Project

- Government grants: the USDA annually has many grants that could help fund these projects. Many focus on providing food security.

Nationwide grants: www.csrees.usda.gov/fo/funding.cfm

Statewide grants: www.oregon.gov/ODA/grants.shtml

- Connecting with the community garden in Orchard Heights Park for potential volunteers may help with breaking ground. There is a long waiting list for this garden, showing much interest within the West Salem area.
- Oregon Environmental Council has resources and sponsors that would help connect the Glen Creek Garden to the larger farming community. They also have information on how to ensure the garden is sustainable and efficient. This may be a good link to have local farmers come to the garden and assist in planning and support, as it is crucial to bring in expertise when breaking ground (www.oeconline.org 2010).

After a Garden is Established

- Encourage local restaurants to purchase produce and eggs from the farm.
- Provide an opportunity for youth residents to sell vegetables in the neighborhood (vegetable stand) creates a wider West Salem community and motivation for the youth to participate in gardening projects.
- Apply for garden support and attract a wide range of youth and community building activities by using the garden and outdoor kitchen. This provides an excellent opportunity to showcase community networking and food security within the SHA.

We recommend finding one organization, program, farm, or business that is committed to the upkeep of the farm in all phases and can assist the Glen Creek and Orchard Village community members in integrating the farm into their lives.

Proposal

Pivotal: Planting herb gardens and native plants, cultivating small-scale vegetable gardens, establishing an education component.

Progressive: Creating a larger-scale community garden; planting fruit trees and shade trees; constructing a greenhouse, composting system, and Japanese garden.

Pioneering: Raising livestock on the property, implementing social suggestions such as outdoor kitchen, homeless program, and a Farm to School program

Materials

Construction Materials

The selection of construction materials is a fundamental decision essential to the overall quality of a development site. This section will address the SHA's responsibility to the environment with new construction in deciding material use, as well as the ability to create an efficient and comfortable space for its residents.

Understanding the various components of materials is critical in deciding what to use for construction. Knowing how long a material typically lasts, when and how it is made, and where it originates, is important information when choosing material sources. The materials used in construction directly affect the building's efficiency, comfort, longevity, and environmental sustainability.

We recommend that the SHA seek out recycled, reused, or renewable products that perform at a level comparable to other traditional building materials, without the adverse effects on natural resources. By reusing supplies, the energy required to make these materials is effectively lessened by prolonging their lifespan. Materials that can be easily salvaged include heavy timber, glass, and bricks; these materials have a high energy cost to manufacture. Clever sourcing can also yield reusable finishing materials; everything from parquet flooring to building hardware can be reused from older buildings.

Material conservation is a direct effect of smart design. Most purchased cladding materials (e.g. drywall, plywood, metal sheeting, shingles) are typically manufactured four feet wide. If buildings are designed on four-foot modules, construction waste can be drastically minimized.

Affordable housing projects such as Glen Creek and Orchard Village offer a unique challenge in sustainable housing design, but not the first of their kind. Density is by nature a more efficient style of living, but it requires more consideration and collaboration.

Material Sources and Use

Material reduction, both by way of design and in construction, is an important part of sustainable building. Advanced framing with a twenty-four inch on-center gap between studs will save on structural lumber. Lumber should be the material of choice, because it can be locally harvested in Oregon. The heating and cooling industry adage is, "insulate before you insolate," meaning there is no use applying heat or cooling unless insulation is provided to prevent it from leaking out immediately. Careful consideration should be given to enclosure construction techniques. This includes installing insulation in the walls, floors, and roof, and installing energy-efficient windows.

To the extent that it is possible, construction materials should be sourced from local suppliers to cut down on monetary and environmental costs of transportation (embodied energy). Reused materials would be preferable, particularly bricks and/or cinderblocks to create interior thermal massing. A material to avoid as much as possible is asphalt. Often used in surface paving as well as in traditional roofing shingles, it is petroleum-based and non-recyclable.

Placing studs at 24” intervals rather than 16” intervals is effectively as strong as the traditional method, but can save 1/4 of the material.

Material Performance

Material quality depends strongly on the overall performance and lifespan of the product, therefore, Orchard Village should look for materials that will endure. Some of these materials include finishing products such as bamboo flooring and recycled-fiber carpets, while some are construction components including Forest Stewardship Council (FSC) certified lumber, recycled insulation, and double-glazed windows. Windows can especially contribute to both the quality of the finished product and quality of life for the residents.

In addition, a large-scale project with repetitive components lends itself to off-site construction. Particularly in a climate with as much rain as Oregon, any construction that can be done in an off-site warehouse by subcontractors would result in faster, higher-quality, and more predictable construction. Prefabricating certain components involves more people and greater coordination, but with the proper forethought, it often saves money.

Waste Management

Waste Management is defined as the management of any physical material that will be deemed as waste in the construction process and lifespan of the entire SHA Community. At the pivotal moment where a material has been deemed “waste,” the desire to discard it quickly to avoid sanitary, aesthetic, and personal discomfort concerns usually leads to suboptimal waste management. Landfills filled with municipal solid waste (MSW) are costly to maintain and initiate. Time Magazine announced in 2007 that the average person in the U.S. generated 1,643 lbs of trash in 2005 (Numbers 2007). In addition to the space and economic issues, landfills also contribute significantly to the off-gassing and distribution of some of the most toxic and detrimental pollutants.

The U.S. contributes 40% of the world’s waste even though it only occupies 5% of the world’s population (www.recycling-revolution.com 2010).

Reusable Materials

Reuse of materials can alleviate the demand for waste removal. We recommend an innovative program that provides residents with a small move-in package that includes items that enable reuse. For example, reusable tote bags, reusable water bottles, to-go coffee mugs, and reusable food containers for lunches would all provide opportunities for residents to limit their waste. Not only does a move-in package provide a warm, welcoming feeling for new residents, providing items that encourage waste reduction is a great educational tool.

Providing Recycling and Composting as Utilities

Recycling and the composting of organic materials are two effective alternatives to traditional waste disposal. Both options reduce the demand on landfills and provide other environmental and economic benefits as well. Recycling minimizes the need to extract and produce raw materials for new products. Composting can assist in the enrichment and remediating of soils, as well as preventing erosion and the pollution of stormwater runoff. The use of compost can also “reduce the need for water, fertilizers, and pesticides,” which makes it a “marketable commodity that is a low-cost alternative to standard landfill cover and artificial soil amendments” (www.epa.gov 2010).

Currently, Allied Waste Services is the waste service provider for the zone in Salem that includes Orchard Village (www.sanitation.com 2010). Allied Waste offers multiple options for waste removal, including recycling and food and lawn waste composting. Recycling can be incorporated into the service for no extra cost. Since recycling is free, adding it to the service contract can reduce the amount of MSW that the community produces, which in turn can reduce service costs. The addition of composting to the service does require small additional fees; however, they are minimal in comparison to that of the waste removal. For this reason, the use of composting as an alternative to standard MSW can also reduce the demand on waste costs and pickup.

In addition to providing these services to the community, it will be optimal for SHA to ensure residents are well educated on the rules and regulations associated with recycling and composting. Upon move-in, we suggest giving tenants a durable list of recyclable and compostable materials and directions on how to dispose of them. By providing basic information, there should be greater utilization of the service and less chance of contamination of recyclables with food products or non-recyclable materials. Community recycling and composting bins could be placed near trash containers and properly labeled and maintained, so they are easy to find and access for both tenants service providers.

Composting

Community Composting

The easier and more intriguing it is for each member of the community to use on-site composting, the greater the chance for successful MSW, cost, and energy reductions. Therefore, we recommend designing housing units with space designated for recycle, compost, and trash containers with the bins already in place. We also recommend space within the community grounds for composting that is both easily accessible and separated from areas where personal comfort and hygiene could be affected. Members of the community or on-site maintenance staff can potentially maintain this area. Compost bin cleaning stations could be located at key areas around the site. This would involve something as simple as a hose and drain, and would aid in the cleaning of personal compost bins and gardening tools. Another option is to provide a shed that contains gardening and composting supplies, which could be shared by the community through the use of a code lock.

Personal Composting

If SHA finds that interest in community composting is minimal, it may be more appropriate to provide small, personal outdoor composting bins to the interested tenants. Specific bins are easy to use and maintain, and reduce issues with unsightliness and odor. These can easily be stored on a patio or personal outdoor space associated with the unit. There are upfront costs associated with the purchase of composting bins, however, this upfront cost would be offset rather quickly in the cost savings due to the lower demand on MSW pickup. It would also be a one-time bulk cost, since bins can be reused and redistributed to future tenants.



Figure 40: Composting bins in a community garden.

Composting Toilets

To further assist in the reduction of waste, considerations should be given to issues of sewage. While there are seemingly many options for human waste removal, they are not without their environmental and economic problems. Traditional toilets often require large amounts of water, which can have a significant cost and simultaneously waste a valuable resource. In addition, sewage treatment facilities that currently deal with human waste are constantly under heavy loads, and any reduction to their demand is greatly valuable (Kwok 2007).

While it is not currently a conventional multi-family residential option, Orchard Village might benefit from the specification and utilization of advanced composting toilets with remote, continuous composting tanks. Even though this option requires a moderate degree of design analysis, upfront cost, and perhaps more routine maintenance than traditional sewage options, it has potential for payback. Money could be saved due to the reduction in sewage fees and water costs associated with traditional toilets. Continuous composting toilets require little to no water for use, and in some cases small amounts of energy. Another added economic benefit to the composting of human waste is that humus, a soil-like product used as fertilizer, is created through the breakdown (Kwok 2007). Humus can be collected and potentially sold to companies or independent parties for use on non-edible agricultural-crops; this sale could become a source of revenue for the Orchard Village Community, and for Glen Creek if a new building is constructed outfitted with composting toilets.

Proper maintenance will be one of the biggest concerns to the success of composting toilets. Instructions provided to tenants on the proper daily uses, limitations, and cleaning options associated with this unconventional system will be essential. However, if people are properly educated, they will find that having a composting toilet is almost the same as having a conventional toilet, with the main differences being in the cleaning and disposal of hygiene products. Maintenance of the composting tanks will generate the largest human demand (www.composting-toilet-store.com 2010). The compost does require turning, introduction of materials that are high in carbon (sawdust, straw, or bark), as well as emptying the humus (Kwok 2007). However, this type of maintenance is minimal based on load factors, sometimes as little as once or twice a year per tank. While this might be an added cost to the community, it will likely be offset by the cost savings and revenue generated by the system. Additionally, hiring a maintenance crew internally within the community can produce job opportunities.

Many projects and communities take advantage of composting toilet systems, and have made great efforts to advocate their success and gains. One community is the NutriCycle Systems Demonstration Site in Jefferson, Maryland (www.smartcommunities.ncat.org).

Proposal

Pivotal: Provide literature to all residents about recycling and composting; establish a shared recycling station for each development.

Progressive: Connect with local waste service providers to offer composting services in conjunction with providing all residents with small composting bins.

Pioneering: Establish an on-site composting facility for residents. Include composting toilets in new construction.

Resource Use and Social Interaction

As further exploration of the above suggestions continues, it will be useful to assess possible scenarios with an interdisciplinary approach. Not only will the development of a truly sustainable and green site be dependent on looking at green design, technology, and innovative solutions, but both developments should be designed with social justice, health, and residents' well-being in mind.

Creating a Community

Strong communities provide residents with a sense of enrichment, empowerment, and a desire to maintain the integrity of the site. If the SHA wants to provide innovative examples of environmental and social sustainability in the low-income housing sector, we recommend focusing on building the social infrastructure as much as the green building infrastructure.

Announcing and inviting the community to help construct the suggested projects can help spark community involvement, which could lead to decreased labor costs. Civic engagement is a necessity for the success of the projects defined. Because of the possible struggle with community activism in developments and programs, initiatives could be set up to help popularize a new way of living. Implementation of these strategies at the Glen Creek site can help provide the SHA with a good example of what could work at Orchard Village as well.

We recommend future teams consider:

- **Playgrounds:** Offer a safe place for families to congregate and children to play at the site and in the adjacent housing community.
- **Educational Center:** There will be a number of innovative design and building aspects as well as ecosystems present on the sites. This collection offers educational opportunities. Providing a person on site who can give tours, teach weekend classes, and answer general questions provides learning opportunities for the adults and children and the greater Salem community.
- **Community Center:** Children, parents, and single adults alike need a safe place to spend their nights and weekends. Developing an active community center on site where families can be together reduces the need to figure out how to get off site.
- **Community Clothes and Goods Exchange:** Useful goods exchanges occur across the country and enable families and neighborhoods to exchange items as they outgrow or no longer need things, while keeping reusable items out of landfills. This is especially useful and successful in communities with a large population of children.

Many schools have 'swapping weekends.' A successful exchange takes place typically before Christmas and the beginning of school (Monacelli 2010). An

exchange can be similar to a garage sale where a specific day or weekend is determined where the families gather to “trade.” However, some complexes have a small community space for individuals to place goods they no longer need or want. This is a location for families to either drop off used items or find items that may be useful to them.

Community Spaces

A main concern in the Glen Creek community is the amount of time kids play in the street rather than in the green spaces, play areas, and basketball court. The east side of the site is highly underutilized by the entire community, yet it has the potential to provide an area for children and adults to play, learn, explore, rest, and be active if designed properly.

Creative Sitting Areas

Glen Creek lacks a welcoming outdoor area – there are no benches or sitting areas – and both sites should strive to implement one. Benches provide a place for all individuals to have space to sit and enjoy being outside. If designed correctly, benches may also double as play areas.

Opportunities for original designs for these structures could be derived from students in the departments of Architecture or Art from the University of Oregon or Oregon State University, or from similar fields at local colleges and universities. It may also be possible to create a contest between the residents to design their own structure. Using these resources would cut down on design costs while providing unique pieces of functional art. Once a design is chosen, children from the developments may also play a role in the building of these pieces by helping to paint or helping to lay mosaic tiles. Students could provide creative designs that would be both inexpensive and unique to the area.

Pathways

We hope that by developing areas with garden beds, native species, sitting areas, and pathways, a welcoming space will be created to draw the children away from playing in the streets and lure the adults to the outdoors. With the proposed garden beds set on the east side of the Glen Creek site, we propose developing the area so that it is not only more accessible to residents, but more enjoyable as well.

Currently, there are two main paths connecting the inside of the Glen Creek complex. A proposed path between buildings 3 and 4, as well as a path from the parking lot of buildings 1 and 2 along the stream connecting to building 8, would create an increased walking interior. The latter path could feature a number of native species that have been planted and become a nature walk for families.

Outdoor Brick Oven and Picnic Area

We believe the addition of a barbecue or outdoor brick oven would be a welcoming space for friends and family to gather outside their living space. In addition, we suggest extending the current deck at Glen Creek around the east side of the building to create a more private area. An overhang could be added to cover part of the deck, which would allow the space to be both open and sheltered from the elements. Moreover, this open space would be welcoming for the used good exchanges during dry weather, as well as provide a space for educational meetings on gardening and other topics.

Most materials for the barbecue and overhang can be purchased at Salem building supply reuse stores, allowing close to 100 percent recycled materials. To construct the deck, we suggest materials such as Trex decking, which is typically more expensive but is weather- and insect-resistant, extremely durable, and has low maintenance costs.

The overhang can be constructed of 2x6 rafters, plywood, and shingles. The design of the overhang must include suitable gutters to keep the rain from flowing straight onto the deck. Gutters may also be attached to rain catchment systems, which would add to the proposed rainwater catchment system. Finally, the barbecue could have two separate grills, so that families can share the area. The interior of the barbecue pit would need to be made out of firebrick, and the exterior could be built with 8x4x16 Concrete Masonry Units.

Taking a Systems Approach

Each suggested idea alone has potential, but taken as a system, they hold real promise. Taking a systems approach will help to establish of a successful living place and a sense of community within both sites. A sense of community can improve the successful long-term viability of a housing complex and can create a sense of pride that leads to empowerment of its members. A community that is unified facilitates an involved attitude toward community concerns. Getting neighbors involved in the community fosters a viable barrier to issues such as crime and motivates people to help each other.

Conclusion

The Sustainable City Year program gives students a chance to put what they learn in the classroom into action. The SHA has an opportunity to draw from the creativity of students and be a leader in making a difference in public housing. The recommendations in this report would provide for sustainable growth in low-income housing, addressing the City of Salem's environmental, economic, and social health. While the Glen Creek and Orchard Village sites are small, localized communities, the example they will set has the potential to make a significant impact. The City of Salem has the opportunity with these sites to be on the cutting edge of addressing environmental conservation and community building through public housing.

While there are many strategies and recommendations that can be implemented within both developments, it is imperative that the needs of the residents are met through these upgrades. In order to meet these needs, focus should be placed on the input of the community, while promoting the aforementioned recommendations related to water, food, energy, resources, and transportation. Through these action items, a wealth of change can occur on the site, while incurring minimal net costs to SHA. These changes will foster a greater sense of community within the residents of Glen Creek and Orchard Village, giving them an opportunity to be part of a decision-making process that can improve their lives. These developments can become a model community for future SHA developments and for affordable housing communities throughout the region.

Appendix: Case Studies



CASE STUDIES

THESE CASE STUDIES ARE INCLUDED AS A REFERENCE SEE THE KEY BELOW FOR SPECIFIC INFORMATION PERTAINING TO MATERIALS, ENERGY, WATER, GOODS/SERVICES, WASTE, AND FINANCING.

A supplementary resource list is included at the end of the studies



Materials:
Pertains to sustainable sourcing & safety of construction materials and methods.



Energy/Heat:
Information regarding energy harvesting and distribution methods, both passive & active systems



Water:
Potable, storm & wastewater strategies.



Goods & Services:
Development pattern: included uses, transit, community involvement & industry.



Waste:
How has waste been reduced & behaviors changed?



Financing:
Addresses any pertinent collaborative financing efforts & strategies.



Hammarby Sjostad



wetlands & nature path



local transit



apartments & retention pond



recycling/waste system

Hammarby Sjostad - Sweden

Hammarby Sjostad is one of the best models of a development that promotes a comprehensive sustainability model. The development was the impetus for the development of the "Hammarby Model" an aggressive closed loop resource system.

Project Stats:

495 Acres

9,000 Units

Design Team: Jan Inghe-Hagstrom - Stockholm City Planning Bureau



Constructed on a remediated industrial site, Hammarby Sjostad demonstrates a honorable commitment to reuse during the construction stage; only sustainable, tested eco-friendly materials were used.



Buildings were planned to take advantage of passive heating cooling and ventilation but also utilize many more unique and advanced strategies. Half of resident energy is provided for within the development. This is done through the implementation of solar panels, the use of biogas in cooktops and a district heating plant that runs on sewage bio-fuel and household waste



All aspects of water treatment are considered. Storm-water is treated on-site through a network of swales, ponds, green-roofs and the lake. Lake water is collected and treated locally for drinking. Wastewater is broken down and used as bio-gas for cooktops, in the district heating plant, and as fertilizer.



Hammarby Sjostad is outside of Stockholm proper it is well connected by ferry, bus, subway, bike and walking paths and the development has a 25 vehicle car-share. The site also has several schools, shops restaurants, a church, many parks, a library and sports center.



The Hammarby Model(included in the report) is a comprehensive waste management strategy. It utilized wastewater, household waste, recyclables, food and hazardous waste in a well executed 'closed loop' model to reduce impact and provide municipal services to residents. It cannot be fully described here, please see the resource list for more information.



Project cost about \$ 2.25 billion.

It was primarily financed by the city of Stockholm and through partnerships with utilities providers and materials manufacturers.



Swales, sidewalk homes



street-side swales



retention pond



shared green spaces



community design input



community garden

High Point- Seattle, WA

The first residents moved into High Point in 2009. This HUD project in the west part of Seattle has been praised for its comprehensive stormwater management strategies, community design process, and the air quality of the homes in the neighborhood.

Project Stats:

120 acres

1,600 Units

Design Team: Mithun, Nakano Landscape Architects, SVR Engineering



The redevelopment salvaged many materials that had been used in the army barracks on the site previously. Some of these were used in new construction.

All new homes were constructed to high air quality standards to reduce the probability of youth asthma diagnoses. This included the use of low VOC (volatile organic compound) offgassing materials and both natural and active ventilation strategies



The major energy strategies employed are passive, taking advantage of passive ventilation and daylighting where possible.



The entire development is included in a comprehensive stormwater management strategy designed to reduce runoff into adjacent Longfellow Creek. There are more than four miles of grass and vegetated swales, and a drainage retention pond.



High Point is adjacent to bus lines on the Seattle Transit network, making it easy for residents to take advantage of public transit. Within the site there are many other amenities; a community center, library, medical and dental clinic, mixed use shopping center, and 'neighborhood house' designed to provide health, education, employment and family and social services to residents



A portion of demolition and construction waste was salvaged and recycling is encouraged.



The project cost \$550 million dollars and included the collective contributions of private investment, public funding, public borrowing & finance matching, and a HOPE VI grant.

Vauban - Freiburg, Germany



shared green-space



solar village



community building



identity through material



limited car access



adjacent to transit

Completed in 2006, Vauban in Freiburg, Germany is a model car-free development. Featuring an aggressive solar energy portfolio and a comprehensive transportation strategy Vauban demonstrates the positive results of community input & collaboration.

Project Stats:

98 Acres

5,000 People

Collaboration: Forum Vauban (community design collective) City of Freiburg.



Once the site of an army barracks Vauban recycled some buildings and materials. Homes and building were constructed to facilitate good air quality and achieve low-energy standards.



The district has a CHP Plant (combined heat & power,) utilizes passive resources (sun & wind) and an extensive network of solar collectors to provide energy. All buildings are constructed to meet the lowest energy standards, several are passive house or better rated.



80% of stormwater is treated locally and the neighborhood utilizes an 'ecological' sewage plant that harvests biogas from wastewater for use in homes.



Transit and community building are key principles in Vauban. Nearly half of residents live without personal vehicles. This is possible through proximity to public transit networks, car-share programs and bike purchasing assistance. The project contains mixed resident base; students, families, and professionals all of whom have stake in design and planning decisions for the entire neighborhood.



Waste and stormwater is treated locally. In addition recycling is encouraged.



Total Project cost \$702 million.

The financial collaboration on this project led not only to a diverse and interesting built environment but also lower costs, allowing greater accessibility to lower & middle income buyers.

Bibliography-Resources

High Point

http://mithun.com/projects/project_detail/high_point/
pdf: High Point-Case Study
<http://www.seattlehousing.org/redevelopment/high-point/>

High Point - *Re-Inventing Infrastructure from the gutter up*, Peg Stae-hell & Miranda Maupin, Arcade 2003.

Vauban

<http://www.vauban.de/info/abstract.html>
<http://www.cabe.org.uk/case-studies/vauban>
<http://www.madisonfreiburg.org/green/vauban.htm>

Hammarby Sjostad

<http://www.cabe.org.uk/case-studies/hammarby-sjostad>
<http://www.hammarbysjostad.se/>
<http://www.urbandesigncompendium.co.uk/hammarby%20sj%C3%B6stad>

The Hammarby Model.pdf - found on hammarbysjostad.se
Hammarby Sjostad- A unique environmental project in Stockholm.pdf
- Found on hammarbysjostad.se

Other Projects

Dockside Green - Victoria, British Columbia
Water treatment, Biogasifier Energy Generation

Prairie Crossing - IL, USA
Habitat preservation, local agriculture, community design

Millennium Waters - Vancouver BC
District heating plant, stormwater plans, net-zero building.

bedZED - London
Energy strategies, mixed uses

Bo01 - Malmo Sweden
Public spaces, innovation energy systems

Helensview - Portland, OR
Low-income, LEED-ND Project

Newington, Homebush Bay - Sydney, AUS
Financing for a solar neighborhood.

Additional Resources

Informational Resources

Salem Electric — Programs and Services brochure, Home Energy Use Guide
— <http://www.salemelectric.com/>

Home Energy Saver (Lawrence Berkeley National Laboratory) — <http://hes.lbl.gov/consumer/learn>

Energy Savers (US DOE, EERE) — <http://www.energysavers.gov/>

Alliance to Save Energy — <http://ase.org/>

Smart Communities Network — <http://www.smartcommunities.ncat.org/buildings/affhousing.shtml>

Energy Efficiency Factsheet (EnergyIdeas Clearinghouse) — www.energyideas.org/documents/factsheets/residresources.pdf

School to Farm Case study example: <http://thefoodproject.org/>

Contacts

Evolution Paving Resources

Scott Erickson

PO Box 20610

Salem, OR 97307

503-393-5050

Native Plants of the Northwest

2158 Bower Ct. S.E.

Salem, OR 97317

503-581-2638

Habitat for Humanity ReStore

1249 13th St. SE

Salem, OR 97302

References

Introduction

Salem Housing Authority (SHA)

US Census Bureau. Census 2000. SF3

Transportation

Raphael, Steven and Michael A Soll. "Can Boosting Minority Car-Ownership Rates Narrow Inter-Racial Employment Gaps?" Brookings-Wharton Papers on Urban Affairs: 2001, p99-145.

Salem-Keizer Area Transportation Study

Salem-Keizer Area Transportation Plan

"How Walk Score Works." Get Your Walk Score - A Walkability Score For Any Address. Web. Oct.-Nov. 2010. <<http://www.walkscore.com/how-it-works.shtml>>.

"Schedules and Maps." Cherriots | Salem-Keizer Transit. Salem-Keizer Transit. Web. Oct.-Nov. 2010. <<http://www.cherriots.org/>>.

www.walkscore.com/score/1300-Orchard-Heights-Rd.-NW-Salem-Oregon-97304

Yago, Glenn. "The Sociology of Transportation." 1983.

Car Sharing, an Alternative to Car Rental and Car Ownership – Zipcar. Zipcar Inc. Web. Oct.-Nov. 2010. <<http://www.zipcar.com/>>.

Environmental Protection Agency, "Greenhouse Gas Emissions from the US Transportation Sector 1990 2003." March 2006.

Frank, L., et al., 2006 Many pathways from land use to health: Associations between neighborhood walkability and active transportation, body mass index, and air quality, *Journal of the American Planning Association*, 72, 75-87

Dunn, A., et al., 1999 Comparison of lifestyle and structured interventions to increase physical activity and cardiorespiratory fitness: a randomized trial, *JAMA*, 281, 327-34

Energy

Alliance to Save Energy. "Improving Energy Performance in Low-Income Housing," March 2006. www.efficientwindows.org.

- Brown, G. Z., and M. Dekay. Sun, Wind, and Light. 2nd ed. New York, NY: John Wiley and Sons, Inc., 2001.
- Brown, G.Z., T. Sekiguchi, and J. Kline. Energy Scheming 3.2, 2008.
- Community HousingWorks. "SOLARA," 2010. http://www.chworks.org/affordable_housing/solara.asp.
- Friedrich, K., J. Amann, S. Vaidyanathan, and R. N. Elliott. Visible and Concrete Savings: Case Studies of Effective Behavioral Approaches to Improving Customer Energy Efficiency. ACEEE, (2010).
- Geller, E. S, J. B Erickson, and B. A Buttram. "Attempts to promote residential water conservation with educational, behavioral and engineering strategies." Population & Environment 6, no. 2 (1983): 96–112.
- Global Green USA. "Green Affordable Housing: Los Vecinos," 2010. <http://www.globalgreen.org/greenurbanism/affordablehousing/projects/12>.
- Lawrence Berkeley National Laboratory. "Home Energy Saver," 2010. <http://hes.lbl.gov/consumer/learn>.
- Lopez Community Land Trust. "Common Ground," 2010. <http://www.lopezclt.org/common-ground/>.
- Lutzenhiser, L. "Social and behavioral aspects of energy use." Annual Review of Energy and the Environment 18, no. 1 (1993): 247–289.
- McPherson, E. Gregory. "Evaluating the cost effectiveness of shade trees for demand-side management." The Electricity Journal 6, no. 9 (November 1993): 57-65.
- Mithun, Inc. "Net-Zero Energy Affordable Neighborhood Opens on Lopez Island," 2010. http://mithun.com/press/release/net-zero_energy_affordable_neighborhood_opens_on_lopez_island/.
- Petersen, John E., Vladislav Shunturov, Kathryn Janda, Gavin Platt, and Kate Weinberger. "Dormitory residents reduce electricity consumption when exposed to real-time visual feedback and incentives." International Journal of Sustainability in Higher Education 8, no. 1 (2007): 16-33.
- Salem Electric. "Programs and Services Brochure," n.d.
- Salem Electric. Phone conversation. Nov. 23, 2010
- Utz, Nicole. Email correspondence. Nov. 16, 2010.
- www.portal.hud.gov/portal/page/portal/HUD/recovery/programs/green
- "Energy Savers: Demand (Tankless or Instantaneous) Water Heaters." EERE: Energy Savers Home Page. U.S. Department of Energy, 09 Feb. 2011. Web. 13 Mar. 2011. <http://www.energysavers.gov/your_home/water_heating/index.cfm/mytopic=12820>.

- Kwok, Alison, and Walter Grondzik. *The Green Studio Handbook: Environmental Strategies for Schematic Design*. Burlington, MA: Architectural Press, 2007. 249. Print.
- Svejkovsky, Cathlene, and Tracy Mumma. "Smart Communities Network: Green Buildings Success Stories." *Smart Communities Network - Creating Energy Smart Communities*. Ed. Jeff Birkby. Trans. Megan Schuknecht. National Center for Appropriate Technology. Web. Oct.-Nov. 2010. <http://www.smartcommunities.ncat.org/success/hanson_assoc.shtml>.
- WBDG - The Whole Building Design Guide. National Institute of Building Sciences. Web. Oct.-Nov. 2010. <<http://www.wbdg.org/>>.
- "Functioning Principles of a Biomass Combined Heat and Power (CHP) Station | Agentur Für Erneuerbare Energien." *Startseite | Agentur Für Erneuerbare Energien*. Web. 8 Feb. 2011. <<http://www.unendlich-viel-energie.de/en/heat/details/article/172/functioning-principles-of-a-biomass-combined-heat-and-power-chp-station.html>>.
- "KnowledgePublications - Learning a Little More Every Day." *Books on Solar, Hydrogen, Fuel Cell, Wind Energy, Biomass Energy, All DIY and How To and More..* Web. 8 Feb. 2011. <http://www.knowledgepublications.com/doe/doe_fuel_cell_handbook_hydrogen_power_generation.htm>.
- "Energy Savers: Indirect Gain (Trombe Walls)." *EERE: Energy Savers Home Page*. U.S. Department of Energy. Web. 08 Feb. 2011. <http://www.energysavers.gov/your_home/designing_remodeling/index.cfm/mytopic=10300>.
- "Passive Solar Home Design." *Home :: MontanaGreenPower.com*. National Center for Appropriate Technology. Web. 8 Feb. 2011. <http://www.montanagreenpower.com/faq/passive_solar_design.php>.
- "Halle 58 Architekten, Bern, Switzerland, Architects." *Contemporan*. Web. 8 Feb. 2011. <<http://www.contemporan.com/company/halle-58-architekten/>>.
- Hlaváček, Dalibor. "Projekty — Green Lab." *Obytný Soubor Lodenareal*. Web. 8 Feb. 2011. <<http://www.greenlab.cz/cs/projekty/obytny-soubor-lodenareal/>>.

Water

- Dunn, Alexandra Dapolito, "Siting Green Infrastructure: Legal and Policy Solutions to Alleviate Urban Poverty and Promote Healthy Communities" (2010). *Pace Law Faculty Publications*. Paper 559. <http://digitalcommons.pace.edu/lawfaculty/559>. Web.
- Geller, E. Scott, Jeff B. Erickson and Brenda A. Buttram. "Attempts to Promote Residential Water Conservation with Educational, Behavioral and Engineering Strategies." *Population and Environment*, 6.2 (1983): 96-112. JSTOR. Web.

Kwok, Alison, and Walter Grondzik. *The Green Studio Handbook: Environmental Strategies for Schematic Design*. Burlington, MA: Architectural Press, 2007.

Lens, Piet N.L. *Decentralized Sanitation and Reuse: Concepts, Systems and Implementation*. London: IWA Publ., 2001. 174-238. Print.

Waterfall, Patricia H. "Harvesting Rainwater for Landscape Use." University of Arizona Cooperative Extension, Tucson, AZ. 1998. Web.

Vollum, Jean. Personal Interview November 2010.

Agriculture

Hansen, Wallace. "Native Plant Nursery & Gardens." Wallace W Hansen Native Plants of the Northwest. 2010. Web. 26 Dec. 2010. <<http://www.nwplants.com/>>.

Hill, Holly. "Food Miles: Background and Marketing." ATTRA. NCAT, 23 June 2010. Web. 27 Nov. 2010. <<http://www.attra.ncat.org/attra-pub/foodmiles.html>>.

"Marion-Polk Foodshare Garden Locations." Google Maps. Web. 18 Nov. 2010. <http://maps.google.com/maps/ms?hl=en&ie=UTF8&source=embed&msa=33&msid=117847324139325243618.000480c41845daae9b7d0&abauth=4ce4b394YANBwO_QjOdHDmhaSN3m6xuxzhw>.

Parker, Paige. "Mobile Farmer's Market Pulls up to Cully OregonLive.com." Oregon Local News, Breaking News, Sports & Weather - OregonLive.com. 4 Sept. 2009. Web. 28 Nov. 2010. <http://www.oregonlive.com/news/index.ssf/2009/09/mobile_farmers_market_pulls_up.html>.

"Oregon's Statewide Planning Goals & Guidelines." Oregon.gov Home Page. Web. 18 Nov. 2010. <<http://www.oregon.gov/>>.

"Salem, Oregon Average Temperatures." Salem Oregon Community Guide. Web. 18 Nov. 2010. <http://www.oregonlink.com/salem_averages.html>.

Symington, Paul. "High Point Community Garden." Wikimedia Commons. Web. 8 Feb. 2011. <http://commons.wikimedia.org/wiki/File:High_Point_community_garden.jpg>.

Resource Use and Social Interaction

Monacelli, Nikki. "Useful Goods Exchange « Sunnyside Family Swap Shop and Play Space." Useful Goods Exchange. 18 Apr. 2010. Web. 20 Nov. 2010. <<http://www.sunnysideswapshop.org/wp/events/useful-goods-exchange/>>.

Materials

"Recycling Facts." A Recycling Revolution. Web. Oct.-Nov. 2010. <<http://www.recycling-revolution.com/recycling-facts.html>>.

Allied Waste Services of Albany-Lebanon. Web. Oct.-Nov. 2010. <http://www.sanitation.com/Pages/Home_St.aspx>.

Knecht, Barbara. Designing for Disassembly and Deconstruction. *Architectural Record*, Oct. 2004. Vol. 192 Issue 10, p. 181-188

“Environmental Benefits | Composting | US EPA.” US Environmental Protection Agency. 07 Oct. 2008. Web. Oct.-Nov. 2010. <<http://www.epa.gov/osw/conserves/rrr/composting/benefits.htm>>.

“Composting Toilet Store | Frequently Asked Questions Page.” Composting Toilet Store | Free Shipping! Home Products ‘N’ More Store. Web. Oct.-Nov. 2010. <http://www.composting-toilet-store.com/Composting_Toilet_FAQ_s/32.htm>.

Rik G.M. Pieters, Changing Garbage Disposal Patterns of Consumers: Motivation, Ability, and Performance. *Journal and Public Policy & Marketing*.

Numbers. *Time*, 6/25/2007, vol. 169 issue 26. p. 14

Annie&John. “Urban Ag Day 2009.” Flickr - Photo Sharing. 11 July 2009. Web. 8 Feb. 2011. <<http://www.flickr.com/photos/annie-john/3715097378/>>.