

Multifamily Housing Design Project

We've taken a second look at our multifamily housing design standards.

The Multifamily Housing Design project intended to update Salem's design standards for multifamily housing, which is development with three or more dwelling units. The project aimed to help meet our community's housing needs by removing barriers to the development of multifamily housing and ensuring that new development is compatible with our neighborhoods.

To accomplish this, the project resulted in a proposed code amendment that:

- Provides greater flexibility in how multifamily design standards can be met
- Creates new design standards for small multifamily housing projects

Currently, there are more than 60 multifamily design standards. They regulate open space, landscaping, parking design, site access, building mass, facade design, recycling, and more.

Here are highlights of the proposed changes:

The complete list of proposed changes can be found after the chart below.

Topic	Current	Proposed
3- and 4-unit Development	<ul style="list-style-type: none"> • Considered "multiple family development" • Must meet the same 60+ design standards as very large multifamily developments 	<ul style="list-style-type: none"> • Excluded from the definition of "multiple family development" • Must generally meet the same standards as single-family homes (e.g., maximum height of 35 ft, rear setback of 14 ft or 20 ft in the multiple family zones) • Must meet minimal design standards (e.g., building entrance faces a street or common open space, roof is pitched, etc.)
5 to 12-unit Development	<ul style="list-style-type: none"> • Considered "multiple family development" • Must meet the same 60+ design standards as very large multifamily developments 	<ul style="list-style-type: none"> • Must meet limited design standards such as: <ul style="list-style-type: none"> - A primary entrance faces the street - No parking between buildings and streets - 20% of site is common open space - Pedestrian connections to sidewalks, common open spaces, and parking - Reduced setbacks for smaller buildings



Multifamily Housing Design Project

Topic	Current	Proposed
13+ unit Development: <i>Open Space</i>	<ul style="list-style-type: none"> 30% of the site must be common open space <ul style="list-style-type: none"> Up to 50% can be in setbacks Up to 30% can be indoor or covered At least one common open space must be of a minimum size (<i>proposed to remain</i>) Private open space (e.g., balconies, patio) must be provided for every unit Projects with 20+ units must provide a play or recreation area 	<ul style="list-style-type: none"> At least 30% of the site must be a mix of common or private open space <ul style="list-style-type: none"> Can be indoor, covered, and in setbacks Requirement can be reduced by 50% if within ¼ mile walking distance of a public park Square footage of a play or recreation area is counted twice toward the requirement Project with 20+ units must provide at least 20% of units with private open space
13+ unit Development: <i>Setbacks and Compatibility</i>	<ul style="list-style-type: none"> Buildings next to single-family zones must be set back 1 ft for every 1 ft of building height, with minimums (<i>proposed to remain</i>): <ul style="list-style-type: none"> 1-story: 14 ft setback 2 or more-story: 20 ft setback Setbacks must be landscaped and have a 6-ft tall fence or wall (<i>proposed to remain</i>) 	<ul style="list-style-type: none"> 5-ft reduction in setback allowed if an 8-ft tall fence is provided No balconies overlooking properties zoned single family
13+ unit Development: <i>Building Mass and Articulation</i>	<ul style="list-style-type: none"> Every two attached units must be offset from the next unit by at least 4 feet Buildings cannot be more than 150 ft long (<i>proposed to remain</i>) Common entrances can serve up to 4 units (<i>proposed to remain</i>) Rooflines cannot exceed 100 ft without a 4-ft change in elevation 	<ul style="list-style-type: none"> The vertical face of long buildings must incorporate design elements such as covered decks, offsets, or covered balconies Rooflines cannot exceed 100 ft without a 4-ft change in elevation <i>or cross gable</i> Base of multi-story buildings must be distinguished through color, material, or molding
Parking	<ul style="list-style-type: none"> 3 units: 2 spaces per unit 4+ units: 1.5 spaces per unit 	<ul style="list-style-type: none"> 3-12 units: 1 space per unit 13+ units: Based on bedroom size of unit <ul style="list-style-type: none"> Studio or 1-bedroom: 1 space per unit 2+ bedrooms: 1.5 spaces per unit Allow up to 25% parking reduction for transit access, on-site car share, or more covered bike parking Allow parking reduction for affordable housing
Review Process	<ul style="list-style-type: none"> Project meets all standards: Staff review with no public notice (<i>proposed to remain</i>) Project <i>cannot</i> meet all standards: Public hearing with public notice 	<ul style="list-style-type: none"> Project <i>cannot</i> meet all standards: <ul style="list-style-type: none"> Apply for an adjustment to specific standards (<i>public notice/comment and staff review</i>) Adjustment decisions can be appealed to the hearing officer City Council can call up decisions that have been appealed (<i>Class 2 adjustments</i>)

Learn more or provide input

- Contact:** Eunice Kim, Planner III, ekim@cityofsalem.net or 503-540-2308
- Visit the project page:** www.cityofsalem.net/Pages/updating-multifamily-housing-design-requirements.aspx

Sec. 112.015. - Dwelling unit density.

The number of dwelling units permitted on property shall be calculated by dividing the lot area in square feet by 43,560 and multiplying that figure by the minimum or maximum density allowed. ~~Any fractional number shall be rounded to the next highest whole number.~~ Any computation that yields a fraction of less than 0.5 shall be rounded down to the nearest whole number and any computation that yields a fraction of 0.5 or greater shall be rounded up to the next nearest whole number.

Sec. 250.005. - Adjustments.

(a) *Applicability.*

(1) *Classes.*

- (A) A Class 1 adjustment is an adjustment to any numerical development standard in the UDC that increases or decreases the standard by not more than 20 percent.
- (B) A Class 2 adjustment is an adjustment to any development standard in the UDC other than a Class 1 adjustment, including an adjustment to any numerical development standard in the UDC that increases or decreases the standard by more than 20 percent.

(2) *Prohibition.* Notwithstanding subsection (a)(1) of this section, an adjustment shall not be granted to:

- (A) Allow a use or activity not allowed under the UDC;
- (B) Change the status of a use or activity under the UDC;
- (C) Modify a definition or use classification;
- (D) Modify a use standard;
- (E) Modify the applicability of any requirement under the UDC;
- (F) Modify a development standard specifically identified as non-adjustable;
- (G) Modify a development standard that contains the word "prohibited";
- (H) Modify a procedural requirement under the UDC;
- (I) Modify a condition of approval placed on property through a previous planning action;
- (J) A design review guideline or design review standard, except Multiple Family Design Review Standards in SRC Chapter 702, which may be adjusted; or
- (K) The required landscaping in the Industrial Business Campus (IBC) Zone.

(b) *Procedure type.* Class 1 and Class 2 adjustments are processed as a Type II Procedure under SRC chapter 300.

(c) *Submittal requirements.* In addition to the submittal requirements for a Type II application under SRC chapter 300, an application for a Class 1 or Class 2 adjustment shall include the following:

- (1) A site plan, of a size and form and in the number of copies meeting the standards established by the Planning Administrator, containing all information necessary to

establish satisfaction with the approval criteria. By way of example, but not of limitation, such information may include the following:

- (A) The total site area, dimensions, and orientation relative to north;
 - (B) The location of all proposed primary and accessory structures and other improvements, including fences, walls, and driveway locations, indicating distance to such structures from all property lines and adjacent on-site structures;
 - (C) All proposed landscape areas on the site, with an indication of square footage and as a percentage of site area;
 - (D) The location, height, and material of fences, berms, walls, and other proposed screening as they relate to landscaping and screening required by SRC chapter 807;
 - (E) The location of all trees and vegetation required to be protected pursuant to SRC chapter 808; and
 - (F) Identification of vehicle, pedestrian, and bicycle parking and circulation areas, including handicapped parking stalls, disembarking areas, accessible routes of travel, and proposed ramps.
- (2) An existing conditions plan, of a size and form and in the number of copies meeting the standards established by the Planning Administrator, containing the following information:
- (A) The total site area, dimensions, and orientation relative to north;
 - (B) The location of existing structures and other improvements on the site, including accessory structures, fences, walls, and driveways, noting their distance from property lines;
 - (C) The location of the 100-year floodplain, if applicable; and
 - (D) The location of drainage patterns and drainage courses, if applicable.

(d) *Criteria.*

- (1) An application for a Class 1 adjustment shall be granted if all of the following criteria are met:
- (A) The purpose underlying the specific development standard proposed for adjustment is:
 - (i) Clearly inapplicable to the proposed development; or
 - (ii) Clearly satisfied by the proposed development.
 - (B) The proposed adjustment will not unreasonably impact surrounding existing or potential uses or development.
- (2) An application for a Class 2 adjustment shall be granted if all of the following criteria are met:
- (A) The purpose underlying the specific development standard proposed for adjustment is:
 - (i) Clearly inapplicable to the proposed development; or
 - (ii) Equally or better met by the proposed development.

- (B) If located within a residential zone, the proposed development will not detract from the livability or appearance of the residential area.
 - (C) If more than one adjustment has been requested, the cumulative effect of all the adjustments result in a project which is still consistent with the overall purpose of the zone.
- (e) *Transfer of adjustments.* Unless otherwise provided in the final decision granting the adjustment, an adjustment shall run with the land.

Sec. 400.005. - Organization.

The organizational framework for the classification of uses under this chapter is described in Table 400-1.

TABLE 400-1. ORGANIZATION OF USES			
Classification	Category	Use	
Residential	Household Living	Single family	
		Two family	
		Three family	
		Four family	
		Multiple family	
	Group Living	Room and board	
		Residential care	
		Nursing care	
Commercial	Lodging	Short-term commercial lodging	
		Long-term commercial lodging	
		Nonprofit shelters	
	Retail Sales and Service	Eating and drinking establishments	
		Retail sales	
		Personal services	
		Postal services and retail financial services	
	Business and Professional Services	Office	
		Audio/visual media production	
		Laboratory research and testing	
			Motor vehicle and manufactured dwelling and trailer sales

	Motor Vehicle, Trailer, and Manufactured Dwelling Sales and Services	Motor vehicle services
		Commercial parking
		Park-and-ride facilities
		Taxicabs and car services
		Heavy vehicle and trailer sales
		Heavy vehicle and trailer service and storage
Public Services	Recreation, Entertainment, and Cultural Services and Facilities	Commercial entertainment—indoor
		Commercial entertainment—outdoor
		Major event entertainment
		Recreational and cultural community services
		Parks and open space
		Nonprofit membership assembly
		Religious assembly
	Health Services	Medical centers/hospitals
		Outpatient medical services and laboratories
	Education Services	Day care
		Basic education
		Post-secondary and adult education
	Civic Services	Governmental services
		Social services
		Governmental maintenance services and construction
	Public Safety	Emergency services
		Detention facilities
		Military installations
	Funeral and Related Services	Cemeteries
		Funeral and cremation services
Industrial	Construction Contracting, Repair, Maintenance, and Industrial Services	General repair services
		Building and grounds services and construction contracting

		Cleaning plants
		Industrial services
	Wholesale Sales, Storage, and Distribution	General wholesaling
		Heavy wholesaling
		Warehousing and distribution
		Self-service storage
	Manufacturing	General manufacturing
		Heavy manufacturing
		Printing
	Infrastructure and Utilities	Transportation Facilities
Passenger ground transportation facilities		
Marine facilities		
Utilities		Basic utilities
		Wireless communication facilities
		Drinking water treatment facilities
		Power generation facilities
		Data center facilities
		Fuel dealers
		Waste-related facilities
Natural Resources	Mining and Natural Resource Extraction	Petroleum and natural gas production
		Surface mining
	Farming, Forestry, and Animal Services	Agriculture
		Forestry
		Agriculture and forestry services
		Keeping of livestock and other animals
		Animal services

Sec. 400.030. - Household living.

Household living consists of the residential occupancy of an owner-occupied or rented dwelling unit on a wholly or primarily non-transient, long-term basis, typically 30 days or more, by a family.

(a) *Single family.*

- (1) *Characteristics.* ~~Single family is characterized by the r~~Residential occupancy of a single dwelling unit on an individual lot or space by a family. Single family dwelling units can be detached, attached at the common side lot line, or built contiguous with one side lot line.
- (2) *Examples.* Single family detached dwelling; zero side yard dwelling; townhouse; manufactured dwelling; manufactured dwelling park; residential home, as defined under ORS 197.660; secondary dwelling.
- (b) *Two family.*
- (1) *Characteristics.* ~~Two family is characterized by the r~~Residential occupancy of two dwelling units on an individual lot by two families.
- (2) *Examples.* Duplex; two family shared dwelling; two dwellings units on one lot.
- (3) *Exceptions.* An accessory dwelling unit on the same lot as a single-family detached dwelling unit, manufactured home, or zero side yard dwelling. An accessory dwelling unit is an accessory use to a single-family detached dwelling, manufactured home, or zero side yard dwelling.
- (c) *Three family.*
- (1) *Characteristics.* Residential occupancy of three dwelling units on an individual lot by three families.
- (2) *Examples.* Triplex; three dwellings units on one lot.
- (d) *Four family.*
- (1) *Characteristics.* Residential occupancy of four dwelling units on an individual lot by four families.
- (2) *Examples.* Quadplex; four dwellings units on one lot.
- (e)(e) *Multiple family.*
- (1) *Characteristics.* ~~Multiple family is characterized by the r~~Residential occupancy of three or more dwelling units on an individual lot by three or more families.
- (2) *Examples.* Apartments; court apartments; three or more dwelling units on one lot.

Sec. 510.005. - Uses.

- (a) Except as otherwise provided in this section, the permitted (P), special (S), conditional (C), and prohibited (N) uses in the RA zone are set forth in Table 510-1.

TABLE 510-1. USES		
Use	Status	Limitations & Qualifications
Household Living		
Single family	P	The following single family activities: <ul style="list-style-type: none"> ■ Single family detached dwelling. ■ Residential home, as defined under ORS 197.660. ■ Manufactured dwelling park, subject to SRC chapter 235.

	S	The following single family activities: <ul style="list-style-type: none"> ■ Manufactured home, subject to SRC 700.025. ■ Townhouse, subject to SRC 700.085. ■ Zero side yard dwelling, subject to SRC 700.095.
	N	All other single family.
Two family	P	The following two family activities: <ul style="list-style-type: none"> ■ Duplex, when located on a corner lot. ■ Duplex, when located on a lot whose side abuts property other than a street or alley in a Commercial (C) or Industrial (I) Zone, and the entire lot is located within 165 feet of the C or I zone.
	S	Two family shared dwelling, subject to SRC 700.090.
	N	All other two family.
<u>Three family</u>	<u>N</u>	
<u>Four family</u>	<u>N</u>	
Multiple family	N	
Group Living		
Room and board	N	
Residential care	C	Residential facility, as defined under ORS 197.660, when located on a lot with frontage on an arterial or collector street.
	N	All other residential care.
Nursing care	C	Nursing care, when located on a lot with frontage on an arterial or collector street.
	N	All other nursing care.
Lodging		
Short-term commercial lodging	C	Short-term rentals.
	N	All other short-term commercial lodging.
Long-term commercial lodging	N	
Nonprofit shelters	C	Nonprofit shelters serving 5 or fewer persons, when located on a lot with frontage on an arterial or collector street.
	P	Nonprofit shelters serving victims of domestic violence for 10 or fewer persons.
	N	All other nonprofit shelters.

Retail Sales and Service		
Eating and drinking establishments	N	
Retail sales	P	Retail sales of agricultural products, when the sales area does not exceed 1,000 square feet in size.
	N	All other retail sales.
Personal services	C	The following personal services activities: <ul style="list-style-type: none"> ■ Beauty salons. ■ Barber shops.
	N	All other personal services.
Postal services and retail financial services	N	
Business and Professional Services		
Office	C	Landscape architects and planners.
	N	All other office.
Audio/visual media production	N	
Laboratory research and testing	N	
Motor Vehicle, Trailer, and Manufactured Dwelling Sales and Services		
Motor vehicle and manufactured dwelling and trailer sales	N	
Motor vehicle services	N	
Commercial parking	N	Parking structures.
	S	All other commercial parking, subject to SRC 700.050.
Park-and-ride facilities	N	
Taxicabs and car services	N	
Heavy vehicle and trailer sales	N	
Heavy vehicle and trailer service and storage	N	
Recreation, Entertainment, and Cultural Services and Facilities		

Commercial entertainment—indoor	N	
Commercial entertainment—outdoor	S	Golf courses, subject to SRC 700.015.
	N	All other commercial entertainment—outdoor.
Major event entertainment	N	
Recreational and cultural community services	P	Libraries.
	S	Golf courses, subject to SRC 700.015.
	C	All other recreational and cultural community services.
Parks and open space	C	Arboreta and botanical gardens.
	P	All other parks and open space.
Nonprofit membership assembly	C	
Religious assembly	S	Religious assembly, subject to SRC 700.055.
Health Services		
Medical centers/hospitals	N	
Outpatient medical services and laboratories	N	
Educational Services		
Day care	P	The following day care activities: ■ Child day care home. ■ Adult day care home.
	C	The following day care activities: ■ Child day care center. ■ Adult day care center.
	N	All other day care.
Basic education	S	Basic education, subject to SRC 700.010.
Post-secondary and adult education	N	
Civic Services		
Governmental services	N	
Social services	S	Social services, subject to SRC 700.080.

Governmental maintenance services and construction	N	
Public Safety		
Emergency services	N	The following emergency services activities: <ul style="list-style-type: none"> ■ Ambulance stations. ■ Ambulance service facilities.
	P	All other emergency services.
Detention facilities	N	
Military installations	N	
Funeral and Related Services		
Cemeteries	N	
Funeral and cremation services	N	Crematories.
	C	All other funeral and cremation services.
Construction Contracting, Repair, Maintenance, and Industrial Services		
General repair services	N	
Building and grounds services and construction contracting	C	The following building and grounds services and construction contracting activities: <ul style="list-style-type: none"> ■ Landscape, lawn, and garden services. ■ Tree and shrub services.
	N	All other building and grounds services and construction contracting.
Cleaning plants	N	
Industrial services	N	
Wholesale Sales, Storage, and Distribution		
General wholesaling	N	
Heavy wholesaling	N	
Warehousing and distribution	N	
Self-service storage	N	
Manufacturing		
General manufacturing	N	
Heavy manufacturing	N	
Printing	N	

Transportation Facilities		
Aviation facilities	N	
Passenger ground transportation facilities	P	Transit stop shelters.
	N	All other passenger ground transportation facilities.
Marine facilities	N	
Utilities		
Basic utilities	P	
Wireless communication facilities	Allowed	Wireless communication facilities are allowed, subject to SRC chapter 703.
Drinking water treatment facilities	C	
Power generation facilities	N	
Data center facilities	N	
Fuel dealers	N	
Waste-related facilities	N	
Mining and Natural Resource Extraction		
Petroleum and natural gas production	N	
Surface mining	N	
Farming, Forestry, and Animal Services		
Agriculture	N	Marijuana production.
Forestry	P	All other agriculture.
Agriculture and forestry services	N	
Keeping of livestock and other animals	P	Raising of livestock, fowl, and other animals by residents of the premises for their own private noncommercial use on a lot 10,000 square feet or greater.
	C	All other keeping of livestock and other animals.
Animal services	S	Small animal veterinary services, subject to SRC 700.075.
	C	All other animals services.
Other Uses		

Accessory short-term rentals	S	Accessory short-term rental, subject to SRC 700.006.
Temporary uses	P	The following temporary uses: <ul style="list-style-type: none"> ■ Christmas tree sales, subject to SRC 701.015. ■ Residential sales/development office, subject to SRC 701.030. ■ Replacement single family dwelling, subject to SRC 701.025.
Home occupations	S	Home occupations, subject to SRC 700.020.
Guest houses and guest quarters	P	Guest houses and guest quarters are permitted as an accessory use to single family, provided such houses and quarters are dependent upon the main building for either kitchen or bathroom facilities, or both, and are used for temporary lodging and not as a place of residence.
Taking of boarders or leasing of rooms by resident family	P	Taking of boarders or leasing of rooms by a resident family is permitted as an accessory use to household living, provided the total number of boarders and roomers does not exceed 2 in any dwelling unit.
Storage of commercial vehicle as an accessory use to household living	P	Storage of a commercial vehicle as an accessory use to household living is permitted, provided no more than 1 commercial vehicle is stored per dwelling unit.
Historic resource adaptive reuse pursuant to SRC chapter 230	Allowed	Historic resource adaptive reuse pursuant to SRC chapter 230 is allowed, subject to SRC 230.085.
Accessory dwelling units	S	Accessory dwelling units, subject to SRC 700.007.

(b) Continued uses. Existing cottage housing within the RA zone constructed prior to May 15, 1979, but which would otherwise be made non-conforming by this chapter, is hereby deemed a continued use.

- (1) Building or structures housing a continued use may be structurally altered or enlarged, or rebuilt following damage or destruction, provided such alteration, enlargement, or rebuilding complies with the standards set forth in SRC 510.010(e).
- (2) Cease of occupancy of a building or structure for a continued use shall not preclude future use of the building or structure for that use; provided, however, conversion of the building or structure to another use shall thereafter prevent conversion back to that use.

Sec. 511.005. - Uses.

(a) Except as otherwise provided in this section, the permitted (P), special (S), conditional (C), and prohibited (N) uses in the RS zone are set forth in Table 511-1.

TABLE 511-1. USES

Use	Status	Limitations & Qualifications
Household Living		
Single family	P	The following single family activities: <ul style="list-style-type: none"> ■ Single family detached dwelling. ■ Residential home, as defined under ORS 197.660. ■ Manufactured dwelling park, subject to SRC chapter 235.
	S	The following single family activities: <ul style="list-style-type: none"> ■ Manufactured home, subject to SRC 700.025. ■ Townhouse, subject to SRC 700.085. ■ Zero side yard dwelling, subject to SRC 700.095.
	N	All other Single Family.
Two family	P	The following two family activities: <ul style="list-style-type: none"> ■ Duplex, when located on a corner lot. ■ Duplex, when located on a lot whose side abuts property other than a street or alley in a Commercial (C) or Industrial (I) Zone, and the entire lot is located within 165 feet of the C or I zone.
	S	Two family shared dwelling, subject to SRC 700.090.
	N	All other two family.
<u>Three family</u>	<u>N</u>	
<u>Four family</u>	<u>N</u>	
Multiple family	N	
Group Living		
Room and board	N	
Residential care	C	Residential facility, as defined under ORS 197.660, when located on a lot with frontage on an arterial or collector street.
	N	All other residential care.
Nursing care	C	Nursing care, when located on a lot with frontage on an arterial or collector street.
	N	All other nursing care.
Lodging		
Short-term commercial lodging	C	Short-term rentals.
	N	All other short-term commercial lodging.

Long-term commercial lodging	N	
Nonprofit shelters	C	Nonprofit shelters serving 5 or fewer persons, when located on a lot with frontage on an arterial or collector street.
	P	Nonprofit shelters serving victims of domestic violence for 10 or fewer persons.
	N	All other nonprofit shelters.
Retail Sales and Service		
Eating and drinking establishments	N	
Retail sales	N	
Personal services	C	The following personal services activities: <ul style="list-style-type: none"> ■ Beauty salons. ■ Barber shops.
	N	All other personal services.
Postal services and retail financial services	N	
Business and Professional Services		
Office	N	
Audio/visual media production	N	
Laboratory research and testing	N	
Motor Vehicle, Trailer, and Manufactured Dwelling Sales and Services		
Motor vehicle and manufactured dwelling and trailer sales	N	
Motor vehicle services	N	
Commercial parking	N	Parking structures.
	S	All other commercial parking, subject to SRC 700.050.
Park-and-ride facilities	N	
Taxicabs and car services	N	

Heavy vehicle and trailer sales	N	
Heavy vehicle and trailer service and storage	N	
Recreation, Entertainment, and Cultural Services and Facilities		
Commercial entertainment—indoor	N	
Commercial entertainment—outdoor	S	Golf courses, subject to SRC 700.015.
	N	All other commercial entertainment—outdoor.
Major event entertainment	N	
Recreational and cultural community services	P	Libraries.
	S	Golf courses, subject to SRC 700.015.
	C	Community or neighborhood club buildings, including swimming pools and similar recreation facilities when operated by a nonprofit community club.
	N	All other recreation and cultural community services.
Parks and open space	N	Arboreta and botanical gardens.
	P	All other parks and open space.
Nonprofit membership assembly	C	
Religious assembly	S	Religious assembly, subject to SRC 700.055.
Health Services		
Medical centers/hospitals	N	
Outpatient medical services and laboratories	N	
Educational Services		
Day care	P	The following day care activities: <ul style="list-style-type: none"> ■ Child day care home. ■ Adult day care home.
	C	The following day care activities: <ul style="list-style-type: none"> ■ Child day care center. ■ Adult day care center.
	N	All other day care.
Basic education	S	Basic education, subject to SRC 700.010.

Post-secondary and adult education	N	
Civic Services		
Governmental services	N	
Social services	N	
Governmental maintenance services and construction	N	
Public Safety		
Emergency services	N	The following emergency services activities: <ul style="list-style-type: none"> ■ Ambulance stations. ■ Ambulance service facilities.
	P	All other emergency services.
Detention facilities	N	
Military installations	N	
Funeral and Related Services		
Cemeteries	N	
Funeral and cremation services	N	Crematories.
	C	All other funeral and cremation services.
Construction Contracting, Repair, Maintenance, and Industrial Services		
General repair services	N	
Building and grounds services and construction contracting	N	
Cleaning plants	N	
Industrial services	N	
Wholesale Sales, Storage, and Distribution		
General wholesaling	N	
Heavy wholesaling	N	
Warehousing and distribution	N	
Self-service storage	N	
Manufacturing		

General manufacturing	N	
Heavy manufacturing	N	
Printing	N	
Transportation Facilities		
Aviation facilities	N	
Passenger ground transportation facilities	P	Transit stop shelters.
	N	All other passenger ground transportation facilities.
Marine facilities	N	
Utilities		
Basic utilities	P	
Wireless communication facilities	Allowed	Wireless communication facilities are allowed, subject to SRC chapter 703.
Drinking water treatment facilities	C	
Power generation facilities	N	
Data center facilities	N	
Fuel dealers	N	
Waste-related facilities	N	
Mining and Natural Resource Extraction		
Petroleum and natural gas production	N	
Surface mining	N	
Farming, Forestry, and Animal Services		
Agriculture	N	Marijuana production.
	P	All other agriculture.
Forestry	P	
Agriculture and forestry services	N	
Keeping of livestock and other animals	N	
Animal services	C	Existing wildlife rehabilitation facility.
	N	All other animal services.

Other Uses		
Accessory short-term rentals	S	Accessory short-term rental, subject to SRC 700.006
Temporary uses	P	The following temporary uses: <ul style="list-style-type: none"> ■ Christmas tree sales, subject to SRC 701.015. ■ Residential sales/development office, subject to SRC 701.030. ■ Replacement single family dwelling, subject to SRC 701.025.
Home occupations	S	Home occupations, subject to SRC 700.020.
Guest houses and guest quarters	P	Guest houses and guest quarters are permitted as an accessory use to single family, provided such houses and quarters are dependent upon the main building for either kitchen or bathroom facilities, or both, and are used for temporary lodging and not as a place of residence.
Taking of boarders or leasing of rooms by resident family	P	Taking of boarders or leasing of rooms by a resident family is permitted as an accessory use to household living, provided the total number of boarders and roomers does not exceed 2 in any dwelling unit.
Storage of commercial vehicle as an accessory use to household living	P	Storage of a commercial vehicle as an accessory use to household living is permitted, provided no more than 1 commercial vehicle is stored per dwelling unit.
Historic resource adaptive reuse pursuant to SRC chapter 230	Allowed	Historic resource adaptive reuse pursuant to SRC chapter 230 is allowed, subject to SRC 230.085.
Accessory dwelling units	S	Accessory dwelling units, subject to SRC 700.007.

(b) Continued uses. Existing cottage housing within the RS zone constructed prior to May 15, 1979, but which would otherwise be made nonconforming by this chapter, is hereby deemed a continued use.

- (1) Building or structures housing a continued use may be structurally altered or enlarged, or rebuilt following damage or destruction, provided such alteration, enlargement, or rebuilding complies with the standards set forth in SRC 511.010(f).
- (2) Cease of occupancy of a building or structure for a continued use shall not preclude future use of the building or structure for that use; provided, however, conversion of the building or structure to another use shall thereafter prevent conversion back to that use.

Sec. 512.010. - Uses.

The permitted (P), special (S), conditional (C), and prohibited (N) uses in the RD zone are set forth in Table 512-1.

TABLE 512-1. USES

Use	Status	Limitations & Qualifications
Household Living		
Single family	P	The following single family activities: <ul style="list-style-type: none"> ■ Single family detached dwelling. ■ Residential home, as defined under ORS 197.660.
	S	The following single family activities: <ul style="list-style-type: none"> ■ Manufactured home, subject to SRC 700.025. ■ Townhouse, subject to SRC 700.085. ■ Zero side yard dwelling, subject to SRC 700.095.
	N	All other single family.
Two family	P	
<u>Three family</u>	<u>N</u>	
<u>Four family</u>	<u>N</u>	
Multiple family	N	
Group Living		
Room and board	N	
Residential care	S	Residential facility, as defined under ORS 197.660, subject to SRC 700.060.
	N	All other residential care.
Nursing care	S	Nursing care, subject to SRC 700.045.
Lodging		
Short-term commercial lodging	C	Short-term rentals.
	N	All other short-term commercial lodging.
Long-term commercial lodging	N	
Nonprofit shelters	C	Nonprofit shelters serving 5 or fewer persons.
	P	Nonprofit shelters serving victims of domestic violence for 10 or fewer persons.
	N	All other nonprofit shelters.
Retail Sales and Service		
Eating and drinking establishments	N	

Retail sales	N	
Personal services	N	
Postal services and retail financial services	N	
Business and Professional Services		
Office	N	
Audio/visual media production	N	
Laboratory research and testing	N	
Motor Vehicle, Trailer, and Manufactured Dwelling Sales and Services		
Motor vehicle and manufactured dwelling and trailer sales	N	
Motor vehicle services	N	
Commercial parking	N	
Park-and-ride facilities	N	
Taxicabs and car services	N	
Heavy vehicle and trailer sales	N	
Heavy vehicle and trailer service and storage	N	
Recreation, Entertainment, and Cultural Services and Facilities		
Commercial entertainment—indoor	C	Membership sports and recreation clubs.
	N	All other commercial entertainment—indoor.
Commercial Entertainment—outdoor	C	Membership sports and recreation clubs.
	N	All other commercial entertainment—outdoor.
Major event entertainment	N	
Recreational and cultural community services	P	Libraries.
	N	All other recreation and cultural community services.
Parks and open space	N	Arboreta and botanical gardens.
	P	All other parks and open space.

Nonprofit membership assembly	N	
Religious assembly	S	Religious assembly, subject to SRC 700.055.
Health Services		
Medical centers/hospitals	N	
Outpatient medical services and laboratories	N	
Educational Services		
Day care	P	Child day care home.
	C	Child day care center.
	N	All other day care.
Basic education	N	
Post-secondary and adult education	N	
Civic Services		
Governmental services	N	
Social services	N	
Governmental maintenance services and construction	N	
Public Safety		
Emergency services	N	The following emergency services activities: <ul style="list-style-type: none"> ■ Ambulance stations. ■ Ambulance service facilities.
	P	All other emergency services.
Detention facilities	N	
Military installations	N	
Funeral and Related Services		
Cemeteries	N	
Funeral and cremation services	N	
Construction Contracting, Repair, Maintenance, and Industrial Services		
General repair services	N	

Building and grounds services and construction contracting	N	
Cleaning plants	N	
Industrial services	N	
Wholesale Sales, Storage, and Distribution		
General wholesaling	N	
Heavy wholesaling	N	
Warehousing and distribution	N	
Self-service storage	N	
Manufacturing		
General manufacturing	N	
Heavy manufacturing	N	
Printing	N	
Transportation Facilities		
Aviation facilities	N	
Passenger ground Transportation facilities	P	Transit stop shelters.
	N	All other passenger ground transportation facilities.
Marine facilities	N	
Utilities		
Basic utilities	P	
Wireless communication facilities	Allowed	Wireless communication facilities are allowed, subject to SRC chapter 703.
Drinking water treatment facilities	C	
Power generation facilities	N	
Data center facilities	N	
Fuel dealers	N	
Waste-related facilities	N	
Mining and Natural Resource Extraction		

Petroleum and natural gas production	N	
Surface mining	N	
Farming, Forestry, and Animal Services		
Agriculture	N	Marijuana production.
	P	All other agriculture.
Forestry	P	
Agriculture and forestry services	N	
Keeping of livestock and other animals	N	
Animal services	N	
Other Uses		
Accessory short-term rentals	S	Accessory short-term rental, subject to SRC 700.006
Temporary uses	P	Christmas tree sales, subject to SRC 701.015.
Home occupations	S	Home occupations, subject to SRC 700.020.
Guest houses and guest quarters	P	Guest houses and guest quarters are permitted as an accessory use to single family, provided such houses and quarters are dependent upon the main building for either kitchen or bathroom facilities, or both, and are used for temporary lodging and not as a place of residence.
Taking of boarders or leasing of rooms by a resident family	P	Taking of boarders or leasing of rooms by a resident family is permitted as an accessory use to household living, provided the total number of boarders and roomers does not exceed 2 in any dwelling unit.
Storage of commercial vehicle as an accessory use to household living	P	Storage of a commercial vehicle as an accessory use to household living is permitted, provided no more than 1 commercial vehicle is stored per dwelling unit.
Historic Resource adaptive reuse pursuant to SRC chapter 230	Allowed	Historic resource adaptive reuse pursuant to SRC chapter 230 is allowed, subject to SRC 230.085.
Accessory dwelling units	S	Accessory dwelling units, subject to SRC 700.007.

Sec. 513.001. - Purpose.

The purpose of the Multiple Family Residential-I (RM-I) Zone is to implement the multiple family residential designation of the Salem Area Comprehensive Plan through the identification of allowed uses and the establishment of development standards. The RM-I zone generally allows multiple family, ~~and~~ two family, three family, and four family residential uses, along with a mix of other uses that are compatible with and/or provide services to the residential area.

Sec. 513.005. - Uses.

The permitted (P), special (S), conditional (C), and prohibited (N) uses in the RM-I zone are set forth in Table 513-1.

TABLE 513-1 USES		
Use	Status	Limitations & Qualifications
Household Living		
Single family	P	The following single family activities are permitted: <ul style="list-style-type: none"> ■ Single family detached dwelling. ■ Townhouse. ■ Residential home, as defined under ORS 197.660. ■ Manufactured dwelling park, subject to SRC chapter 235.
	S	The following single family activities: <ul style="list-style-type: none"> ■ Manufactured home, subject to SRC 700.025. ■ Zero side yard dwelling, subject to SRC 700.095.
	N	All other single family.
Two family	P	
<u>Three family</u>	<u>S</u>	<u>Subject to SRC 700.081.</u>
<u>Four family</u>	<u>S</u>	<u>Subject to SRC 700.081.</u>
Multiple family	P	
Group Living		
Room and board	P	Room and board serving 5 or fewer persons.
	C	Room and board serving 6 to 10 persons.
	N	All other room and board.
Residential care	P	
Nursing care	S	Nursing care, subject to SRC 700.045.
Lodging		
Short-term commercial lodging	P	Short-term rentals.
	N	All other short-term commercial lodging.

Long-term commercial lodging	N	
Nonprofit shelters	C	Nonprofit shelters serving up to 10 persons.
	P	Nonprofit shelters serving victims of domestic violence for 10 or fewer persons.
	N	All other nonprofit shelters.
Retail Sales and Service		
Eating and drinking establishments	N	
Retail sales	N	
Personal services	N	
Postal services and retail financial services	N	
Business and Professional Services		
Office	N	
Audio/visual media production	N	
Laboratory research and testing	N	
Motor Vehicle, Trailer, and Manufactured Dwelling Sales and Services		
Motor vehicle and manufactured dwelling and trailer sales	N	
Motor vehicle services	N	
Commercial parking	P	Commercial parking, when located on a lot whose side abuts property, other than a street or alley, within a commercial or industrial zone, and the lot is located entirely within 165 feet of the abutting commercial or industrial zone.
	N	All other commercial parking.
Park-and-ride facilities	P	Park-and ride facilities, when located on a lot whose side abuts property, other than a street or alley, within a commercial or industrial zone, and the lot is located entirely within 165 feet of the abutting commercial or industrial zone.

	N	All other park-and-ride facilities.
Taxicabs and car services	N	
Heavy vehicle and trailer sales	N	
Heavy vehicle and trailer service and storage	N	
Recreation, Entertainment, and Cultural Services and Facilities		
Commercial entertainment—indoor	C	Membership sports and recreation clubs.
	N	All other commercial entertainment—indoor.
Commercial entertainment—outdoor	C	Membership sports and recreation clubs.
	N	All other commercial entertainment—outdoor.
Major event entertainment	N	
Recreational and cultural community services	P	Libraries.
	C	All other recreation and cultural community services.
Parks and open space	C	Arboreta and botanical gardens.
	P	All other parks and open space.
Nonprofit membership assembly	N	
Religious assembly	S	Religious assembly, subject to SRC 700.055.
Health Services		
Medical centers/hospitals	N	
Outpatient medical services and laboratories	N	
Educational Services		
Day care	P	The following day care activities: <ul style="list-style-type: none"> ■ Child day care home. ■ Adult day care home.
	C	The following day care activities: <ul style="list-style-type: none"> ■ Child day care center. ■ Adult day care center.

	N	All other day care.
Basic education	S	Basic education, subject to SRC 700.010.
Post-secondary and adult education	N	
Civic Services		
Governmental services	N	
Social services	N	
Governmental maintenance services and construction	N	
Public Safety		
Emergency services	N	The following emergency services activities: <ul style="list-style-type: none"> ■ Ambulance stations. ■ Ambulance service facilities.
	P	All other emergency services.
Detention facilities	N	
Military installations	N	
Funeral and Related Services		
Cemeteries	N	
Funeral and cremation services	N	
Construction Contracting, Repair, Maintenance, and Industrial Services		
General repair services	N	
Building and grounds services and construction contracting	N	
Cleaning plants	N	
Industrial services	N	
Wholesale Sales, Storage, and Distribution		
General wholesaling	N	
Heavy wholesaling	N	
Warehousing and distribution	N	
Self-service storage	N	

Manufacturing		
General manufacturing	N	
Heavy manufacturing	N	
Printing	N	
Transportation Facilities		
Aviation facilities	N	
Passenger ground transportation facilities	P	Transit stop shelters.
	N	All other passenger ground transportation facilities.
Marine facilities	N	
Utilities		
Basic utilities	P	
Wireless communication facilities	Allowed	Wireless communication facilities are allowed, subject to SRC chapter 703.
Drinking water treatment facilities	C	
Power generation facilities	N	
Data center facilities	N	
Fuel dealers	N	
Waste-related facilities	N	
Mining and Natural Resource Extraction		
Petroleum and natural gas production	N	
Surface mining	N	
Farming, Forestry, and Animal Services		
Agriculture	N	
Forestry	N	
Agriculture and forestry services	N	
Keeping of livestock and other animals	N	

Animal services	N	
Other Uses		
Temporary uses	P	The following temporary uses: <ul style="list-style-type: none"> ■ Christmas tree sales, subject to SRC 701.015. ■ Residential sales/development office, subject to SRC 701.030.
Home occupations	S	Home occupations, subject to SRC 700.020.
Taking of boarders or leasing of rooms by a resident family	P	Taking of boarders or leasing of rooms by a resident family is permitted as an accessory use to household living, provided the total number of boarders and roomers does not exceed 2 in any dwelling unit.
Historic resource adaptive reuse pursuant to SRC chapter 230	Allowed	Historic resource adaptive reuse pursuant to SRC chapter 230 is allowed, subject to SRC 230.085.
Accessory dwelling units	S	Accessory dwelling units, subject to SRC 700.007.

Sec. 513.010. - Development standards.

Development within the RM-I zone must comply with the development standards set forth in this section.

- (a) *Land division in the RM-I zone.* Lots subdivided or partitioned in the RM-I zone shall be a minimum of 20,000 square feet in size, unless the lots are restricted to contain two or more attached dwelling units per lot, are used for townhouse development, or are used for allowed uses other than household living.
- (b) *Lot standards.* Lots within the RM-I zone shall conform to the standards set forth in Table 513-2.

TABLE 513-2. LOT STANDARDS		
Requirement	Standard	Limitations & Qualifications
Lot Area		
Single family	Min. 1,500 sq. ft.	Applicable to townhouses.
	Min. 4,000 sq. ft.	Applicable to all other single family.
All other uses	Min. 4,000 sq. ft.	
Lot Width		

Single family	Min. 20 ft.	Applicable to townhouses.
	Min. 40 ft.	Applicable to all other single family.
All other uses	Min. 40 ft.	
Lot Depth		
All uses	Min. 70 ft.	
	Min. 120 ft.	Applicable to double frontage lots.
	Max. 300% of average lot width	
Street Frontage		
Single family	Min. 20 ft.	Applicable to townhouses.
	Min. 40 ft.	Applicable to all other single family.
	Min. 30 ft.	Applicable to all other single family, when located on a lot fronting on the turnaround of a cul-de-sac street or the outside curve of a curved street having a radius of 200 feet or less and a direction change of 60 degrees or more. In no case shall the lot width be less than 40 ft. at the front building setback line.
All other uses	Min. 40 ft.	

(c) *Dwelling unit density.* Dwelling unit density within the RM-I zone shall conform to the standards set forth in Table 513-3. Maximum dwelling unit density cannot be varied or adjusted.

TABLE 513-3. DWELLING UNIT DENSITY			
Use	Standard		Limitations & Qualifications
	Minimum	Maximum	
Single family, two family, <u>three family</u> , <u>four family</u> , and multiple family	8 dwelling units per acre	14 dwelling units per acre	Applicable to manufactured >dwelling parks developed pursuant to SRC chapter 235.
	6 dwelling unit per acre	14 dwelling units per acre	

(d) *Setbacks.* Setbacks within the RM-I zone shall be provided as set forth in Tables 513-4 and 513-5.

TABLE 513-4. SETBACKS

Requirement	Standard	Limitations & Qualifications
Abutting Street		
Buildings		
Single family, and two family, <u>three family, and four family</u>	Min. 12 ft.	
	Min. 20 ft.	Applicable along collector or arterial streets.
All other uses	Min. 12 ft., plus 1 ft. for each 1 ft. of height over 12 ft., but need not exceed 20 ft. in depth.	
Accessory Structures		
Accessory to single family, and two family, <u>three family, and four family</u>	None	Applicable to accessory structures not more than 4 ft. in height.
	Min. 12 ft.	Applicable to accessory structures greater than 4 ft. in height.
	Min. 20 ft.	Applicable to accessory structures greater than 4 ft. in height, when located in a yard adjacent to a collector or arterial street.
Accessory to all other uses	None	Applicable to accessory structures not more than 4 ft. in height.
	Min. 12 ft., plus 1 ft. for each 1 ft. of height over 12 ft.	Applicable to accessory structures greater than 4 ft. in height.
Vehicle Use Areas		
All uses, other than single family, and two family, <u>three family, and four family</u>	Min. 12 ft.	
Interior Front		
Buildings		
Single family, and two family, <u>three family, and four family</u>	Min. 12 ft.	
All other uses	Zone-to-zone setback (Table 513-5)	

Accessory structures		
Accessory to single family, and two family, <u>three family, and four family</u>	Min. 5 ft.	
Accessory to all other uses	Zone-to-zone setback (Table 513-5)	
Vehicle use areas		
All uses, other than single family, and two family, <u>three family, and four family</u>	Zone-to-zone setback (Table 513-5)	
Interior Side		
Buildings		
Single family	Min. 5 ft.	Applicable to new buildings, other than townhouses and zero side yard dwellings.
	Min. 3 ft.	Applicable to existing buildings, other than townhouses and zero side yard dwellings.
	None	Applicable to townhouses.
	Per SRC 700.095	Applicable to zero side yard dwellings.
Two family, three family, <u>and four family</u>	Min. 5 ft.	
All other uses	Zone-to-zone setback (Table 513-5)	
Accessory Structures		
Accessory to single family, and two family, <u>three family, and four family</u>	None	Applicable to accessory structures having at least 1 wall which is an integral part of a fence.
	Min. 5 ft.	Applicable to all other accessory structures.
Accessory to all other uses	Zone-to-zone setback (Table 513-5)	
Vehicle Use Areas		
All uses, other than single family, and two family,	Zone-to-zone setback (Table 513-5)	

<u>three family, and four family</u>		
Interior Rear		
Buildings		
Single family, and two family, <u>three family, and four family</u>	Min. 14 ft.	Applicable to any portion of a building not more than 1 story in height.
	Min. 20 ft.	Applicable to any portion of a building greater than 1 story in height.
All other uses	Zone-to-zone setback (Table 513-5)	
Accessory Structures		
Accessory to single family, and two family, <u>three family, and four family</u>	None	Applicable to accessory structures not more than 9 ft. in height.
	Min. 1 ft. for each 1 ft. of height over 9 ft.	Applicable to accessory structures greater than 9 ft. in height.
	Min. 1 ft.	Applicable to accessory structures adjacent to an alley, unless a greater setback is required based on the height of the accessory structure.
Accessory to all other uses	Zone-to-zone setback (Table 513-5)	
Vehicle Use Areas		
All uses, other than single family, and two family, <u>three family, and four family</u>	Zone-to-zone setback (Table 513-5)	

TABLE 513-5. ZONE-TO-ZONE SETBACKS

Abutting Zone	Type of Improvement	Setback (1)	Landscaping & Screening
EFU	Buildings and accessory structures	Min. 10 ft.	Type C
	Vehicle use areas		
Residential Zone	Buildings and accessory structures	Min. 10 ft.	Type C

	Vehicle use areas		
Mixed-Use Zone	Buildings and accessory structures	Min. 10 ft.	Type C
	Vehicle use areas		
Commercial Zone	Buildings and accessory structures	Min. 10 ft.	Type C
	Vehicle use areas		
Public Zone	Buildings and accessory structures	Min. 10 ft.	Type C
	Vehicle use areas		
Industrial and Employment Zone	Buildings and accessory structures	Min. 15 ft.	Type C
	Vehicle use areas		
Limitations and Qualifications			
(1) Zone-to-Zone setbacks are not required abutting an alley.			

(e) *Lot coverage; height.* Buildings and accessory structures within the RM-I zone shall conform to the lot coverage and height standards set forth in Table 513-6.

TABLE 513-6. LOT COVERAGE; HEIGHT		
Requirement	Standard	Limitations & Qualifications
Lot Coverage		
Buildings and Accessory Structures		
All uses	Max. <u>560%</u>	
Rear Yard Coverage		
Buildings		
All uses	N/A	
Accessory Structures		
Accessory to single family, and two family, <u>three family,</u> <u>and four family</u>	Max. 25%	
Accessory to all other uses	No Max.	
Height		

Buildings		
Single family, two family, <u>three family, four family, multiple family</u> , residential care, nursing care, and short-term commercial lodging	Max. 35 ft.	
All other uses	Max. 70 ft.	
Accessory Structures		
Accessory to all uses	Max 15 ft.	

- (f) *Maximum square footage for all accessory structures.* In addition to the maximum coverage requirements established in Table 513-6, accessory structures to single family and two family uses shall be limited to the maximum aggregate total square footage set forth in Table 513-7.

TABLE 513-7. MAXIMUM SQUARE FOOTAGE FOR ALL ACCESSORY STRUCTURES	
Main Building Gross Area	Maximum Aggregate Total Square Footage for All Accessory Structures
1,200 square feet or less	600 sq. ft.
Greater than 1,200 square feet	1,000 sq. ft. or 50% of main building gross area, whichever is less

- (g) *Landscaping.* Landscaping within the RM-I zone shall be provided as set forth in this subsection.
- (1) *Setbacks.* Required setbacks shall be landscaped. Landscaping shall conform to the standards set forth in SRC chapter 807.
 - (2) *Vehicle use areas.* Vehicle use areas shall be landscaped as provided under SRC chapters 806 and 807.
- (h) *Outdoor storage.* Within the RM-I zone, outdoor storage shall be screened from streets and adjacent properties by a minimum six-foot-high sight-obscuring fence, wall, or hedge.

Sec. 513.015. - Design review.

Design review under SRC chapter 225 is required for development within the RM-I as follows:

- (a) Multiple family development shall be subject to design review according to the ~~multiple family design review guidelines~~ or the multiple family design review standards set forth in SRC chapter 702.
- (b) Residential care with ~~three~~five or more self-contained dwelling units shall be subject to design review according to the ~~multiple family design review guidelines~~ or the multiple family design review standards set forth in SRC chapter 702.

Sec. 514.005. - Uses.

The permitted (P), special (S), conditional (C), and prohibited (N) uses in the RM-II zone are set forth in Table 514-1.

TABLE 514-1. USES		
Use	Status	Limitations & Qualifications
Household Living		
Single family	P	The following single family activities: <ul style="list-style-type: none"> ■ Replacement of existing single family detached dwelling. ■ New single family detached dwelling on a nonconforming lot of record less than 6,000 square feet in area. ■ Townhouse. ■ Residential home, as defined under ORS 197.660. ■ Manufactured dwelling park, subject to SRC chapter 235.
	S	The following single family activities: <ul style="list-style-type: none"> ■ Replacement of existing manufactured home, subject to SRC 700.025. ■ Zero side yard dwelling, subject to SRC 700.095.
	N	All other single family.
Two family	P	
<u>Three family</u>	<u>S</u>	<u>Subject to SRC 700.081.</u>
<u>Four family</u>	<u>S</u>	<u>Subject to SRC 700.081.</u>
Multiple family	P	
Group Living		
Room and board	P	Room and board serving 5 or fewer persons.
	C	Room and board serving 6 to 10 persons.
	N	All other room and board.
Residential care	P	
Nursing care	S	Nursing care, subject to SRC 700.040.
Lodging		
Short-term commercial lodging	P	Short-term rentals.
	N	All other short-term commercial lodging.
Long-term commercial lodging	N	
Nonprofit shelters	P	Nonprofit shelters serving 5 or fewer persons.
	C	Nonprofit shelters serving 6 to 10 persons.

	P	Nonprofit shelters serving victims of domestic violence for 10 or fewer persons.
	N	All other nonprofit shelters.
Retail Sales and Service		
Eating and drinking establishments	N	
Retail sales	N	
Personal services	C	The following personal services activities: <ul style="list-style-type: none"> ■ Beauty salons. ■ Barber shops.
	N	All other personal services.
Postal services and retail financial services	N	
Business and Professional Services		
Office	N	
Audio/visual media production	N	
Laboratory research and testing	N	
Motor Vehicle, Trailer, and Manufactured Dwelling Sales and Services		
Motor vehicle and manufactured dwelling and trailer sales	N	
Motor vehicle services	N	
Commercial parking	P	Commercial parking, when located on a lot whose side abuts property, other than a street or alley, within a commercial or industrial zone, and the lot is located entirely within 165 feet of the abutting commercial or industrial zone.
	N	All other commercial parking.
Park-and-ride facilities	P	Park-and-ride facilities, when located on a lot whose side abuts property, other than a street or alley, within a commercial or industrial zone, and the lot is located entirely within 165 feet of the abutting commercial or industrial zone.
	N	All other park-and-ride facilities.

Taxicabs and car services	N	
Heavy vehicle and trailer sales	N	
Heavy vehicle and trailer service and storage	N	
Recreation, Entertainment, and Cultural Services and Facilities		
Commercial entertainment—indoor	C	Membership sports and recreation clubs.
	N	All other commercial entertainment—indoor.
Commercial entertainment—outdoor	S	Golf courses, subject to SRC 700.015.
	C	Membership sports and recreation clubs.
	N	All other commercial entertainment—outdoor.
Major event entertainment	N	
Recreational and cultural community services	P	Libraries.
	C	All other recreation and cultural community services.
Parks and open space	C	Arboreta and botanical gardens.
	P	All other parks and open space.
Nonprofit membership assembly	C	
Religious assembly	S	Religious assembly, subject to SRC 700.055.
Health Services		
Medical centers/hospitals	N	
Outpatient medical services and laboratories	N	
Educational Services		
Day care	P	The following day care activities: <ul style="list-style-type: none"> ■ Child day care home. ■ Adult day care home.

	C	The following day care activities: ■ Child day care center. ■ Adult day care center.
	N	All other day care.
Basic education	S	Basic education, subject to SRC 700.010.
Post-secondary and adult education	N	
Civic Services		
Governmental services	N	
Social services	N	
Governmental maintenance services and construction	N	
Public Safety		
Emergency services	N	Ambulance service facilities.
	P	All other emergency services.
Detention facilities	N	
Military installations	N	
Funeral and Related Services		
Cemeteries	N	
Funeral and cremation services	N	Crematories.
	C	All other funeral and cremation services.
Construction Contracting, Repair, Maintenance, and Industrial Services		
General repair services	N	
Building and grounds services and construction contracting	N	
Cleaning plants	N	
Industrial services	N	
Wholesale Sales, Storage, and Distribution		
General wholesaling	N	
Heavy wholesaling	N	
Warehousing and distribution	N	

Self-service storage	N	
Manufacturing		
General manufacturing	N	
Heavy manufacturing	N	
Printing	N	
Transportation Facilities		
Aviation facilities	N	
Passenger ground transportation facilities	P	Transit stop shelters.
	N	All other passenger ground transportation facilities.
Marine facilities	N	
Utilities		
Basic utilities	P	
Wireless communication facilities	Allowed	Wireless communication facilities are allowed, subject to SRC chapter 703.
Drinking water treatment facilities	C	
Power generation facilities	N	
Data center facilities	N	
Fuel dealers	N	
Waste-related facilities	N	
Mining and Natural Resource Extraction		
Petroleum and natural gas production	N	
Surface mining	N	
Farming, Forestry, and Animal Services		
Agriculture	N	Marijuana production.
	P	All other agriculture.
Forestry	P	
Agriculture and forestry services	N	
Keeping of livestock and other animals	N	

Animal services	N	
Other Uses		
Temporary uses	P	Christmas tree sales, subject to SRC 701.015.
Home occupations	S	Home occupations are allowed subject to SRC 700.020.
Guest houses and guest quarters	P	Guest houses and guest quarters are permitted as an accessory use to single family, provided such houses and quarters are dependent upon the main building for either kitchen or bathroom facilities, or both, and are used for temporary lodging and not as a place of residence.
Taking of boarders or leasing of rooms by resident family	P	The taking of boarders or leasing of rooms by a resident family is permitted as an accessory use to household living, provided the total number of boarders and roomers does not exceed 2 in any dwelling unit.
Storage of commercial vehicle as an accessory use to household living	P	Storage of a commercial vehicle as an accessory use to household living is permitted, provided no more than 1 commercial vehicle is stored per dwelling unit.
Historic resource adaptive reuse pursuant to SRC chapter 230	Allowed	Historic resource adaptive reuse pursuant to SRC chapter 230 is allowed, subject to SRC 230.085.
Accessory dwelling units	S	Accessory dwelling units, subject to SRC 700.007.

Sec. 514.010. - Development standards.

Development within the RM-II zone must comply with the development standards set forth in this section.

- (a) *Land division in the RM-II zone.* Lots subdivided or partitioned in the RM-II zone shall be a minimum of 20,000 square feet in size, unless the lots are restricted to contain three or more attached dwelling units per lot, are used for townhouse development, or are used for allowed uses other than household living.
- (b) *Lot standards.* Lots within the RM-II zone shall conform to the standards set forth in Table 514-2.

TABLE 514-2. LOT STANDARDS		
Requirement	Standard	Limitations & Qualifications
Lot Area		
Single family	Min. 1,500 sq. ft.	Applicable to townhouses.

	Min. 6,000 sq. ft.	Applicable to all other single family, except new single family detached dwellings on nonconforming lots of record less than 6,000 square feet in area.
All other uses	Min. 6,000 sq. ft.	
Lot Width		
Single family	Min. 20 ft.	Applicable to townhouses.
	Min. 40 ft.	Applicable to all other single family.
All Other Uses	Min. 40 ft.	
Lot Depth		
Single family	Min. 70 ft.	
	Min. 120 ft.	Applicable to double frontage lots.
	Max. 300% of average lot width	
All other uses	Min. 80 ft.	
	Min. 120 ft.	Applicable to double frontage lots.
	Max. 300% of average lot width	
Street Frontage		
Single family	Min. 20 ft.	Applicable to townhouses.
	Min. 40 ft.	Applicable to all other single family.
	Min. 30 ft.	Applicable to all other single family, when located on a lot fronting on the turnaround of a cul-de-sac street or the outside curve of a curved street having a radius of 200 feet or less and a direction change of 60 degrees or more. In no case shall the lot width be less than 40 ft. at the front building setback line.
All other uses	Min. 40 ft.	

- (c) *Dwelling unit density.* Dwelling unit density within the RM-II zone shall conform to the standards set forth in Table 514-3. Maximum dwelling unit density cannot be varied or adjusted.

TABLE 514-3. DWELLING UNIT DENSITY

Use	Standard		Limitations & Qualifications
	Minimum	Maximum	
Single family, two family, <u>three family</u> , <u>four family</u> , and multiple family	12 dwelling units per acre	28 dwelling units per acre	
	N/A	N/A	Applicable to new single family detached dwelling on nonconforming lot of record less than 6,000 square feet in area.
	6 dwelling units per acre	28 dwelling units per acre	Applicable to manufactured dwelling parks developed pursuant to SRC chapter 235.

- (d) *Setbacks.* Setbacks within the RM-II zone shall be provided as set forth in Tables 514-4 and 514-5.

TABLE 514-4. SETBACKS

Requirement	Standard	Limitations & Qualifications
Abutting Street		
Buildings		
Single family, and two family , <u>three family</u> , and <u>four family</u>	Min. 12 ft.	
	Min. 20 ft.	Applicable along collector or arterial streets.
All other uses	Min. 12 ft., plus 1 ft. for each 1 ft. of height over 12 ft., but need not exceed 20 ft. in depth.	
Accessory Structures		
Accessory to single family, and two family , <u>three family</u> , and <u>four family</u>	None	Applicable to accessory structures not more than 4 ft. in height.
	Min. 12 ft.	Applicable to accessory structures greater than 4 ft. in height.
	Min. 20 ft.	Applicable to accessory structures greater than 4 ft. in height, when located in a yard adjacent to a collector or arterial street.

Accessory to all other uses	None	Applicable to accessory structures not more than 4 ft. in height.
	Min. 12 ft., plus 1 ft. for each 1 ft. of height over 12 ft.	Applicable to accessory structures greater than 4 ft. in height.
Vehicle Use Areas		
All uses, other than single family, and two family, <u>three family, and four family</u>	Min. 12 ft.	
Interior Front		
Buildings		
Single family, and two family, <u>three family, and four family</u>	Min. 12 ft.	
All other uses	Zone-to-zone setback (Table 514-5)	
Accessory Structures		
Accessory to single family, and two family, <u>three family, and four family</u>	Min. 5 ft.	
Accessory to all other uses	Zone-to-zone setback (Table 514-5)	
Vehicle Use Areas		
All uses, other than single family, and two family, <u>three family, and four family</u>	Zone-to-zone setback (Table 514-5)	
Interior Side		
Buildings		
Single family	Min. 5 ft.	Applicable to new buildings, other than townhouses and zero side yard dwellings.
	Min. 3 ft.	Applicable to existing buildings, other than townhouses and zero side yard dwellings.
	None	Applicable to townhouses.

	Per SRC 700.095	Applicable to zero side yard dwellings.
Two family, three family, <u>and four family</u>	Min. 5 ft.	
All other uses	Zone-to-zone setback (Table 514-5)	
Accessory Structures		
Accessory to single family, and two family, <u>three family, and four family</u>	None	Applicable to accessory structures having at least 1 wall which is an integral part of a fence.
	Min. 5 ft.	Applicable to all other accessory structures.
Accessory to all other uses	Zone-to-zone setback (Table 514-5)	
Vehicle Use Areas		
All uses, other than single family, and two family, <u>three family, and four family</u>	Zone-to-zone setback (Table 514-5)	
Interior Rear		
Buildings		
Single family, and two family, <u>three family, and four family</u>	Min. 14 ft.	Applicable to any portion of a building not more than 1 story in height.
	Min. 20 ft.	Applicable to any portion of a building greater than 1 story in height.
All other uses	Zone-to-zone setback (Table 514-5)	
Accessory Structures		
Accessory to single family, and two family, <u>three family, and four family</u>	None	Applicable to accessory structures not more than 9 ft. in height.
	Min. 1 ft. for each 1 ft. of height over 9 ft.	Applicable to accessory structures greater than 9 ft. in height.
	Min. 1 ft.	Applicable to accessory structures adjacent to an alley, unless a greater setback is required based on the height of the accessory structure.
Accessory to all other uses	Zone-to-zone setback (Table 514-5)	

Vehicle Use Areas		
All uses, other than single family, and two family, <u>three family, and four family</u>	Zone-to-zone setback (Table 514-5)	

TABLE 514-5. ZONE-TO-ZONE SETBACKS

Abutting Zone	Type of Improvement	Setback ⁽¹⁾	Landscaping & Screening
EFU	Buildings and accessory structures	Min. 10 ft.	Type C
	Vehicle use areas		
Residential Zone	Buildings and accessory structures	Min. 10 ft.	Type C
	Vehicle use areas		
Mixed-Use Zone	Buildings and accessory structures	Min. 10 ft.	Type C
	Vehicle use areas		
Commercial Zone	Buildings and accessory structures	Min. 10 ft.	Type C
	Vehicle use areas		
Public Zone	Buildings and accessory structures	Min. 10 ft.	Type C
	Vehicle use areas		
Industrial and Employment Zone:	Buildings and accessory structures	Min. 15 ft.	Type C
	Vehicle use areas		

Limitations and Qualifications

⁽¹⁾ Zone-to-Zone setbacks are not required abutting an alley.

(e) *Lot coverage; height.* Buildings and accessory structures within the RM-II zone shall conform to the lot coverage and height standards set forth in Table 514-6.

TABLE 514-6. LOT COVERAGE; HEIGHT

Requirement	Standard	Limitations & Qualifications
Lot Coverage		
Buildings and Accessory Structures		
All uses	Max. <u>560%</u>	
Rear Yard Coverage		
Buildings		
All uses	N/A	
Accessory Structures		
Accessory to single family, and two family, three family, and four family	Max. 25%	
Accessory to all other uses	No Max.	
Height		
Buildings		
Single family, and two family, three family, and four family	Max. 35 ft.	
Multiple family, residential care, nursing care, and short-term commercial lodging	Max. 50 ft.	
All other uses	Max. 70 ft.	
Accessory Structures		
Accessory to all uses	Max 15 ft.	

(f) *Maximum square footage for all accessory structures.* In addition to the maximum coverage requirements established in Table 514-6, accessory structures to single family and two family uses shall be limited to the maximum aggregate total square footage set forth in Table 514-7.

TABLE 514-7. MAXIMUM SQUARE FOOTAGE FOR ALL ACCESSORY STRUCTURES	
Main Building Gross Area	Maximum Total Square Footage for All Accessory Structures
1,200 square feet or less.	600 sq. ft.
Greater than 1,200 square feet.	1,000 sq. ft. or 50% of main building gross area, whichever is less.

(g) *Landscaping.* Landscaping within the RM-II zone shall be provided as set forth in this subsection.

- (1) *Setbacks.* Required setbacks shall be landscaped. Landscaping shall conform to the standards set forth in SRC chapter 807.
- (2) *Vehicle use areas.* Vehicle use areas shall be landscaped as provided under SRC chapters 806 and 807.
- (h) *Outdoor storage.* Within the RM-II zone, outdoor storage shall be screened from streets and adjacent properties by a minimum six-foot-high sight-obscuring fence, wall, or hedge.

Sec. 514.015. - Design review.

Design review under SRC chapter 225 is required for development within the RM-II as follows:

- (a) Multiple family development shall be subject to design review according to ~~the multiple family design review guidelines or the multiple family design review standards set forth in SRC chapter 702.~~
- (b) Residential care with ~~five~~three or more self-contained dwelling units shall be subject to design review according to ~~the multiple family design review guidelines or the multiple family design review standards set forth in SRC chapter 702.~~

Sec. 515.005. - Uses.

The permitted (P), special (S), conditional (C), and prohibited (N) uses in the RH zone are set forth in Table 515-1.

TABLE 515-1. USES		
Use	Status	Limitations & Qualifications
Household Living		
Single family	P	The following single family activities: <ul style="list-style-type: none"> ■ Replacement of single family detached dwelling existing on October 23, 2013. ■ Residential home, as defined under ORS 197.660. q >
	C	New single family detached dwelling, other than the replacement of a single family detached dwelling existing on October 23, 2013.
	N	All other single family.
Two family	P	
<u>Three family</u>	<u>S</u>	<u>Subject to SRC 700.081.</u>
<u>Four family</u>	<u>S</u>	<u>Subject to SRC 700.081.</u>
Multiple family	P	
Group Living		
Room and board	P	Room and board serving 5 or fewer persons.

	C	Room and board serving 6 to 10 persons.
	N	All other room and board.
Residential care	P	
Nursing care	S	Nursing care, subject to SRC 700.045.
Lodging		
Short-term commercial lodging	P	Short-term rentals.
	N	All other short-term commercial lodging.
Long-term commercial lodging	P	
Nonprofit shelters	P	Nonprofit shelters serving 5 or fewer persons.
	C	Nonprofit shelters serving 6 to 10 persons.
	P	Nonprofit shelters serving victims of domestic violence for 10 or fewer persons.
	N	All other nonprofit shelters.
Retail Sales and Service		
Eating and drinking establishments	N	
Retail sales	N	
Personal services	C	The following personal services activities: <ul style="list-style-type: none"> ■ Beauty salons. ■ Barber shops.
	N	All other personal services.
Postal services and retail financial services	N	
Business and Professional Services		
Office	N	
Audio/visual media production	N	
Laboratory research and testing	N	
Motor Vehicle, Trailer, and Manufactured Dwelling Sales and Services		
Motor vehicle and manufactured dwelling and trailer sales	N	

Motor vehicle services	N	
Commercial parking	P	Commercial parking, when located on a lot whose side abuts property, other than a street or alley, within a commercial or industrial zone, and the lot is located entirely within 165 feet of the abutting commercial or industrial zone.
	N	All other commercial parking.
Park-and-ride facilities	P	Park-and-ride facilities, when located on a lot whose side abuts property, other than a street or alley, within a commercial or industrial zone, and the lot is located entirely within 165 feet of the abutting commercial or industrial zone.
	N	All other park-and-ride facilities.
Taxicabs and car services	N	
Heavy vehicle and trailer sales	N	
Heavy vehicle and trailer service and storage	N	
Recreation, Entertainment, and Cultural Services and Facilities		
Commercial entertainment—indoor	C	Membership sports and recreation clubs.
	N	All other commercial entertainment—indoor.
Commercial entertainment—outdoor	C	Membership sports and recreation clubs.
	N	All other commercial entertainment—outdoor.
Major event entertainment	N	
Recreational and cultural community services	P	Libraries.
	C	All other recreation and cultural community services.
Parks and open space	C	Arboreta and botanical gardens.
	P	All other parks and open space.
Nonprofit membership assembly	C	
Religious assembly	S	Religious Assembly is allowed, subject to SRC 700.055.
Health Services		

Medical centers/hospitals	N	
Outpatient medical services and laboratories	N	
Educational Services		
Day care	P	The following day care activities: <ul style="list-style-type: none"> ■ Child day care home. ■ Adult day care home.
	C	The following day care activities: <ul style="list-style-type: none"> ■ Child day care center. ■ Adult day care center.
	N	All other day care.
Basic education	S	Basic education, subject to SRC 700.010.
Post-secondary and adult education	N	
Civic Services		
Governmental services	N	
Social services	N	
Governmental maintenance services and construction	N	
Public Safety		
Emergency services	N	Ambulance service facilities.
	P	All other emergency services.
Detention facilities	N	
Military installations	N	
Funeral and Related Services		
Cemeteries	N	
Funeral and cremation services	N	
Construction Contracting, Repair, Maintenance, and Industrial Services		
General repair services	N	
Building and grounds services and construction contracting	N	

Cleaning plants	N	
Industrial services	N	
Wholesale Sales, Storage, and Distribution		
General wholesaling	N	
Heavy wholesaling	N	
Warehousing and distribution	N	
Self-service storage	N	
Manufacturing		
General manufacturing	N	
Heavy manufacturing	N	
Printing	N	
Transportation Facilities		
Aviation facilities	N	
Passenger ground transportation facilities	P	Transit stop shelters.
	N	All other passenger ground transportation facilities.
Marine facilities	N	
Utilities		
Basic utilities	P	
Wireless communication facilities	Allowed	Wireless communication facilities are allowed, subject to SRC chapter 703.
Drinking water treatment facilities	C	
Power generation facilities	N	
Data center facilities	N	
Fuel dealers	N	
Waste-related facilities	N	
Mining and Natural Resource Extraction		
Petroleum and natural gas production	N	
Surface mining	N	

Farming, Forestry, and Animal Services		
Agriculture	N	Marijuana production.
	P	All other agriculture.
Forestry	P	
Agriculture and forestry services	N	
Keeping of livestock and other animals	N	
Animal services	N	
Other Uses		
Temporary uses	P	The following temporary uses: <ul style="list-style-type: none"> ■ Christmas tree sales, subject to SRC 701.015. ■ Residential sales/development office, subject to SRC 701.030.
Home occupations	S	Home occupations, subject to SRC 700.020.
Guest houses and guest quarters	P	Guest houses and guest quarters are permitted as an accessory use to single family, provided such houses and quarters are dependent upon the main building for either kitchen or bathroom facilities, or both, and are used for temporary lodging and not as a place of residence.
Taking of boarders or leasing of rooms by a resident family	P	The taking of boarders or leasing of rooms by a resident family is permitted as an accessory use to household living, provided the total number of boarders and roomers does not exceed 2 in any dwelling unit.
Storage of commercial vehicle as an accessory use to household living	P	Storage of a commercial vehicle as an accessory use to household living is permitted, provided no more than 1 commercial vehicle is stored per dwelling unit.
Nonresidential uses in a mixed-use project	S	Nonresidential uses in a mixed-use project, subject to SRC 700.040.
Historic resource adaptive reuse pursuant to SRC chapter 230	Allowed	Historic resource adaptive reuse pursuant to SRC chapter 230 is allowed, subject to SRC 230.085.
Accessory dwelling units	S	Accessory dwelling units, subject to SRC 700.007.

Sec. 515.010. - Development standards.

Development within the RH zone must comply with the development standards set forth in this section.

- (a) *Lot standards.* Lots within the RH zone shall conform to the standards set forth in Table 515-2.

TABLE 515-2. LOT STANDARDS		
Requirement	Standard	Limitations & Qualifications
Lot Area		
All uses	None	
Lot Width		
All uses	None	
Lot Depth		
All uses	None	
Street Frontage		
Single family	Min. 40 ft.	
All other uses	Min. 16 ft.	

- (b) *Setbacks.* Setbacks within the RH zone shall be provided as set forth in Table 515-3.

TABLE 515-3. SETBACKS		
Requirement	Standard	Limitations & Qualifications
Abutting Street		
Buildings		
All uses	None	Applicable to buildings on lots located within the CSDP area.
	Min. 12 ft.	Applicable to buildings on lots located outside the CSDP area.
Accessory Structures		
Accessory to all uses	None	Applicable to accessory structures not more than 4 ft. in height.
	None	Applicable to accessory structures greater than 4 ft. in height on lots located within the CSDP area.
	Min. 12 ft.	Applicable to accessory structures greater than 4 ft. in height on lots located outside the CSDP area.

Vehicle Use Areas		
All uses	Per SRC chapter 806	
Interior Front		
Buildings		
All uses	None	Applicable to buildings on lots located within the CSDP area.
	Min. 12 ft.	Applicable to buildings on lots located outside the CSDP area.
Accessory Structures		
Accessory to all uses	None	Applicable to accessory structures not more than 4 ft. in height.
	None	Applicable to accessory structures greater than 4 ft. in height on lots located within the CSDP area.
	Min. 12 ft.	Applicable to accessory structures greater than 4 ft. in height on lots located outside the CSDP area.
Vehicle Use Areas		
All uses	Per SRC chapter 806	
Interior Side		
Buildings		
All uses	Min. 5 ft.	Applicable to buildings not more than 35 ft. in height.
	Min. 5 ft., plus 1 ft. for each 1 ft. of height over 35 ft., but need not exceed 20 ft. in depth.	Applicable to buildings greater than 35 ft. in height.
Accessory Structures		
Accessory to all uses	None	Applicable to accessory structures having at least 1 wall which is an integral part of a fence.
	Min. 5 ft.	Applicable to all other accessory structures.
Vehicle Use Areas		
All uses	Per SRC chapter 806	
Interior Rear		

Buildings		
All uses	Min. 5 ft.	Applicable to buildings not more than 35 ft. in height.
	Min. 5 ft., plus 1 ft. for each 1 ft. of height over 35 ft., but need not exceed 20 ft. in depth.	Applicable to buildings greater than 35 ft. in height.
Accessory Structures		
Accessory to all uses	None	Applicable to accessory structures not more than 9 ft. in height.
	Min. 1 ft. for each 1 ft. of height over 9 ft.	Applicable to accessory structures greater than 9 ft. in height.
	Min. 1 ft.	Applicable to accessory structures adjacent to an alley, unless a greater setback is required based on the height of the accessory structure.
Vehicle Use Areas		
All uses	Per SRC chapter 806	

(c) *Lot coverage; height.* Buildings and accessory structures within the RH zone shall conform to the lot coverage and height standards set forth in Table 515-4.

TABLE 515-4. LOT COVERAGE; HEIGHT		
Requirement	Standard	Limitations & Qualifications
Lot Coverage		
Buildings and Accessory Structures		
All uses	No Max.	
Rear Yard Coverage		
Buildings		
All uses	N/A	
Accessory Structures		
Accessory to single family, and two family, three family, and four family	Max. 25%	
Accessory to all other uses	No Max.	
Height		

Buildings		
All uses	No Max.	
Accessory Structures		
Accessory to single family, two family, <u>three family, four family,</u> and multiple family	Max. 15 ft.	
Accessory to all other uses	No Max.	

- (d) *Maximum square footage for all accessory structures.* In addition to the maximum coverage requirements established in Table 515-4, accessory structures to single family and two family uses shall be limited to the maximum aggregate total square footage set forth in Table 515-5.

TABLE 515-5. MAXIMUM SQUARE FOOTAGE FOR ALL ACCESSORY STRUCTURES	
Main Building Gross Area	Maximum Total Square Footage for All Accessory Structures
1,200 square feet or less.	600 sq. ft.
Greater than 1,200 square feet.	1,000 sq. ft. or 50% of main building gross area, whichever is less.

- (e) *Landscaping.* Landscaping within the RH zone shall be provided as set forth in this subsection.
- (1) *Setbacks.* Required setbacks shall be landscaped. Landscaping shall conform to the standards set forth in SRC chapter 807.
 - (2) *Vehicle use areas.* Vehicle use areas shall be landscaped as provided under SRC chapters 806 and 807.
- (f) *Outdoor storage.* Within the RH zone, outdoor storage shall be screened from streets and adjacent properties by a minimum six-foot-high sight-obscuring fence, wall, or hedge.

Sec. 515.015. - Design review.

Design review under SRC chapter 225 is required for development within the RH as follows:

- (a) Multiple family development shall be subject to design review according to ~~the multiple family design review guidelines or the multiple family design review standards~~ set forth in SRC chapter 702.
- (b) Residential care with ~~five~~ three or more self-contained dwelling units shall be subject to design review according to ~~the multiple family design review guidelines or the multiple family design review standards~~ set forth in SRC chapter 702.

Sec. 520.015. - Uses.

- (a) *General.* Except as otherwise provided in this section, the permitted (P), special (S), conditional (C), and prohibited (N) uses in the CN zone are set forth in Table 520-1.

TABLE 520-1. USES		
Use	Status	Limitations and Qualifications
Household Living		
Single family	P	1 dwelling unit for each business use on a lot.
	N	All other single family.
Two family	P	1 dwelling unit for each business use on a lot.
	N	All other two family.
<u>Three family</u>	<u>P</u>	<u>1 dwelling unit for each business use on a lot.</u>
	<u>N</u>	<u>All other three family.</u>
<u>Four family</u>	<u>P</u>	<u>1 dwelling unit for each business use on a lot.</u>
	<u>N</u>	<u>All other four family.</u>
Multiple family	P	1 dwelling unit for each business use on a lot.
	N	All other multiple family.
Group Living		
Room and board	P	Room and board serving 5 or fewer persons.
	N	All other room and board.
Residential care	P	
Nursing care	N	
Lodging		
Short-term commercial lodging	P	Short-term rentals.
	N	All other short-term commercial lodging.
Long term commercial lodging	N	
Nonprofit shelters	P	Nonprofit shelters serving 5 or fewer persons.
	P	Nonprofit shelters serving victims of domestic violence for 10 or fewer persons.
	N	All other nonprofit shelters.
Retail Sales and Service		
Eating and drinking establishments	N	Bars and taverns, where the sale of alcohol is a primary use.
	P	All other eating and drinking establishments, subject to subsection (c) of this section.

Retail sales	P	Retail sales, subject to SRC 520.015(c).
Personal services	P	Personal services, subject to SRC 520.015(c).
Postal services and retail financial services	P	Postal and retail financial services, subject to SRC 520.015(c).
Business and Professional Services		
Office	P	Office, subject to SRC 520.015(c).
Audio/visual medial production	N	
Laboratory research and testing	P	Laboratory research and testing, subject to SRC 520.015(c).
Motor Vehicle, Trailer, and Manufactured Dwelling Sales and Service		
Motor vehicle and manufactured dwelling and trailer sales	N	
Motor vehicle services	N	
Commercial parking	N	
Park-and-ride facilities	N	
Taxicabs and car services	N	
Heavy vehicle and trailer sales	N	
Heavy vehicle and trailer service and storage	N	
Recreation, Entertainment, and Cultural Services and Facilities		
Commercial entertainment—indoor	P	The following commercial entertainment—indoor activities, subject to SRC 520.015(c): <ul style="list-style-type: none"> ■ Dance studios and schools for the instruction of children 18 years and under. ■ Membership sports and recreation clubs.
	N	All other commercial entertainment—indoor.
Commercial entertainment—outdoor	P	Membership sports and recreation clubs, subject to SRC 520.015(c).
	N	All other commercial entertainment—outdoor.
Major event entertainment	N	
Recreational and cultural community services	P	Recreational and cultural community services, subject to SRC 520.015(c).
Parks and open space	P	
Nonprofit membership assembly	P	Nonprofit membership assembly, subject to SRC 520.015(c).

Religious assembly	P	Religious assembly, subject to SRC 520.015(c).
Health Services		
Medical centers/hospitals	N	
Outpatient medical services and laboratories	P	Outpatient medical services and laboratories, subject to SRC 520. 015(c).
Education Services		
Day care	P	Day care, subject to SRC 520. 015(c).
Basic education	P	Basic education, subject to SRC 520.015(c).
Post-secondary and adult education	P	Post-secondary and adult education, subject to SRC 520.015(c).
Civic Services		
Governmental services	N	
Social services	P	Social services, subject to SRC 520.015(c).
Governmental maintenance services and construction	N	
Public Safety		
Emergency services	P	
Detention facilities	N	
Military installations	N	
Funeral and Related Services		
Cemeteries	N	
Funeral and cremation services	N	
Construction Contracting, Repair, Maintenance, and Industrial Services		
General repair services	N	
Building and grounds services and construction contracting	P	Lawn and garden services, subject to SRC 520.015(c).
	N	All other building and grounds services and construction contracting.
Cleaning plants	N	
Industrial services	N	
Wholesale Sales, Storage, and Distribution		
General wholesaling	N	
Heavy wholesaling	N	

Warehousing and distribution	N	
Self-service storage	N	
Manufacturing		
General manufacturing	N	
Heavy manufacturing	N	
Printing	N	
Transportation Facilities		
Aviation facilities	N	
Passenger ground transportation facilities	P	Transit stop shelters.
	N	All other passenger ground transportation facilities.
Marine facilities	N	
Utilities		
Basic utilities	P	
Wireless communication facilities	Allowed	Wireless communication facilities are allowed, subject to SRC chapter 703.
Drinking water treatment facilities	N	
Power generation facilities	N	
Data center facilities	N	
Fuel dealers	N	
Waste-related facilities	N	
Mining and Natural Resource Extraction		
Petroleum and natural gas production	N	
Surface mining	N	
Farming, Forestry, and Animal Services		
Agriculture	N	Marijuana production.
	P	All other agriculture.
Forestry	P	
Agriculture and forestry services	N	
Keeping of livestock and other animals	N	

Animal services	N	
Other Uses		
Temporary uses	P	Christmas tree sales, subject to SRC 701.015.
Home occupations	S	Home occupations, subject to SRC 700.020.

- (b) *Additional prohibited uses.* Notwithstanding Table 520-1, eating and drinking establishments otherwise permitted within the CN zone shall be a prohibited use within the CN zone if developed with a drive-through.
- (c) *Limitations on uses.* Where a use is allowed subject to the provisions of this subsection, the use shall conform to the following additional limitations:
- (1) Establishments under the following uses shall be limited to no more than 2,000 square feet of total floor area per establishment:
 - (A) Personal services.
 - (B) Postal services and retail financial services.
 - (C) Office.
 - (D) Laboratory research and testing.
 - (E) Outpatient medical services and laboratories.
 - (F) Building and grounds services and construction contracting.
 - (2) Establishments under the following uses shall be limited to no more than 4,000 square feet of total floor area per establishment.
 - (A) Retail sales.
 - (3) Establishments under the following uses shall be limited to no more than 5,000 square feet of total floor area per establishment.
 - (A) Eating and drinking establishments.
 - (B) Commercial entertainment—indoor.
 - (C) Commercial entertainment—outdoor.
 - (D) Recreational and cultural community services.
 - (E) Nonprofit membership assembly.
 - (F) Religious assembly.
 - (G) Day care.
 - (H) Basic education.
 - (I) Post-secondary and adult education.
 - (J) Social services.

Sec. 520.020. - Development standards.

Development within the CN zone must comply with the development standards set forth in this section.

- (a) *Lot standards.* Lots within the CN zone shall conform to the standards set forth in Table 520-2.

TABLE 520-2. LOT STANDARDS		
Requirement	Standard	Limitations & Qualifications
Lot Area		
All uses	Min. 5,000 sq. ft.	
Lot Width		
All uses	None	
Lot Depth		
All uses	Min. 80 ft.	
Street Frontage		
All uses	Min. 16 ft.	

- (b) *Setbacks.* Setbacks within the CN zone shall be provided as set forth in Tables 520-3 and 520-4.

TABLE 520-3. SETBACKS		
Requirement	Standard	Limitations & Qualifications
Abutting Street		
Buildings		
All uses	Min. 12 ft.	
Accessory structures		
Accessory to all uses	Min. 12 ft.	Not applicable to transit stop shelters.
Vehicle use areas		
All uses	Min. 12 ft.	
Interior Front		
Buildings		
Multiple family	Min. 10 ft.	Required landscaping shall meet the Type C standard set forth in SRC chapter 807.

All other uses	Zone-to-zone setback (Table 520-4)	
Accessory Structures		
Accessory to multiple family	Min. 10 ft.	Required landscaping shall meet the Type C standard set forth in SRC chapter 807.
Accessory to all other uses	Zone-to-zone setback (Table 520-4)	
Vehicle Use Areas		
Multiple family	Min. 10 ft.	Required landscaping shall meet the Type C standard set forth in SRC chapter 807.
All other uses	Zone-to-zone setback (Table 520-4)	
Interior Side		
Buildings		
Multiple family	Min. 10 ft.	Required landscaping shall meet the Type C standard set forth in SRC chapter 807.
All other uses	Zone-to-zone setback (Table 520-4)	
Accessory Structures		
Accessory to multiple family	Min. 10 ft.	Required landscaping shall meet the Type C standard set forth in SRC chapter 807.
Accessory to all other uses	Zone-to-zone setback (Table 520-4)	
Vehicle Use Areas		
Multiple family	Min. 10 ft.	Required landscaping shall meet the Type C standard set forth in SRC chapter 807.
All other uses	Zone-to-zone setback (Table 520-4)	
Interior Rear		
Buildings		
Multiple family	Min. 10 ft.	Required landscaping shall meet the Type C standard set forth in SRC chapter 807.
All other uses	Zone-to-zone setback (Table 520-4)	
Accessory Structures		

Accessory to multiple family	Min. 10 ft.	Required landscaping shall meet the Type C standard set forth in SRC chapter 807.
Accessory to all other uses	Zone-to-zone setback (Table 520-4)	
Vehicle Use Areas		
Multiple family	Min. 10 ft.	Required landscaping shall meet the Type C standard set forth in SRC chapter 807.
All other uses	Zone-to-zone setback (Table 520-4)	

TABLE 520-4. ZONE-TO-ZONE SETBACKS

Abutting Zone	Type of Improvement	Setback⁽¹⁾	Landscaping & Screening
EFU	Buildings and accessory structures	None	N/A
	Vehicle use areas	Min. 5 ft.	Type A
Residential Zone	Buildings and accessory structures	Min. 15 ft.	Type B
	Vehicle use areas		
Mixed-Use Zone	Buildings and accessory structures	None	N/A
	Vehicle use areas	Min. 5 ft.	Type A
Commercial Zone	Buildings and accessory structures	None	N/A
	Vehicle use areas	Min. 5 ft.	Type A
Public Zone	Buildings and accessory structures	None	N/A
	Vehicle use areas	Min. 5 ft.	Type A
Industrial and Employment Zone: EC, IC, IBC, and IP	Buildings and accessory structures	Min. 5 ft.	Type A
	Vehicle use areas		
Industrial and Employment Zone: IG and II	Buildings and accessory structures	Min. 10 ft.	Type C
	Vehicle use areas		

Limitations and Qualifications

- (1) Zone-to-Zone setbacks are not required abutting an alley.

- (c) *Lot coverage; height.* Buildings and accessory structures within the CN zone shall conform to the lot coverage and height standards set forth in Table 520-5.

TABLE 520-5. LOT COVERAGE; HEIGHT		
Requirement	Standard	Limitations & Qualifications
Lot Coverage		
Buildings and Accessory Structures		
All uses	Max. 50%	
Rear Yard Coverage		
Buildings		
All uses	N/A	
Accessory Structures		
Accessory to all uses	No Max.	
Height		
Buildings		
All uses	Max. 35 ft.	
Accessory Structures		
Accessory to single family, two family, <u>three family, four family,</u> and multiple family	Max. 15 ft.	
Accessory to all other uses	Max 35 ft.	

- (d) *Landscaping.*

- (1) *Setbacks.* Required setbacks shall be landscaped. Landscaping shall conform to the standards set forth in SRC chapter 807.
- (2) *Vehicle use areas.* Vehicle use areas shall be landscaped as provided under SRC chapters 806 and 807.
- (3) *Development site.* A minimum of 15 percent of the development site shall be landscaped. Landscaping shall meet the Type A standard set forth in SRC chapter 807. Other required landscaping under the UDC, such as landscaping required for setbacks or vehicle use areas, may count towards meeting this requirement.

- (e) *Outdoor storage.* Within the CN zone, outdoor storage of materials and equipment is prohibited.

- (f) *Access.* Not more than two driveway approaches serving lots within a CN district shall have direct access onto local streets.
- (g) *Hours of operation.* Except for grocery stores and eating and drinking establishments, establishments within the CN zone shall not be open for business earlier than 6:00 a.m. and shall close no later than 12:00 midnight.

Sec. 520.025. - Design review.

Design review under SRC chapter 225 is required for development within the CN as follows:

- (a) Multiple family development shall be subject to design review according to ~~the multiple family design review guidelines or the multiple family design review standards set forth in SRC chapter 702.~~
- (b) Residential Care with ~~five~~three or more self-contained dwelling units shall be subject to design review according to ~~the multiple family design review guidelines or the multiple family design review standards set forth in SRC chapter 702.~~

Sec. 521.005. - Uses.

The permitted (P), special (S), conditional (C), and prohibited (N) uses in the CO zone are set forth in Table 521-1.

TABLE 521-1. USES		
Use	Status	Limitations & Qualifications
Household Living		
Single family	P	The following single family activities: <ul style="list-style-type: none"> ■ Single family detached dwelling. ■ 1 dwelling unit for each business use on a lot. ■ Residential home, as defined under ORS 197.660.
	S	The following single family activities: <ul style="list-style-type: none"> ■ Townhouse, subject to SRC 700.085. ■ Zero side yard dwelling, subject to SRC 700.095.
	N	All other single family.
Two family	P	Duplex.
	N	All other two family.
<u>Three family</u>	<u>S</u>	<u>Subject to SRC 700.081.</u>
<u>Four family</u>	<u>S</u>	<u>Subject to SRC 700.081.</u>
Multiple family	P	
Group Living		
Room and board	P	Room and board serving 5 or fewer persons.
	C	Room and board serving 6 to 75 persons.

	N	All other room and board.
Residential care	P	
Nursing care	S	Nursing care, subject to SRC 700.045.
Lodging		
Short-term commercial lodging	P	Short-term rentals.
	N	All other short-term commercial lodging.
Long-term commercial lodging	P	
Nonprofit shelters	P	Nonprofit shelters serving 5 or fewer persons.
	C	Nonprofit shelters serving 6 to 75 persons.
	P	Nonprofit shelters serving victims of domestic violence for 10 or fewer persons.
	N	All other nonprofit shelters.
Retail Sales and Service		
Eating and drinking establishments	P	Eating places, located within buildings devoted principally to uses otherwise permitted in the CO zone, provided that not more than 25 percent of the floor area of a 1 story building, and not more than 50 percent of the floor area of a 2 or more story building, is occupied by the eating place.
	N	All other eating and drinking establishments.
Retail sales	P	The following retail sales activities: <ul style="list-style-type: none"> ■ News dealers and newsstands. ■ Caterers. ■ Retail sales of agricultural products, when the sales area does not exceed 1,000 square feet in size.
	N	All other Retail Sales.
Personal services	P	The following personal services activities are permitted: <ul style="list-style-type: none"> ■ Beauty salons. ■ Barber shops. ■ Photographic portrait studios.
	N	All other personal services.
Postal services and retail financial services	P	
Business and Professional Services		

Office	P	
Audio/visual media production	C	
Laboratory research and testing	P	
Motor Vehicle, Trailer, and Manufactured Dwelling Sales and Service		
Motor vehicle and manufactured dwelling and trailer sales	N	
Motor vehicle services	N	
Commercial parking	P	Commercial parking is permitted, unless noted below.
	N	Parking structures.
Park-and-ride facilities	P	Park-and-ride facilities are permitted, unless noted below.
	N	Parking structures.
Taxicabs and car services	N	
Heavy vehicle and trailer sales	N	
Heavy vehicle and trailer service and storage	N	
Recreation, Entertainment, and Cultural Services and Facilities		
Commercial entertainment—indoor	P	Dance studios, dance schools, yoga studios, karate instruction, and other similar physical fitness instructional activities are permitted, provided that the total building floor area of the use does not exceed 2,500 square feet.
	N	All other commercial entertainment—indoor.
Commercial entertainment—outdoor	S	Golf courses, subject to SRC 700.015.
	N	All other commercial entertainment—outdoor.
Major event entertainment	N	
Recreational and cultural community services	S	Golf courses, subject to SRC 700.015.
	P	All other recreational and cultural community services.
Parks and open space	P	
Nonprofit membership assembly	P	

Religious assembly	S	Religious assembly, subject to SRC 700.055.
Health Services		
Medical centers/hospitals	N	
Outpatient medical services and laboratories	P	
Education Services		
Day care	P	
Basic education	P	
Post-secondary and adult education	P	
Civic Services		
Governmental services	P	
Social services	P	
Governmental maintenance services and construction	N	
Public Safety		
Emergency services	P	
Detention facilities	N	
Military installations	P	
Funeral and Related Services		
Cemeteries	N	
Funeral and cremation services	P	
Construction Contracting, Repair, Maintenance, and Industrial Services		
General repair services	N	
Building and grounds services and construction contracting	N	
Cleaning plants	N	
Industrial services	N	
Wholesale Sales, Storage, and Distribution		
General wholesaling	N	

Heavy wholesaling	N	
Warehousing and distribution	N	
Self-service storage	N	
Manufacturing		
General manufacturing	N	
Heavy manufacturing	N	
Printing	N	
Transportation Facilities		
Aviation facilities	N	
Passenger ground transportation facilities	P	Transit stop shelters.
	N	All other passenger ground transportation facilities.
Marine facilities	N	
Utilities		
Basic utilities	C	Reservoirs; water storage facilities.
	P	All other basic utilities.
Wireless communication facilities	Allowed	Wireless communication facilities are allowed, subject to SRC chapter 703.
Drinking water treatment facilities	C	
Power generation facilities	C	
Data center facilities	N	
Fuel dealers	N	
Waste-related facilities	N	
Mining and Natural Resource Extraction		
Petroleum and natural gas production	N	
Surface mining	N	
Farming, Forestry, and Animal Services		
Agriculture	N	Marijuana production.
	P	All other agriculture.

Forestry	P	
Agriculture and forestry services	C	
Keeping of livestock and other animals	N	
Animal services	S	Small animal veterinary services, subject to SRC 700.075.
	N	All other animals services.
Other Uses		
Temporary uses	P	Christmas tree sales, subject to SRC 701.015.
Home occupations	S	Home occupations, subject to SRC 700.020.
Guest houses and guest quarters	P	Guest houses and guest quarters are permitted as an accessory use to single family, provided such houses and quarters are dependent upon the main building for either kitchen or bathroom facilities, or both, and are used for temporary lodging and not as a place of residence.
Taking of boarders or leasing of rooms by resident family	P	Taking of boarders or leasing of rooms by a resident family is permitted as an accessory use to household living, provided the total number of boarders and roomers does not exceed 2 in any dwelling unit.
Storage of commercial vehicle as an accessory use to household living	P	Storage of a commercial vehicle as an accessory use to household living is permitted, provided no more than 1 commercial vehicle is stored per dwelling unit.
Historic resource adaptive reuse pursuant to SRC chapter 230	Allowed	Historic resource adaptive reuse pursuant to SRC chapter 230 is allowed, subject to SRC 230.085.
Accessory dwelling units	S	Accessory dwelling units, subject to SRC 700.007.

Sec. 521.010. - Development standards.

Development within the CO zone must comply with the development standards set forth in this section.

- (a) *Lot standards.* Lots within the CO zone shall conform to the standards set forth in Table 521-2.

TABLE 521-2. LOT STANDARDS		
Requirement	Standard	Limitations & Qualifications

Lot Area		
Single family	Min. 4,000 sq. ft.	
Two family, <u>three family, and four family</u>	Min. 5,000 sq. ft., plus additional lot area based on number of bedrooms within each dwelling unit	Additional lot area required as follows: <ul style="list-style-type: none"> ■ 750 sq. ft. for each dwelling unit with 1 bedroom. ■ 1,000 sq. ft. for each dwelling unit with 2 bedrooms. ■ 1,200 sq. ft. for each dwelling unit with 3 or more bedrooms.
Multiple family	Min. 5,000 sq. ft., plus additional lot area based on number of bedrooms within each dwelling unit	Applicable to multiple family consisting of 5 or fewer dwelling units. Additional lot area required as follows: <ul style="list-style-type: none"> ■ 750 sq. ft. for each dwelling unit with 1 bedroom. ■ 1,000 sq. ft. for each dwelling unit with 2 bedrooms. ■ 1,200 sq. ft. for each dwelling unit with 3 to 5 bedrooms.
	Min. 5,000 sq. ft., plus additional lot area based on number of bedrooms within each dwelling unit	Applicable to multiple family consisting of 6 or more dwelling units. Additional lot area required as follows: First through fifth dwelling units. <ul style="list-style-type: none"> ■ 750 sq. ft. for each dwelling unit with 1 bedroom. ■ 1,000 sq. ft. for each dwelling unit with 2 bedrooms. ■ 1,200 sq. ft. for each dwelling unit with 3 to 5 bedrooms. Sixth and additional dwelling units. <ul style="list-style-type: none"> ■ 1,000 sq. ft. for each dwelling unit with no more than 2 bedrooms in a 2 or more story structure. ■ 1,250 sq. ft. for each dwelling unit with no more than 2 bedrooms in a 1 story structure. ■ 1,700 sq. ft. for each dwelling unit with 3 or more bedrooms.
All other uses	Min. 6,000 sq. ft.	
Lot Width		
Single family, two family, <u>three family,</u>	Min. 40 ft.	

<u>four family, and multiple family</u>		
All other uses	None	
Lot Depth		
Single family	Min. 70 ft.	
	Max. 300% of average lot width	
<u>Two family, three family, four family, and multiple family</u>	Min. 80 ft.	
All other uses	None	
Street Frontage		
Single family	Min. 40 ft.	
	Min. 30 ft.	Applicable to lots fronting on the turnaround of a cul-de-sac street or the outside curve of a curved street having a radius of 200 feet or less and a direction change of 60 degrees or more. In no case shall the lot width be less than 40 ft. at the front building setback line.
All other uses	Min. 16 ft.	

(b) *Setbacks.* Setbacks within the CO zone shall be provided as set forth in Tables 521-3 and 521-4.

TABLE 521-3. SETBACKS		
Requirement	Standard	Limitations & Qualifications
Abutting Street		
Buildings		
All uses	Min. 12 ft.	
Accessory Structures		
Accessory to single family, two family, <u>three family, four family,</u> and multiple family	None	Applicable to accessory structures not more than 4 ft. in height.
	Min. 12 ft.	Applicable to accessory structures greater than 4 ft. in height.
Accessory to all other uses	Min. 12 ft.	Not applicable to transit stop shelters.

Vehicle Use Areas		
All uses, other than single family, and two family, <u>three family, and four family</u>	Min. 12 ft.	
Interior Front		
Buildings		
Single family, and two family, <u>three family, and four family</u>	Min. 5 ft.	
Multiple family	Min. 10 ft.	Required landscaping shall meet the Type C standard set forth in SRC chapter 807.
All other uses	Zone-to-zone setback (Table 521-4)	
Accessory Structures		
Accessory to single family, and two family, <u>three family, and four family</u>	Min. 5 ft.	
Accessory to multiple family	Min. 10 ft.	Required landscaping shall meet the Type C standard set forth in SRC chapter 807.
Accessory to all other uses	Zone-to-zone setback (Table 521-4)	
Vehicle Use Areas		
Single family and two family, <u>three family, and four family</u>	Per SRC chapter 806	
Multiple family	Min. 10 ft.	Required landscaping shall meet the Type C standard set forth in SRC chapter 807.
All other uses	Zone-to-zone setback (Table 521-4)	
Interior Side		
Buildings		
Single family	Min. 5 ft.	Applicable to buildings, other than townhouses and zero side yard dwellings.
	Per SRC 700.085	Applicable to townhouses.
	Per SRC 700.095	Applicable to zero side yard dwellings.

Two family, <u>three family, and four family</u>	Min. 5 ft.	
Multiple family	Min. 10 ft.	Required landscaping shall meet the Type C standard set forth in SRC chapter 807.
All other uses	Zone-to-zone setback (Table 521-4)	
Accessory Structures		
Accessory to single family, <u>and two family, three family, and four family</u>	None	Applicable to accessory structures having at least 1 wall which is an integral part of a fence.
	Min. 5 ft.	Applicable to all other accessory structures.
Accessory to multiple family	Min. 10 ft.	Required landscaping shall meet the Type C standard set forth in SRC chapter 807.
Accessory to all other uses	Zone-to-zone setback (Table 521-4)	
Vehicle Use Areas		
Single family, <u>and two family, three family, and four family</u>	Per SRC chapter 806	
Multiple family	Min. 10 ft.	Required landscaping shall meet the Type C standard set forth in SRC chapter 807.
All other uses	Zone-to-zone setback (Table 521-4)	
Interior Rear		
Buildings		
Single family, <u>and two family, three family, and four family</u>	Min. 5 ft.	
Multiple family	Min. 10 ft.	Required landscaping shall meet the Type C standard set forth in SRC chapter 807.
All other uses	Zone-to-zone setback (Table 521-4)	
Accessory Structures		
	None	Applicable to accessory structures not more than 9 ft. in height.

Accessory to single family, and two family, three family, <u>and four family</u>	Min. 1 ft. for each 1 ft. of height over 9 ft.	Applicable to accessory structures greater than 9 ft. in height.
	Min. 1 ft.	Applicable to accessory structures adjacent to an alley, unless a greater setback is required based on the height of the accessory structure.
Accessory to multiple family	Min. 10 ft.	Required landscaping shall meet the Type C standard set forth in SRC chapter 807.
Accessory to all other uses	Zone-to-zone setback (Table 521-4)	
Vehicle Use Areas		
Single family, and two family, three family, <u>and four family</u>	Per SRC chapter 806	
Multiple family	Min. 10 ft.	Required landscaping shall meet the Type C standard set forth in SRC chapter 807.
All other uses	Zone-to-zone setback (Table 521-4)	

TABLE 521-4. ZONE-TO-ZONE SETBACKS			
Abutting Zone	Type of Improvement	Setback (1)	Landscaping & Screening
EFU	Buildings and accessory structures	None	N/A
	Vehicle use areas	Min. 5 ft.	Type A
Residential Zone	Buildings and accessory structures	Min. 15 ft.	Type C
	Vehicle use areas		
Mixed-Use Zone	Buildings and accessory structures	None	N/A
	Vehicle use areas	Min. 5 ft.	Type A
Commercial Zone	Buildings and accessory structures	None	N/A

	Vehicle use areas	Min. 5 ft.	Type A
Public Zone	Buildings and accessory structures	None	N/A
	Vehicle use areas	Min. 5 ft.	Type A
Industrial and Employment Zone: EC, IC, IBC, and IP	Buildings and accessory structures	Min. 5 ft.	Type A
	Vehicle use areas		
Industrial and Employment Zone: IG and II	Buildings and accessory structures	Min. 10 ft.	Type C
	Vehicle use areas		
Limitations and Qualifications ⁽¹⁾ Zone-to-Zone setbacks are not required abutting an alley.			

(c) *Lot coverage; height.* Buildings and accessory structures within the CO zone shall conform to the lot coverage and height standards set forth in Table 521-5.

TABLE 521-5. LOT COVERAGE; HEIGHT		
Requirement	Standard	Limitations & Qualifications
Lot Coverage		
Buildings and Accessory Structures		
All uses	Max. 60%	
Rear Yard Coverage		
Buildings		
All uses	N/A	
Accessory Structures		
Accessory to all uses	No Max.	
Height		
Buildings		
Single family, and two family, <u>three family, and four family</u>	Max. 35 ft.	
Multiple family and long-term commercial lodging	Max. 50 ft.	

All other uses	Max. 70 ft.	
Accessory Structures		
Accessory to single family, two family, <u>three family, four family,</u> and multiple family	Max. 15 ft.	
Accessory to all other uses	Max 70 ft.	

(d) *Landscaping.*

- (1) *Setbacks.* Required setbacks shall be landscaped. Landscaping shall conform to the standards set forth in SRC chapter 807.
- (2) *Vehicle use areas.* Vehicle use areas shall be landscaped as provided under SRC chapters 806 and 807.
- (3) *Development site.* A minimum of 15 percent of the development site shall be landscaped. Landscaping shall meet the Type A standard set forth in SRC chapter 807. Other required landscaping under the UDC, such as landscaping required for setbacks or vehicle use areas, may count towards meeting this requirement.

- (e) *Outdoor storage.* Within the CO zone, outdoor storage of materials and equipment is prohibited, except in conjunction with residential uses where the storage is screened from adjacent streets and properties by a sight-obscuring fence, wall, or hedge.

Sec. 521.015. - Design review.

Design review under SRC chapter 225 is required for development within the CO as follows:

- (a) Multiple family development shall be subject to design review according to ~~the multiple family design review guidelines~~ or the multiple family design review standards set forth in SRC chapter 702.
- (b) Residential care with ~~five~~three or more self-contained dwelling units shall be subject to ~~design review according to the multiple family design review guidelines~~ or the multiple family design review standards set forth in SRC chapter 702.

Sec. 522.005. - Uses.

- (a) Except as otherwise provided in this section, the permitted (P), special (S), conditional (C), and prohibited (N) uses in the CR zone are set forth in Table 522-1.

TABLE 522-1. USES		
Use	Status	Limitations & Qualifications
Household Living		
Single family	P	Residential home, as defined under ORS 197.660, within an existing single family dwelling allowed as a continued use pursuant to SRC 522.005(b).

	S	Secondary dwellings and guest rooms, subject to SRC 700.070.
	N	All other single family.
Two family	N	
<u>Three family</u>	<u>S</u>	<u>Subject to SRC 700.081.</u>
<u>Four family</u>	<u>S</u>	<u>Subject to SRC 700.081.</u>
Multiple family	C	
Group Living		
Room and board	P	Room and board serving 5 or fewer persons.
	C	Room and board serving 6 to 75 persons.
	N	All other room and board.
Residential care	P	
Nursing care	P	
Lodging		
Short-term commercial lodging	P	
Long-term commercial lodging	C	
Nonprofit shelters	P	Nonprofit shelters serving 5 or fewer persons.
	C	Nonprofit shelters serving 6 to 75 persons.
	P	Nonprofit shelters serving victims of domestic violence for 10 or fewer persons.
	N	All other nonprofit shelters.
Retail Sales and Service		
Eating and drinking establishments	P	
Retail sales	N	Used merchandise stores, where sales and storage of merchandise and equipment is not conducted entirely within a building.
	P	All other retail sales.
Personal services	P	
Postal services and retail financial services	P	
Business and Professional Services		

Office	P	
Audio/visual media production	P	
Laboratory research and testing	P	
Motor Vehicle, Trailer, and Manufactured Dwelling Sales and Service		
Motor vehicle and manufactured dwelling and trailer sales	C	
Motor vehicle services	P	Gasoline service stations.
	C	All other motor vehicle services.
Commercial parking	P	
Park-and-ride facilities	P	
Taxicabs and car services	P	
Heavy vehicle and trailer sales	C	Truck rental and leasing.
	N	All other heavy vehicle and trailer sales.
Heavy vehicle and trailer service and storage	P	Truck stops.
	C	The following heavy vehicle and trailer service and storage activities: <ul style="list-style-type: none"> ■ Heavy vehicle and equipment operation instruction. ■ Tire retreading and tire repair shops.
	N	All other heavy vehicle and trailer service and storage.
Recreation, Entertainment, and Cultural Services and Facilities		
Commercial entertainment—indoor	C	Nightclubs, located within 200 feet of a residential zone.
	P	All other commercial entertainment—indoor.
Commercial entertainment—outdoor	C	Privately owned camps, campgrounds, and recreational vehicle parks.
	N	The following commercial entertainment—outdoor activities: <ul style="list-style-type: none"> ■ Amusement parks. ■ Drive-in movie theaters.
	P	All other commercial entertainment—outdoor.
Major event entertainment	C	

Recreational and cultural community services	P	
Parks and open space	P	
Nonprofit membership assembly	P	
Religious assembly	P	
Health Services		
Medical centers/hospitals	N	
Outpatient medical services and laboratories	P	
Education Services		
Day care	P	
Basic education	P	
Post-secondary and adult education	P	
Civic Services		
Governmental services	P	
Social services	P	
Governmental maintenance services and construction	N	
Public Safety		
Emergency services	P	
Detention facilities	N	
Military Installations	P	
Funeral and Related Services		
Cemeteries	N	
Funeral and cremation services	P	
Construction Contracting, Repair, Maintenance, and Industrial Services		
General repair services	P	
	P	The following buildings and grounds services and construction contracting activities:

Building and grounds services and construction contracting		<ul style="list-style-type: none"> ■ Landscape, lawn, and garden services. ■ Tree and shrub services.
	C	Carpet and upholstery cleaning establishments.
	N	All other building and grounds services and construction contracting.
Cleaning plants	N	
Industrial services	P	
Wholesale Sales, Storage, and Distribution		
General wholesaling	N	
Heavy wholesaling	N	
Warehousing and distribution	C	Distribution centers for online, mail order, and catalog sales.
	N	All other warehousing and distribution.
Self-service storage	N	
Manufacturing		
General manufacturing	P	General manufacturing, provided the manufacturing does not exceed 10,000 square feet of total floor area per development site and retail sales of the products manufactured is provided on-site.
	C	<p>The following general manufacturing activities, when exceeding 10,000 square feet of total floor area per development site:</p> <ul style="list-style-type: none"> ■ Industrial and institutional food service contractors. ■ Costume jewelry and precious metals metalsmithing. ■ Sundries and notions. ■ Signs.
	N	All other general manufacturing.
Heavy manufacturing	N	
Printing	P	
Transportation Facilities		
Aviation facilities	N	
Passenger ground transportation facilities	P	Transit stop shelters.
	C	<p>The following passenger ground transportation facilities:</p> <ul style="list-style-type: none"> ■ Local and suburban passenger transportation. ■ Intercity and rural highway passenger transportation within 2,000 feet from the center point of an I-5

		interchange and having direct access on to a major arterial.
	N	All other passenger ground transportation facilities.
Marine facilities	N	
Utilities		
Basic utilities	C	Reservoirs; water storage facilities.
	P	All other basic utilities.
Wireless communication facilities	Allowed	Wireless communication facilities are allowed, subject to SRC chapter 703.
Drinking water treatment facilities	C	
Power generation facilities	C	
Data center facilities	N	
Fuel dealers	N	
Waste-related facilities	C	The following waste-related facilities are allowed conditionally: <ul style="list-style-type: none"> ■ Recycling depots. ■ Solid waste transfer stations.
	N	All other waste-related facilities.
Mining and Natural Resource Extraction		
Petroleum and natural gas production	N	
Surface mining	N	
Farming, Forestry, and Animal Services		
Agriculture	N	Marijuana production.
	P	All other agriculture.
Forestry	P	
Agriculture and forestry services	P	
Keeping of livestock and other animals	N	
Animal services	N	New wildlife rehabilitation facility.
	P	All other animal services.
Other Uses		

Temporary uses	P	The following temporary uses: <ul style="list-style-type: none"> ■ Temporary motor vehicle and recreational vehicle sales, subject to SRC 701.035.
Home occupations	S	Home occupations, subject to SRC 700.020.
Accessory dwelling units	S	Accessory dwelling units, subject to SRC 700.007.

(b) Continued uses. Existing single family and two family uses , other than manufactured dwellings, within the CR zone constructed prior to February 1, 1983, but which would otherwise be made nonconforming by this chapter, are hereby deemed continued uses.

- (1) Building or structures housing a continued use may be structurally altered or enlarged, or rebuilt following damage or destruction, provided such alteration, enlargement, or rebuilding complies with the standards set forth in SRC 522.010(e).
- (2) Cease of occupancy of a building or structure for a continued use shall not preclude future use of the building or structure for a residential use; provided, however, conversion of the building or structure to a nonresidential use shall thereafter prevent conversion back to a residential use.

Sec. 522.010. - Development standards.

Development within the CR zone must comply with the development standards set forth in this section.

- (a) *Lot standards.* Lots within the CR zone shall conform to the standards set forth in Table 522-2.

TABLE 522-2. LOT STANDARDS		
Requirement	Standard	Limitations & Qualifications
Lot Area		
All uses	None	
Lot Width		
All uses	None	
Lot Depth		
All uses	None	
Street Frontage		
Single family	Min. 40 ft.	
	Min. 30 ft.	Applicable to lots fronting on the turnaround of a cul-de-sac street or the outside curve of a curved street having a radius of 200 feet or less and a direction change of 60 degrees or more. In no case shall the lot width be less than 40 ft. at the front building setback line.

All other uses	Min. 16 ft.	
----------------	-------------	--

(b) *Setbacks.* Setbacks within the CR zone shall be provided as set forth in Tables 522-3 and 522-4.

TABLE 522-3. SETBACKS		
Requirement	Standard	Limitations & Qualifications
Abutting Street		
Buildings		
All uses	Min. 5 ft.	
Accessory Structures		
Accessory to single family, <u>three family, four family,</u> and multiple family	None	Applicable to accessory structures not more than 4 ft. in height.
	Min. 5 ft.	Applicable to accessory structures greater than 4 ft. in height.
Accessory to all other uses	Min. 5 ft.	Not applicable to transit stop shelters.
Vehicle Use Areas		
All uses	Per SRC chapter 806	
Interior Front		
Buildings		
Single family, <u>three family,</u> and <u>four family</u>	None	
Multiple family	Min. 10 ft.	Required landscaping shall meet the Type C standard set forth in SRC chapter 807.
All other uses	Zone-to-zone setback (Table 522-4)	
Accessory Structures		
Accessory to single family, <u>three family,</u> and <u>four family</u>	Min. 5 ft.	
Accessory to multiple family	Min. 10 ft.	Required landscaping shall meet the Type C standard set forth in SRC chapter 807.
Accessory to all other uses	Zone-to-zone setback (Table 522-4)	

Vehicle Use Areas		
Multiple family	Min. 10 ft.	Required landscaping shall meet the Type C standard set forth in SRC chapter 807.
All other uses	Zone-to-zone setback (Table 522-4)	
Interior Side		
Buildings		
Single family	None	
<u>Three family and four family</u>	<u>Min. 5 ft.</u>	
Multiple family	Min. 10 ft.	Required landscaping shall meet the Type C standard set forth in SRC chapter 807.
All other uses	Zone-to-zone setback (Table 522-4)	
Accessory Structures		
<u>Accessory to single family, three family, and four family</u>	None	Applicable to accessory structures having at least 1 wall which is an integral part of a fence.
	Min. 5 ft.	Applicable to all other accessory structures.
Accessory to multiple family	Min. 10 ft.	Required landscaping shall meet the Type C standard set forth in SRC chapter 807.
Accessory to all other uses	Zone-to-zone setback (Table 522-4)	
Vehicle Use Areas		
Multiple family	Min. 10 ft.	Required landscaping shall meet the Type C standard set forth in SRC chapter 807.
All other uses	Zone-to-zone setback (Table 522-4)	
Interior Rear		
Buildings		
Single family	None	
<u>Three family and four family</u>	<u>Min. 5 ft.</u>	

Multiple family	Min. 10 ft.	Required landscaping shall meet the Type C standard set forth in SRC chapter 807.
All other uses	Zone-to-zone setback (Table 522-4)	
Accessory Structures		
Accessory to single family, three family, and four family	None	Applicable to accessory structures not more than 9 ft. in height.
	Min. 1 ft. for each 1 ft. of height over 9 ft.	Applicable to accessory structures greater than 9 ft. in height.
	Min. 1 ft.	Applicable to accessory structures adjacent to an alley, unless a greater setback is required based on the height of the accessory structure.
Accessory to multiple family	Min. 10 ft.	Required landscaping shall meet the Type C standard set forth in SRC chapter 807.
Accessory to all other uses	Zone-to-zone setback (Table 522-4)	
Vehicle Use Areas		
Multiple family	Min. 10 ft.	Required landscaping shall meet the Type C standard set forth in SRC chapter 807.
All other uses	Zone-to-zone setback (Table 522-4)	

TABLE 522-4. ZONE-TO-ZONE SETBACKS			
Abutting Zone	Type of Improvement	Setback (1)	Landscaping & Screening
EFU	Buildings and accessory structures	None	N/A
	Vehicle use areas	Min. 5 ft.	Type A
Residential Zone	Buildings and accessory structures	Min. 15 ft.	Type C
	Vehicle use areas		

Mixed-Use Zone	Buildings and accessory structures	None	N/A
	Vehicle use areas	Min. 5 ft.	Type A
Commercial Zone	Buildings and accessory structures	None	N/A
	Vehicle use areas	Min. 5 ft.	Type A
Public Zone	Buildings and accessory structures	None	N/A
	Vehicle use areas	Min. 5 ft.	Type A
Industrial and Employment Zone: EC, IC, IBC, and IP	Buildings and accessory structures	Min. 5 ft.	Type A
	Vehicle use areas		
Industrial and Employment Zone: IG and II	Buildings and accessory structures	Min. 10 ft.	Type C
	Vehicle use areas		
Limitations and qualifications: ⁽¹⁾ Zone-to-Zone setbacks are not required abutting an alley.			

(c) *Lot coverage; height.* Buildings and accessory structures within the CR zone shall conform to the lot coverage and height standards set forth in Table 522-5.

TABLE 522-5. LOT COVERAGE; HEIGHT		
Requirement	Standard	Limitations & Qualifications
Lot Coverage		
Buildings and Accessory Structures		
All uses	No Max.	
Rear Yard Coverage		
Buildings		
All uses	N/A	
Accessory Structures		
Accessory to all uses	No Max.	
Height		
Buildings		

All uses	Max. 50 ft.	
Accessory Structures		
Accessory to single family, <u>three family, four family,</u> and multiple family	Max. 15 ft.	
Accessory to all other uses	Max. 50 ft.	

(d) *Landscaping.*

- (1) *Setbacks.* Required setbacks shall be landscaped. Landscaping shall conform to the standards set forth in SRC chapter 807.
- (2) *Vehicle use areas.* Vehicle use areas shall be landscaped as provided under SRC chapters 806 and 807.
- (3) *Development site.* A minimum of 15 percent of the development site shall be landscaped. Landscaping shall meet the Type A standard set forth in SRC chapter 807. Other required landscaping under the UDC, such as landscaping required for setbacks or vehicle use areas, may count towards meeting this requirement.

(e) *Development standards for continued uses.*

- (1) *Buildings.* Buildings housing a continued use may be structurally altered or enlarged, or rebuilt following damage or destruction, provided such alteration, enlargement, or rebuilding conforms to development standards of the Single Family Residential (RS) Zone set forth in SRC chapter 511 and to all other applicable provisions of the UDC, except for lot size and dimension standards in SRC chapter 511.
- (2) *Accessory structures.* Existing accessory structures to a continued use may be structurally altered or enlarged, or rebuilt following damage or destruction, and new accessory structures to a continued use may be constructed, provided such alteration, enlargement, rebuilding, or new accessory structure construction conforms to the development standards of the Single Family Residential (RS) Zone set forth in SRC chapter 511, except the lot size and dimensions standards, and to all other applicable provisions of the UDC.
- (3) *Option to rebuild in same location.* Notwithstanding SRC 522.010(e)(1) and (2), any building or accessory structure rebuilt following damage or destruction may either be located on the same location on the lot as the original building or structure, or in compliance with the setbacks of the Single Family Residential (RS) Zone set forth in SRC 511.010(b).

Sec. 522.015. - Design review.

Design review under SRC chapter 225 is required for development within the CR as follows:

- (a) Multiple family development shall be subject to design review according to ~~the multiple family design review guidelines or~~ the multiple family design review standards set forth in SRC chapter 702.
- (b) Residential care with ~~five~~three or more self-contained dwelling units shall be subject to design review according to ~~the multiple family design review guidelines or~~ the multiple family design review standards set forth in SRC chapter 702.

Sec. 523.005. - Uses.

- (a) Except as otherwise provided in this section, the permitted (P), special (S), conditional (C), and prohibited (N) uses in the CG zone are set forth in Table 523-1.

TABLE 523-1. USES		
Use	Status	Limitations & Qualifications
Household Living		
Single family	P	Residential home, as defined under ORS 197.660, within an existing single family dwelling allowed as a continued use pursuant to subsection (b) of this section.
	N	All other single family.
Two family	N	
<u>Three family</u>	<u>S</u>	<u>Subject to SRC 700.081.</u>
<u>Four family</u>	<u>S</u>	<u>Subject to SRC 700.081.</u>
Multiple family	C	
Group Living		
Room and board	P	Room and board serving 5 or fewer persons.
	C	Room and board serving 6 to 75 persons.
	N	All other room and board.
Residential care	C	
Nursing care	P	
Lodging		
Short-term commercial lodging	P	
Long- term commercial lodging	P	
Nonprofit shelters	P	Nonprofit shelters serving 5 or fewer persons.
	C	Nonprofit shelters serving 6 to 75 persons.

	P	Nonprofit shelters serving victims of domestic violence for 10 or fewer persons.
	N	All other nonprofit shelters.
Retail Sales and Service		
Eating and drinking establishments	P	
Retail sales	N	Used merchandise stores, where sales and storage of merchandise and equipment is not conducted entirely within a building or within a yard fully enclosed by a sight-obscuring fence, wall, or hedge.
	P	All other retail sales.
Personal services	P	
Postal services and retail financial services	P	
Business and Professional Services		
Office	P	
Audio/visual media production	P	
Laboratory research and testing	P	
Motor Vehicle, Trailer, and Manufactured Dwelling Sales and Service		
Motor vehicle and manufactured dwelling and trailer sales	P	
Motor vehicle services	P	
Commercial parking	P	
Park-and-ride facilities	P	
Taxicabs and car services	P	
Heavy vehicle and trailer sales	P	
Heavy vehicle and trailer service and storage	P	
Recreation, Entertainment, and Cultural Services and Facilities		

Commercial entertainment— indoor	C	Nightclubs, located within 200 feet of a residential zone.
	P	All other commercial entertainment—indoor.
Commercial entertainment— outdoor	C	Drive-in movie theaters.
	P	All other commercial entertainment—outdoor.
Major event entertainment	C	Race tracks.
	P	All other major event entertainment.
Recreational and cultural community services	P	
Parks and open space	P	
Nonprofit membership assembly	P	
Religious assembly	P	
Health Services		
Medical centers/hospitals	N	
Outpatient medical services and laboratories	P	
Education Services		
Day care	P	
Basic education	P	
Post-secondary and adult education	P	
Civic Services		
Governmental services	P	
Social services	P	
Governmental maintenance services and construction	N	
Public Safety		
Emergency services	P	
Detention facilities	N	
Military Installations	P	
Funeral and Related Services		

Cemeteries	N	
Funeral and cremation services	P	
Construction Contracting, Repair, Maintenance, and Industrial Services		
General repair services	P	
Building and grounds services and construction contracting	P	
Cleaning plants	P	
Industrial services	P	
Wholesale Sales, Storage, and Distribution		
General wholesaling	P	
Heavy wholesaling	P	The following heavy wholesaling activities: <ul style="list-style-type: none"> ■ Nursery stock wholesalers. ■ Tractor and farm equipment wholesalers.
	C	The following heavy wholesaling activities: <ul style="list-style-type: none"> ■ Firearms wholesalers. ■ Wood products and timber wholesalers.
	N	All other heavy wholesaling.
Warehousing and distribution	P	The following warehousing and distribution activities: <ul style="list-style-type: none"> ■ Distribution centers for online, mail order, and catalog sales. ■ Postal processing and distribution centers.
	N	All other warehousing and distribution.
Self-service storage	N	
Manufacturing		
General manufacturing	P	General manufacturing, provided the manufacturing does not exceed 10,000 square feet of total floor area per development site and retail sales of the products manufactured is provided on-site.
	C	The following general manufacturing activities, when exceeding 10,000 square feet of total floor area per development site: <ul style="list-style-type: none"> ■ Industrial and institutional food service contractors. ■ Costume jewelry and precious metals metalsmithing. ■ Sundries and notions. ■ Signs.

	N	All other general manufacturing.
Heavy manufacturing	N	
Printing	P	
Transportation Facilities		
Aviation facilities	N	
Passenger ground transportation facilities	P	
Marine facilities	N	
Utilities		
Basic utilities	C	Reservoirs; water storage facilities.
	P	All other basic utilities.
Wireless communication facilities	Allowed	Wireless communication facilities are allowed, subject to SRC chapter 703.
Drinking water treatment facilities	C	
Power generation facilities	C	
Data center facilities	N	
Fuel dealers	P	
Waste-related facilities	P	Recycling depots.
	C	Solid waste transfer stations.
	N	All other waste-related facilities.
Mining and Natural Resource Extraction		
Petroleum and natural gas production	N	
Surface mining	N	
Farming, Forestry, and Animal Services		
Agriculture	C	Marijuana production, when conducted indoors with an air filtration system to minimize odor impacts upon neighboring properties.
	P	All other agriculture.
Forestry	P	
Agriculture and forestry services	P	

Keeping of livestock and other animals	C	
Animal services	C	Wildlife rehabilitation facilities.
	P	All other animal services.
Other Uses		
Temporary uses	P	The following temporary uses: ■ Temporary motor vehicle and recreational vehicle sales, subject to SRC 701.035.
Home occupations	S	Home occupations, subject to SRC 700.020.
Accessory dwelling units	S	Accessory dwelling units, subject to SRC 700.007.

- (b) Continued uses. Existing single family and two family uses , other than manufactured dwellings, within the CG zone constructed prior to February 1, 1983, but which would otherwise be made nonconforming by this chapter, are hereby deemed continued uses.
- (1) Building or structures housing a continued use may be structurally altered or enlarged, or rebuilt following damage or destruction, provided such alteration, enlargement, or rebuilding complies with the standards set forth in SRC 523.010(e).
 - (2) Cease of occupancy of a building or structure for a continued use shall not preclude future use of the building or structure for a residential use; provided, however, conversion of the building or structure to a nonresidential use shall thereafter prevent conversion back to a residential use.

Sec. 523.010. - Development standards.

Development within the CG zone must comply with the development standards set forth in this section.

- (a) *Lot standards.* Lots within the CG zone shall conform to the standards set forth in Table 523-2.

TABLE 523-2. LOT STANDARDS		
Requirement	Standard	Limitations & Qualifications
Lot Area		
All uses	None	
Lot Width		
All uses	None	
Lot Depth		
All uses	None	

Street Frontage		
Single family	Min. 40 ft.	
	Min. 30 ft.	Applicable to lots fronting on the turnaround of a cul-de-sac street or the outside curve of a curved street having a radius of 200 feet or less and a direction change of 60 degrees or more. In no case shall the lot width be less than 40 ft. at the front building setback line.
All other uses	Min. 16 ft.	

(b) *Setbacks.* Setbacks within the CG zone shall be provided as set forth in Tables 523-3 and 523-4.

TABLE 523-3. SETBACKS		
Requirement	Standard	Limitations & Qualifications
Abutting Street		
Buildings		
All uses	Min. 5 ft.	
Accessory Structures		
Accessory to single family, <u>three family, four family,</u> and multiple family	None	Applicable to accessory structures not more than 4 ft. in height.
	Min. 5 ft.	Applicable to accessory structures greater than 4 ft. in height.
Accessory to all other uses	Min. 5 ft.	Not applicable to transit stop shelters.
Vehicle Use Areas		
All uses	Per SRC chapter 806	
Interior Front		
Buildings		
Single family, <u>three family,</u> and <u>four family</u>	None	
Multiple family	Min. 10 ft.	Required landscaping shall meet the Type C standard set forth in SRC chapter 807.
All other uses	Zone-to-zone setback (Table 523-4)	
Accessory Structures		

Accessory to single family, <u>three family, and four family</u>	Min. 5 ft.	
Accessory to multiple family	Min. 10 ft.	Required landscaping shall meet the Type C standard set forth in SRC chapter 807.
Accessory to all other uses	Zone-to-zone setback (Table 523-4)	
Vehicle Use Areas		
Multiple family	Min. 10 ft.	Required landscaping shall meet the Type C standard set forth in SRC chapter 807.
All other uses	Zone-to-zone setback (Table 523-4)	
Interior Side		
Buildings		
Single family	None	
<u>Three family and four family</u>	<u>Min. 5 ft.</u>	
Multiple family	Min. 10 ft.	Required landscaping shall meet the Type C standard set forth in SRC chapter 807.
All other uses	Zone-to-zone setback (Table 523-4)	
Accessory Structures		
Accessory to single family, <u>three family, and four family</u>	None	Applicable to accessory structures having at least 1 wall which is an integral part of a fence.
	Min. 5 ft.	Applicable to all other accessory structures.
Accessory to multiple family	Min. 10 ft.	Required landscaping shall meet the Type C standard set forth in SRC chapter 807.
Accessory to all other uses	Zone-to-zone setback (Table 523-4)	
Vehicle Use Areas		
Multiple family	Min. 10 ft.	Required landscaping shall meet the Type C standard set forth in SRC chapter 807.

All other uses	Zone-to-zone setback (Table 823-4)	
Interior Rear		
Buildings		
Single family, <u>three family,</u> <u>and four family</u>	None	
Multiple family	Min. 10 ft.	Required landscaping shall meet the Type C standard set forth in SRC chapter 807.
All other uses	Zone-to-zone setback (Table 523-4)	
Accessory Structures		
Accessory to single family, <u>three family,</u> <u>and four family</u>	None	Applicable to accessory structures not more than 9 ft. in height.
	Min. 1 ft. for each 1 ft. of height over 9 ft.	Applicable to accessory structures greater than 9 ft. in height.
	Min. 1 ft.	Applicable to accessory structures adjacent to an alley, unless a greater setback is required based on the height of the accessory structure.
Accessory to multiple family	Min. 10 ft.	Required landscaping shall meet the Type C standard set forth in SRC chapter 807.
Accessory to all other uses	Zone-to-zone setback (Table 523-4)	
Vehicle Use Areas		
Multiple family	Min. 10 ft.	Required landscaping shall meet the Type C standard set forth in SRC chapter 807.
All other uses	Zone-to-zone setback (Table 523-4)	

TABLE 523-4. ZONE-TO-ZONE SETBACKS

Abutting Zone	Type of Improvement	Setback (1)	Landscaping & Screening
EFU	Buildings and accessory structures	None	N/A
	Vehicle use areas	Min. 5 ft.	Type A
Residential Zone	Buildings and accessory structures	Min. 15 ft.	Type C
	Vehicle use areas		
Mixed-Use Zone	Buildings and accessory structures	None	N/A
	Vehicle use areas	Min. 5 ft.	Type A
Commercial Zone	Buildings and accessory structures	None	N/A
	Vehicle use areas	Min. 5 ft.	Type A
Public Zone	Buildings and accessory structures	None	N/A
	Vehicle use areas	Min. 5 ft.	Type A
Industrial and Employment Zone: EC, IC, IBC, and IP	Buildings and accessory structures	Min. 5 ft.	Type A
	Vehicle use areas		Industrial and Employment Zone:
IG and II	Buildings and accessory structures	Min. 10 ft.	Type C
	Vehicle use areas		
Limitations and qualifications: (1) Zone-to-Zone setbacks are not required abutting an alley.			

(c) *Lot coverage; height.* Buildings and accessory structures within the CG zone shall conform to the lot coverage and height standards set forth in Table 523-5.

TABLE 523-5. LOT COVERAGE; HEIGHT		
Requirement	Standard	Limitations & Qualifications

Lot Coverage		
Buildings and accessory structures		
All uses	No Max.	
Rear Yard Coverage		
Buildings		
All uses	N/A	
Accessory Structures		
Accessory to all uses	No Max.	
Height		
Buildings		
All uses	Max. 70 ft.	
Accessory Structures		
Accessory to single family, <u>three family, four family,</u> and multiple family	Max. 15 ft.	
Accessory to all other uses	Max. 70 ft.	

(d) *Landscaping.*

- (1) *Setbacks.* Required setbacks shall be landscaped. Landscaping shall conform to the standards set forth in SRC chapter 807.
- (2) *Vehicle use areas.* Vehicle use areas shall be landscaped as provided under SRC chapters 806 and 807.
- (3) *Development site.* A minimum of 15 percent of the development site shall be landscaped. Landscaping shall meet the Type A standard set forth in SRC chapter 807. Other required landscaping under the UDC, such as landscaping required for setbacks or vehicular use areas, may count towards meeting this requirement.

(e) *Development standards for continued uses.*

- (1) *Buildings.* Buildings housing a continued use may be structurally altered or enlarged, or rebuilt following damage or destruction, provided such alteration, enlargement, or rebuilding conforms to development standards of the Single Family Residential (RS) Zone set forth in SRC chapter 511, and to all other applicable provisions of the UDC, except the lot size and dimensions standards in SRC chapter 511.
- (2) *Accessory structures.* Existing accessory structures to a continued use may be structurally altered or enlarged, or rebuilt following damage or destruction, and new accessory structures to a continued use may be constructed, provided such

alteration, enlargement, rebuilding, or new accessory structure construction conforms to the development standards of the Single Family Residential (RS) Zone set forth in SRC chapter 511, except the lot size and dimensions standards, and to all other applicable provisions of the UDC.

- (3) *Option to rebuild in same location.* Notwithstanding subsections (e)(1) and (2) of this section, any building or accessory structure rebuilt following damage or destruction may either be located on the same location on the lot as the original building or structure, or in compliance with the setbacks of the Single Family Residential (RS) Zone set forth in SRC 511.010(b).

Sec. 523.015. - Design review.

Design review under SRC chapter 225 is required for development within the CG as follows:

- (a) Multiple family development shall be subject to design review according to the ~~multiple family design review guidelines~~ or the multiple family design review standards set forth in SRC chapter 702.
- (b) Residential care with ~~five~~three or more self-contained dwelling units shall be subject to design review according to the ~~multiple family design review guidelines~~ or the multiple family design review standards set forth in SRC chapter 702.

Sec. 524.005. - Uses.

- (a) Except as otherwise provided in this section, the permitted (P), special (S), conditional (C), and prohibited (N) uses in the CB zone are set forth in Table 524-1.

TABLE 524-1. USES		
Use	Status	Limitations & Qualifications
Household Living		
Single family	P	The following single family activities: <ul style="list-style-type: none"> ■ Single family detached dwelling. ■ Residential home, as defined under ORS 197.660.
	N	All other single family.
Two family	P	Duplex.
	N	All other two family.
<u>Three family</u>	P	
<u>Four family</u>	P	
Multiple family	P	
Group Living		
Room and board	P	Room and board serving 5 or fewer persons.
	C	The following room and board activities: <ul style="list-style-type: none"> ■ Room and board serving 6 to 75 persons.

		<ul style="list-style-type: none"> ■ Relocation of an existing room and board facility within the CB zone serving more than 75 persons, provided the facility has existed within the CB zone as of September 1, 1993, and there is no increase in bed capacity.
	N	All other room and board.
Residential care	P	
Nursing care	P	
Lodging		
Short-term commercial lodging	P	
Long-term commercial lodging	N	
Nonprofit shelters	P	Nonprofit shelters serving 5 or fewer persons.
	C	<p>The following nonprofit shelters:</p> <ul style="list-style-type: none"> ■ Nonprofit shelters serving 6 to 75 persons. ■ Relocation of an existing nonprofit shelter within the CB zone serving more than 75 persons, provided the shelter has existed within the CB zone as of September 1, 1993, and there is no increase in bed capacity.
	P	Nonprofit shelters serving victims of domestic violence for 10 or fewer persons.
	N	All other nonprofit shelters.
Retail Sales and Services		
Eating and drinking establishments	P	
Retail sales	N	Medical marijuana and recreational marijuana sales or transfers, except for retail sales of cannabidiol (CBD) products.
	P	All other retail sales.
Personal services	P	
Postal services and retail financial services	P	
Business and Professional Services		
Office	P	
Audio/visual media production	P	

Laboratory research and testing	P	
Motor Vehicle, Trailer, and Manufactured Dwelling Sales and Service		
Motor vehicle and manufactured dwelling and trailer sales	N	Mobile home dealers.
	P	All other motor vehicle and manufactured dwelling and trailer sales.
Motor vehicle services	P	
Commercial parking	P	
Park-and-ride facilities	P	
Taxicabs and car services	P	
Heavy vehicle and trailer sales	N	
Heavy vehicle and trailer service and storage	N	
Recreation, Entertainment, and Cultural Services and Facilities		
Commercial entertainment—indoor	P	
Commercial entertainment—outdoor	N	Drive-in movie theaters.
	P	All other commercial entertainment—outdoor.
Major event entertainment	P	Major event entertainment conducted indoors.
	N	All other major event entertainment.
Recreational and cultural community services	P	
Parks and open space	P	
Nonprofit membership assembly	P	
Religious assembly	P	
Health Services		
Medical centers/hospitals	N	
Outpatient medical services and laboratories	P	
Educational Services		

Day care	P	
Basic education	P	
Post-secondary and adult education	P	
Civic Services		
Governmental services	P	
Social services	P	
Governmental maintenance services and construction	N	
Public Safety		
Emergency services	P	
Detention facilities	N	
Military installations	P	
Funeral and Related Services		
Cemeteries	N	
Funeral and cremation services	N	
Construction Contracting, Repair, Maintenance, and Industrial Services		
General repair services	P	
Building and grounds services and construction contracting	N	The following building and grounds services and construction contracting activities: <ul style="list-style-type: none"> ■ Building construction. ■ Heavy construction. ■ Disinfecting and pest control services. ■ Building cleaning and maintenance services.
	P	All other building and grounds services and construction contracting.
Cleaning plants	P	
Industrial services	P	
Wholesale Sales, Storage, and Distribution		
General wholesaling	P	General wholesaling is permitted, provided that it is combined with retail sales in the same line of goods.
Heavy wholesaling	P	Nursery stock, provided that it is combined with retail sales in the same line of goods.

	C	The following heavy wholesaling activities, provided they are combined with retail sales in the same line of goods: <ul style="list-style-type: none"> ■ Minerals and ore. ■ Metal service centers and wholesalers. ■ Firearms. ■ Wood products and timber.
	N	All other heavy wholesaling.
Warehousing and distribution	P	Distribution centers for online, mail order, and catalog sales.
	N	All other warehousing and distribution.
Self-service storage	N	
Manufacturing		
General manufacturing	P	General manufacturing, provided the manufacturing does not exceed 10,000 square feet of total floor area per development site and retail sales of the products manufactured is provided on-site.
	C	The following general manufacturing activities, when exceeding 10,000 square feet of total floor area per development site: <ul style="list-style-type: none"> ■ Industrial and institutional food service contractors. ■ Costume jewelry and precious metals metalsmithing. ■ Sundries and notions. ■ Signs.
	N	All other general manufacturing.
Heavy manufacturing	N	
Printing	P	
Transportation Facilities		
Aviation facilities	C	Helicopter landing areas, with or without passenger terminal facilities.
	N	All other aviation facilities.
Passenger ground transportation facilities	P	
Marine facilities	P	
Utilities		
Basic utilities	C	Reservoirs; water storage facilities.
	P	Basic utilities are permitted, unless noted below.

Wireless communication facilities	Allowed	Wireless communication facilities are allowed, subject to SRC chapter 703.
Drinking water treatment facilities	C	
Power generation facilities	C	
Data center facilities	N	
Fuel dealers	N	
Waste-related facilities	C	The following waste-related facilities: <ul style="list-style-type: none"> ■ Recycling depots. ■ Solid waste transfer stations.
	N	All other waste-related facilities.
Mining and Natural Resource Extraction		
Petroleum and natural gas production	N	
Surface mining	N	
Farming, Forestry, and Animal Services		
Agriculture	N	Marijuana production.
	P	All other agriculture.
Forestry	N	
Agriculture and forestry services	P	
Keeping of livestock and other animals	N	
Animal services	N	
Other Uses		
Home occupations	S	Home occupations, subject to SRC 700.020.
Accessory dwelling units	S	Accessory dwelling units, subject to SRC 700.007

(b) Drive-through uses in Salem Downtown Historic District.

- (1) Notwithstanding Table 524-1, banks and credit unions constructed on or after October 1, 2011, within the Salem Downtown Historic District shall be conditional uses within the Salem Downtown Historic District if developed with a drive-through, and adequate measures are taken to ensure pedestrian safety.

- (2) Notwithstanding Table 524-1, any permitted, special, or conditional use within the Salem Downtown Historic District, except for banks and credit unions constructed on or after October 1, 2011, shall be a prohibited use within the Downtown Historic District if developed with a drive-through.

Sec. 524.010. - Development standards.

Development within the CB zone must comply with the development standards set forth in this section.

- (a) *Lot standards.* Lots within the CB zone shall conform to the standards set forth in Table 524-2.

TABLE 524-2. LOT STANDARDS		
Requirement	Standard	Limitations and Qualifications
Lot Area		
All uses	None	
Lot Width		
All uses	None	
Lot Depth		
All uses	None	
Street Frontage		
Single family	Min. 40 ft.	
	Min. 30 ft.	Applicable to lots fronting on the turnaround of a cul-de-sac street or the outside curve of a curved street having a radius of 200 feet or less and a direction change of 60 degrees or more. In no case shall the lot width be less than 40 ft. at the front building setback line.
All other uses	Min. 16 ft.	

- (b) *Setbacks.* Setbacks within the CB zone shall be provided as set forth in Table 524-3.

TABLE 524-3. SETBACKS		
Requirement	Standard	Limitations & Qualifications
Abutting Street		
Buildings		
All uses	0 ft. or 10 ft.	
Accessory Structures		

Accessory to single family, two family, <u>three family, four family,</u> and multiple family	None	Applicable to accessory structures not more than 4 ft. in height.
	0 ft. or 10 ft.	Applicable to accessory structures greater than 4 ft. in height.
Accessory to all other uses	0 ft. or 10 ft.	Not applicable to transit stop shelters.
Vehicle Use Areas		
All uses	Per SRC chapter 806	
Interior Front		
Buildings		
All uses	None	
Accessory Structures		
Accessory to all uses	None	
Vehicle Use Areas		
All uses	Per SRC chapter 806	
Interior Side		
Buildings		
All uses	None	
Accessory Structures		
Accessory to all uses	None	
Vehicle Use Areas		
All uses	Per SRC chapter 806	
Interior Rear		
Buildings		
All uses	None	
Accessory Structures		
Accessory to all uses	None	
Vehicle Use Areas		
All uses	Per SRC chapter 806	

- (c) *Lot coverage; height.* Buildings and accessory structures within the CB zone shall conform to the lot coverage and height standards set forth in Table 524-4.

TABLE 524-4. LOT COVERAGE; HEIGHT		
Requirement	Standard	Limitations & Qualifications
Lot Coverage		
Buildings and Accessory Structures		
All uses	No Max.	
Rear Yard Coverage		
Buildings		
All uses	N/A	
Accessory Structures		
Accessory to all uses	No Max.	
Height		
Buildings		
All uses	No Max.	
Accessory Structures		
Accessory to single family, two family, <u>three family, four family,</u> and multiple family	Max. 15 ft.	
Accessory to all other uses	No Max.	

- (d) *Landscaping.* Landscaping within the CB zone shall be provided as set forth in this subsection.
- (1) *Setbacks.* Required setbacks shall be landscaped. Landscaping shall conform to the standards set forth in SRC chapter 807.
 - (2) *Vehicle use areas.* Vehicle use areas shall be landscaped as provided under SRC chapters 806 and 807.

Sec. 525.005. - Uses.

- (a) Except as otherwise provided in this section, the permitted (P), special (S), conditional (C), and prohibited (N) uses in the WSCB zone are set forth in Table 525-1.

**TABLE 525-1
USES**

Table 525-1: Uses

Use	Status	Limitations and Qualifications
Household living		
Single family	P	The following single family activities: <ul style="list-style-type: none"> ■ Townhouse. ■ Residential home, as defined under ORS 197.660.
	N	All other single family.
Two family	P	
<u>Three family</u>	<u>P</u>	
<u>Four family</u>	<u>P</u>	
Multiple family	P	
Group Living		
Room and board	P	Room and board serving 5 or fewer persons.
	C	Room and board serving 6 to 75 persons.
	N	All other room and board.
Residential care	P	
Nursing care	P	
Lodging		
Short-term commercial lodging	P	
Long-term commercial lodging	P	
Non-profit shelters	P	The following non-profit shelter activities: <ul style="list-style-type: none"> ■ Non-profit shelters serving 5 or fewer persons. ■ Non-profit shelters for victims of domestic violence serving 10 or fewer persons.
	C	Non-profit shelters serving 6 to 75 persons.
	N	All other non-profit shelters.
Retail Sales and Services		
Eating and drinking establishments	P	
Retail sales	P	
Personal services	P	
Postal services and retail financial services	P	

Business and Professional Services		
Office	P	
Audio/visual media production	P	
Laboratory research and testing	P	
Motor Vehicle, Trailer, and Manufactured Dwelling Sales and Service		
Motor vehicle and manufactured dwelling and trailer sales	N	
Motor vehicle services	N	
Commercial parking	P	
Park-and-ride facilities	P	
Taxicabs and car services	N	
Heavy vehicle and trailer sales	N	
Heavy vehicle and trailer service and storage	N	
Recreation, Entertainment, and Cultural Services and Facilities		
Commercial entertainment—indoor	P	
Commercial entertainment—outdoor	P	The following commercial entertainment—outdoor activities: ■ Outdoor swimming pools
	N	All other commercial entertainment—outdoor
Major event entertainment	N	
Recreational and cultural community services	P	
Parks and open space	P	
Non-profit membership assembly	P	
Religious assembly	P	
Health Services		

Medical centers/hospitals	N	
Outpatient medical services and laboratories	P	
Educational Services		
Day care	P	
Basic education	P	
Post-secondary and adult education	P	
Civic Services		
Governmental services	P	
Social services	P	
Governmental maintenance services and construction	N	
Public Safety		
Emergency services	P	
Detention facilities	N	
Military installations	N	
Funeral and Related Services		
Cemeteries	N	
Funeral and cremation services	P	
Construction Contracting, Repair, Maintenance, and Industrial Services		
General repair services	N	
Building and grounds services and construction contracting	N	
Cleaning plants	N	
Industrial services	N	
Wholesale Sales, Storage, and Distribution		
General wholesaling	N	
Heavy wholesaling	N	
Warehousing and distribution	N	

Self-service storage	N	
Manufacturing		
General manufacturing	P	General manufacturing, provided the manufacturing does not exceed 10,000 square feet of total floor area per development site and retail sales of the products manufactured is provided on-site.
	N	All other general manufacturing.
Heavy manufacturing	N	
Printing	P	
Transportation Facilities		
Aviation facilities	C	Helicopter landing areas, with or without passenger terminal facilities.
	N	All other aviation facilities.
Passenger ground transportation facilities	P	
Marine facilities	P	
Utilities		
Basic utilities	C	Reservoirs; water storage facilities.
	P	All other basic utilities.
Wireless communication facilities	Allowed	Wireless communication facilities are allowed, subject to SRC chapter 703.
Drinking water treatment facilities	C	
Power generation facilities	C	
Data center facilities	N	
Fuel dealers	N	
Waste-related facilities	C	The following waste-related facilities: <ul style="list-style-type: none"> ■ Recycling depots. ■ Solid waste transfer stations.
	N	All other waste-related facilities.
Mining and Natural Resource Extraction		
Petroleum and natural gas production	N	
Surface mining	N	

Farming, Forestry, and Animal Services		
Agriculture	N	Marijuana production
	P	All other agriculture
Forestry	P	
Agriculture and forestry services	P	
Keeping of livestock and other animals	N	
Animal services	N	Wildlife rehabilitation facility
	P	
Other Uses		
Home occupations	S	Home occupations, subject to SRC 700.020.

- (b) Prohibited uses. Notwithstanding Table 525-1, any permitted, special, or conditional use within the WSCB District shall be a prohibited use if developed with a drive-through.
- (c) Continued uses. Land uses existing within the WSCB zone prior to June 13, 2018, which would otherwise be made non-conforming by this chapter, are hereby deemed continued uses.
- (1) Buildings or structures housing a continued use may be structurally altered, enlarged, or rebuilt following damage or destruction, provided:
 - (A) Such alteration, enlargement, or rebuilding of a conforming development complies with the standards in this chapter; or
 - (B) Such alteration, enlargement, or rebuilding of a continued development complies with the standards set forth in SRC 525.010(a).
 - (2) Conversion of the building or structure to a conforming use shall thereafter prevent conversion back to the former continued use or any other continued use.
 - (3) A determination by the Building Official that the building or structure housing a continued use is derelict or dangerous, as defined in SRC 50.600 and 56.230, shall terminate the continued use status conferred by this subsection and the property may thereafter only be used for uses allowed in the WSCB zone.

Sec. 525.010. - Development standards.

Development within the WSCB zone must comply with the development standards set forth in this section.

- (a) *Continued development.* Buildings and structures existing within the WSCB zone on June 13, 2018, which would otherwise be made non-conforming by this chapter, are hereby deemed continued development.
 - (1) *Single family uses.*

- (A) *Buildings.* Continued development housing a continued single family use may be structurally altered or enlarged, or rebuilt following damage or destruction, provided such alteration, enlargement, or rebuilding conforms to development standards of the Single Family Residential (RS) zone set forth in SRC chapter 511 and to all other applicable provisions of the UDC, except for lot size and dimension standards in SRC chapter 511.
 - (B) *Accessory structures.* Existing accessory structures on the same property as a continued single family use may be structurally altered or enlarged, or rebuilt following damage or destruction, and new accessory structures to a continued use may be constructed, provided such alteration, enlargement, rebuilding, or new accessory structure construction conforms to the development standards of the Single Family Residential (RS) zone set forth in SRC chapter 511, except the lot size and dimensions standards, and to all other applicable provisions of the UDC.
 - (C) *Option to rebuild in same location.* Notwithstanding SRC 525.010(a)(1)(A) and (B), any continued development housing a continued single family use or associated accessory structure rebuilt following damage or destruction may either be located on the same location on the lot as the original building or structure, or in compliance with the setbacks of the Single Family Residential (RS) zone set forth in SRC 511.010(b).
- (2) *All other uses.* Continued development housing a use other than a continued single family use may be structurally altered, enlarged, or rebuilt following damage or destruction, provided such alteration, enlargement, or rebuilding conforms to the following standards:
- (A) *Minor alterations.* Exterior alterations to buildings that alter an existing building façade area facing a public street right-of-way by less than 20 percent are exempt from all of the development standards in this chapter. Such alterations shall not increase the building façade's nonconformity to the design standards of SRC 525.020.
 - (B) *Minor additions.* Additions to buildings that alter or enlarge an existing building façade area facing a public street right-of-way by less than 20 percent are exempt from all of the development standards in this chapter except for street frontage, interior setbacks, parking, landscaping, and maximum height standards. Such additions shall not increase the building façade's nonconformity to the design standards of SRC 525.020.
 - (C) *Major alterations.* Exterior alterations to buildings that alter an existing building façade area facing a public street right-of-way by between 20 percent and 60 percent shall decrease that building façade's nonconformity to all design standards of SRC 525.020. Such alterations are exempt from all other development standards in this chapter.
 - (D) *Major additions.* Additions to buildings that enlarge an existing building façade area facing a public street right-of-way by between 20 percent and 60 percent shall comply with at least two of the four design review standards of SRC 525.020 and all applicable development standards in this chapter except for

setback abutting a street and the parking location standards of SRC 525.010(g)(1).

- (E) *Substantial alterations.* Exterior alterations to buildings that alter an existing building façade area facing a public street right-of-way by more than 60 percent shall meet all applicable design review guidelines or standards of this chapter. Such alterations are exempt from all other development standards in this chapter.
- (F) *Substantial additions or redevelopment.* Additions to buildings that enlarge an existing building façade area facing a public street right-of-way by more than 60 percent shall meet all applicable development standards and design review guidelines or standards in this chapter. Continued development that is rebuilt following damage or destruction shall meet all applicable development standards and design review guidelines or standards in this chapter.
- (b) *Grade separated street frontage.* Portions of property street frontage that are separated from the grade of the street with a road ramp above the grade of the property line abutting the street are exempt from setbacks abutting a street, off-street parking location, and design review requirements.
- (c) *Lot standards.* Lots within the WSCB zone shall conform to the standards set forth in Table 525-2.

**TABLE 525-2
LOT STANDARDS**

Table 525-2: Lot Standards		
Requirement	Standard	Limitations and Qualifications
LOT AREA		
All uses	None	
LOT WIDTH		
All uses	None	
LOT DEPTH		
All uses	None	
STREET FRONTAGE		
All other uses	Min. 16 ft.	

- (d) *Setbacks.* Setbacks within the WSCB zone shall be provided as set forth in Table 525-3.

**TABLE 525-3
SETBACKS**

Table 525-3: Setbacks

Requirement	Standard	Limitations and Qualifications
ABUTTING STREET		
Buildings		
All uses	0 ft.	Maximum setback of up to 10 feet is permitted if the space is used for pedestrian amenities.
		This setback shall not apply from Wallace Road or side street frontages within 60 feet of Wallace Road.
	Min. 0 ft./Max. 60 ft.	This setback shall apply from Wallace Road NW.
		Where a minimum of 50 percent of the buildable width of a lot is already occupied by buildings, or portions of buildings, located within 60 feet of the Wallace Road right-of-way, the maximum setback shall not apply.
Accessory Structures		
Accessory to single family, two family, <u>three family</u> , <u>four family</u> , and multiple family	None	Applicable to accessory structures not more than 4 ft. in height.
	0 ft. or 10 ft.	Applicable to accessory structures greater than 4 ft. in height.
Accessory to all other uses	0 ft. or 10 ft.	Not applicable to transit stop shelters.
Vehicle Use Areas		
All uses	Per SRC Chapter 806	
INTERIOR FRONT		
Buildings		
All uses	Zone-to-zone setback (Table 525-4)	
Accessory Structures		
Accessory to all uses	Zone-to-zone setback	

	(Table 525-4)	
Vehicle Use Areas		
All uses	Per SRC Chapter 806	
INTERIOR SIDE		
Buildings		
All uses	Zone-to-zone setback (Table 525-4)	
Accessory Structures		
Accessory to all uses	Zone-to-zone setback (Table 525-4)	
Vehicle Use Areas		
All uses	Zone-to-zone setback (Table 525-4)	
INTERIOR REAR		
Buildings		
All uses	Zone-to-zone setback (Table 525-4)	
Accessory Structures		
Accessory to all uses	Zone-to-zone setback (Table 525-4)	
Vehicle Use Areas		

All uses	Zone-to-zone setback (Table 525-4)	
----------	------------------------------------	--

**TABLE 525-4
ZONE-TO-ZONE SETBACKS**

Table 525-4: Zone-to-Zone Setbacks			
Abutting Zone	Type of Improvement	Setback (1)	Landscaping and Screening
EFU	Buildings and accessory structures	Min. 5 ft.	Type A
	Vehicle use areas		
Residential Zone	Buildings and accessory structures	Min. 10 ft.	Type B
	Vehicle use areas		
Mixed-Use Zone	Buildings and accessory structures	None	NA
	Vehicle use areas	Min. 5 ft.	Type A
Commercial Zone	Buildings and accessory structures	None	NA
	Vehicle use areas	Min. 5 ft.	Type A
Public Zone	Buildings and accessory Structures	None	NA
	Vehicle use areas	Min. 5 ft.	Type A
Industrial and Employment Zone: EC, IC, IBC, and IP	Buildings and accessory structures	None	
	Vehicle use areas	Min. 5 ft.	Type A
Industrial and Employment Zone: IG and II	Buildings and accessory structures	Min 10 ft.	Type C
	Vehicle use areas		
Limitations and Qualifications			
(1) Zone-to-Zone setbacks are not required abutting an alley.			

- (e) *Lot coverage; height.* Buildings and accessory structures within the WSCB zone shall conform to the lot coverage and height standards set forth in Table 525-5.

**TABLE 525-5
LOT COVERAGE; HEIGHT**

Table 525-5: Lot Coverage; Height		
Requirement	Standard	Limitations and Qualifications
LOT COVERAGE		
Buildings and Accessory Structures		
All uses	No max.	
REAR YARD COVERAGE		
Buildings		
All uses	No max.	
Accessory Structures		
Accessory to all uses	No Max.	
HEIGHT		
Buildings		
All uses	Max. 70 ft.	
Accessory Structures		
Accessory to single family, two family, <u>three family,</u> <u>four family,</u> and multiple family	Max. 15 ft.	
Accessory to all other uses	Max. 70 ft.	

- (f) *Landscaping.* Landscaping within the WSCB zone shall be provided as set forth in this subsection.
- (1) *Setbacks.* Required setbacks shall be landscaped. Landscaping shall conform to the standards set forth in SRC Chapter 807.
 - (2) *Vehicle use areas.* Vehicle use areas shall be landscaped as provided under SRC chapter 806 and SRC chapter 807.
- (g) *Pedestrian access.* All development, other than development of single family and two family_uses, shall comply with the following pedestrian access standards:

- (1) A pedestrian connection shall be provided from the public sidewalk to the primary building entrance.
 - (2) A pedestrian connection through the parking area to the primary building entrance shall be provided when that parking area contains more than 12 parking spaces.
 - (3) On development sites with multiple buildings, pedestrian connections shall be provided to connect the buildings. Pedestrian connections shall be the most practical, direct route.
 - (4) Pedestrian connections shall be paved, a minimum of five feet in width, and defined by visual contrast or tactile finish texture.
 - (5) Wheel stops or extended curbs shall be provided along required pedestrian connections to prevent the encroachment of vehicles onto pedestrian connections.
- (h) *Off-street parking.*
- (1) Within a single development site, off-street surface parking areas and vehicle maneuvering areas shall be located behind or beside buildings and structures. Off-street surface parking areas and vehicle maneuvering areas shall not be located between a building or structure and a street.
 - (2) Within the WSCB zone, the minimum number of off-street parking spaces required for dwelling units in a multiple family development shall be one per dwelling unit.

Sec. 530.040. - Uses.

- (a) Except as otherwise provided in this section, the permitted (P), special (S), conditional (C), and prohibited (N) uses in the FMU zone are set forth in Table 530-1.

TABLE 530-1. USES					
Use	Status				Limitations & Qualifications
	L	MI	AU	VC	
Household Living					
Single family	P	P	P	P	The following single family activities: <ul style="list-style-type: none"> ■ Single family detached dwelling. ■ Residential home, as defined under ORS 197.660.
	N	P	P	P	Townhouse.
	N	P	P	P	Dwelling unit for a caretaker on the premises being cared for or guarded.
	S	S	S	S	Manufactured home, subject to SRC 700.025.
	N	N	N	N	All other single family.
Two family	N	P	P	P	
<u>Three family</u>	<u>N</u>	<u>P</u>	<u>P</u>	<u>P</u>	
<u>Four family</u>	<u>N</u>	<u>P</u>	<u>P</u>	<u>P</u>	

Multiple family	N	P	P	P	
Group Living					
Room and board	N	P	P	P	Room and board serving 5 or fewer persons.
	N	N	N	N	All other room and board.
Residential care	N	P	P	P	Residential facility, as defined under ORS 197.660.
	N	N	P	P	All other residential care.
Nursing care	N	P	P	P	
Lodging					
Short-term commercial lodging	N	P	P	P	Short-term rentals.
	N	N	P	P	All other short-term commercial lodging.
Long-term commercial lodging	N	P	P	P	
Nonprofit shelters	N	N	N	N	
Retail Sales and Service					
Eating and drinking establishments	N	P	P	P	
Retail sales	N	P	P	P	
Personal services	N	P	P	P	
Postal services and retail financial services	N	P	P	P	
Business and Professional Services					
Office	N	P	P	P	
Audio/visual media production	N	P	P	P	
Laboratory research and testing	N	P	P	P	
Motor Vehicle, Trailer, and Manufactured Dwelling Sales and Services					
Motor vehicle and manufactured dwelling and trailer sales	N	N	N	N	Manufactured dwelling and prefabricated structure sales.
	N	N	P	P	Motor vehicle, recreational vehicle, and trailer rental.
	N	N	C	C	All other motor vehicle and manufactured dwelling and trailer sales.
Motor vehicle services	N	N	P	P	

Commercial parking	N	N	P	P	
Park-and-ride facilities	N	N	P	P	
Taxicabs and car services	N	N	P	P	
Heavy vehicle and trailer sales	N	N	C	N	
Heavy vehicle and trailer service and storage	N	N	P	N	
Recreation, Entertainment, and Cultural Services and Facilities					
Commercial entertainment—indoor	N	C	C	C	Nightclubs, located within 200 feet of a residential zone.
	N	P	P	P	All other commercial entertainment—indoor.
Commercial entertainment—outdoor	N	P	P	P	
Major event entertainment	N	N	N	N	
Recreational and cultural community services	N	P	P	P	
Parks and open space	P	P	P	P	
Nonprofit membership assembly	N	P	P	P	
Religious assembly	N	P	P	P	
Health Services					
Medical centers/hospitals	N	N	N	N	
Outpatient medical services and laboratories	N	P	P	P	
Educational Services					
Day care	N	P	P	P	The following day care activities: ■ Child day care home. ■ Adult day care home.
	N	N	P	P	All other day care.
Basic education	N	P	P	P	
Post-secondary and adult education	N	N	P	P	
Civic Services					

Governmental services	N	P	P	P	
Social services	N	N	P	P	
Governmental maintenance services and construction	N	N	N	N	
Public Safety					
Emergency services	N	N	P	P	The following emergency services activities: ■ Ambulance station. ■ Ambulance service facility.
	N	P	P	P	All other emergency services.
Detention facilities	N	N	N	N	
Military installations	N	P	P	P	
Funeral and Related Services					
Cemeteries	N	P	P	P	
Funeral and cremation services	N	N	P	P	
Construction Contracting, Repair, Maintenance, and Industrial Services					
General repair services	N	N	P	P	
Building and grounds services and construction contracting	N	N	P	N	
Cleaning plants	N	P	P	P	
Industrial services	N	N	P	N	
Wholesale Sales, Storage, and Distribution					
General wholesaling	N	N	P	N	
Heavy wholesaling	N	N	N	N	
Warehousing and distribution	N	N	P	P	
Self-service storage	N	N	P	P	
Manufacturing					
General manufacturing	N	C	P	C	
Heavy manufacturing	N	N	N	N	
Printing	N	C	P	C	
Transportation Facilities					

Aviation facilities	N	N	N	N	
Passenger ground transportation facilities	P	P	P	P	Transit stop shelters.
	N	N	P	P	All other passenger ground transportation facilities.
Marine facilities	N	N	N	N	
Utilities					
Basic utilities	P	P	P	P	
Wireless communication facilities	Allowed				Wireless communication facilities are allowed, subject to SRC chapter 703.
Drinking water treatment facilities	N	N	N	N	
Power generation facilities	N	N	N	N	
Data center facilities	N	N	P	N	
Fuel dealers	N	N	P	N	
Waste-related facilities	N	P	P	P	Recycling depot.
	N	N	N	N	All other waste-related facilities.
Mining and Natural Resource Extraction					
Petroleum and natural gas production	N	N	N	N	
Surface mining	N	N	N	N	
Farming, Forestry, and Animal Services					
Agriculture	N	N	N	N	Marijuana production.
	P	P	P	P	All other agriculture.
Forestry	N	P	P	N	
Agriculture and forestry services	N	N	P	N	
Keeping of livestock and other animals	N	N	N	N	
Animal services	N	P	P	P	Small animal veterinary services.
	N	N	N	N	All other animal services.
Other Uses					

Accessory short-term rentals	S	-	-	-	Accessory short-term rental, subject to SRC 700.006
Temporary uses	N	P	P	P	Residential sales/development office, subject to SRC 701.030.
Home occupations	S	S	S	S	Home occupations, subject to SRC 700.020.
Accessory dwelling units	P	P	P	P	
Taking of boarders or leasing of rooms by a resident family	P	P	P	P	Taking of boarders or leasing of rooms by a resident family is permitted as an accessory use to household living, provided the total number of boarders and roomers does not exceed 2 in any dwelling unit.

- (b) *Additional prohibited uses.* Notwithstanding Table 530-1, eating and drinking establishments otherwise permitted within the FMU zone shall be a prohibited use within the FMU zone if developed with a drive-through.

Sec. 530.050. - Development standards for uses and activities falling under household living.

When uses and activities falling under household living are proposed within a refinement plan, such uses and activities shall be subject to either the development standards set forth in this section or the development standards established in the refinement plan. If development standards for uses and activities falling under household living are established in a refinement plan, approval of such standards shall be reviewed and approved as "alternative approval criteria" under ORS 197.307. Such standards shall apply in lieu of the standards set forth in this section and shall govern all development of uses and activities falling under household living within the refinement plan area. Subsequent to the approval of the refinement plan, if the applicant wishes to pursue development under the standards and criteria set forth in this section, the applicant shall apply for a minor amendment to the refinement plan.

- (a) *Lot standards.* Lots within the FMU zone used for uses and activities falling under household living shall conform to the standards set forth in Table 530-2.

TABLE 530-2. LOT STANDARDS FOR USES AND ACTIVITIES FALLING UNDER HOUSEHOLD LIVING		
Requirement	Standard	Limitations & Qualifications
Lot Area		
All household living uses and activities	None	
Lot Width		
All household living uses and activities	None	

Lot Depth		
All household living uses and activities	None	
Street Frontage		
Single family	Min. 18 ft.	
	Max. 100 ft.	
Two family	Min. 36 ft.	
	Max. 100 ft.	
<u>Three family, four family, and multiple family</u>	Min. 24 ft.	Applicable to multiple family consisting of not more than 4 dwelling units.
	Min. 6 ft. per dwelling unit	Applicable to multiple family consisting of more than 4 dwelling units.
	Max. 30 ft. per dwelling unit	

(b) *Dwelling unit density.* Dwelling unit density within the FMU zone for uses and activities falling under household living shall conform to the standards set forth in Table 530-3.

TABLE 530-3. DWELLING UNIT DENSITY FOR USES AND ACTIVITIES FALLING UNDER HOUSEHOLD LIVING		
Overlay Area	Minimum	Maximum
Limited Intensity (LI)	5 d.u./acre	8 d.u./acre
Mixed Intensity (MI)	7 d.u./acre	35 d.u./acre
Adaptive Use (AU)	6 d.u./acre	30 d.u./acre
Village Center (VC)	16 d.u./acre	35 d.u./acre

(c) *Setbacks.* Setbacks within the FMU zone for uses and activities falling under Household Living shall be provided as set forth in Table 530-4.

TABLE 530-4. SETBACKS FOR USES AND ACTIVITIES FALLING UNDER HOUSEHOLD LIVING		
Requirement	Standard	Limitations & Qualifications
Abutting Street		
Buildings		

All household living uses and activities	Min. 10 ft.	Applicable in the MI, AU, and VC areas.
	Max. 20 ft.	
Accessory Structures		
Accessory to all household living uses and activities	Min. 10 ft.	
Abutting Alley		
Buildings		
All household living uses and activities	Min. 5 ft.	
Accessory Structures		
Accessory to all household living uses and activities	Min. 5 ft.	
Interior Front		
Buildings		
All household living uses and activities	None	
Accessory Structures		
Accessory to all household living uses and activities	None	
Interior Side		
Buildings		
All household living uses and activities	None	
Accessory Structures		
Accessory to all household living uses and activities	None	
Interior Rear		
Buildings		
All household living uses and activities	None	
Accessory Structures		
Accessory to all household living uses and activities	None	

(d) *Lot coverage; height.* Buildings and accessory structures within the FMU zone used for uses and activities falling under household living shall conform to the lot coverage and height standards set forth in Table 530-5.

TABLE 530-5. LOT COVERAGE; HEIGHT FOR USES AND ACTIVITIES FALLING UNDER HOUSEHOLD LIVING

Requirement	Standard	Limitations & Qualifications
Lot Coverage		
Buildings and Accessory Structures		
All household living uses and activities	No Max.	Applicable within the MI, AU, and VC areas.
	Max. 55%	Applicable within the LI area.
Rear Yard Coverage		
Buildings		
All household living uses and activities	N/A	
Accessory Structures		
Accessory to all household living uses and activities	No Max.	
Height		
Buildings		
All household living uses and activities	Max. 35 ft.	Applicable within the LI area.
	Max. 45 ft.	Applicable within the MI, AU, and VC areas.
Accessory Structures		
Accessory to all household living uses and activities	Max 35 ft.	Applicable within the LI area.
	Max. 45 ft.	Applicable within the MI, AU, and VC areas.

(e) *Building orientation.*

- (1) All single family attached dwellings and multiple family residential complexes shall have their primary orientation to the street. Entrances to multiple family buildings may include entrances to individual units or breezeway/courtyard entrances (i.e., to a cluster of residential units); or
- (2) All single family attached dwellings and multiple family residential complexes may have their primary orientation to a side yard when a direct pedestrian connection is provided between the main entrance and the street, with at least one entrance located not more than 20 feet from the curblines of the street.

(f) *Design review guidelines and design review standards.* If multiple family residential design guidelines, design standards, and/or a design review process are not identified in the fairview plan or refinement plan, all multiple family residential development shall

comply with either all of the applicable multiple family design review guidelines or all of the applicable multiple family design review standards set forth in SRC chapter 702.

- (g) *Parking.* The requirements of SRC chapter 806 shall apply to all residential development within the FMU zone, except that:
 - (1) Minimum required off-street parking for single family uses or activities shall be one space per dwelling unit.
 - (2) On-street parking may be used to fulfill a portion of the parking requirement for multifamily residential dwelling units.
- (h) *Landscaping.*
 - (1) Setbacks. Required setbacks shall be landscaped. Landscaping shall conform to the standards set forth in SRC chapter 807.
 - (2) Vehicle use areas. Vehicle use areas shall be landscaped as provided under SRC chapters 806 and 807.
- (i) *Natural resource protection and hazard mitigation.* In order to preserve existing natural resources and prevent natural hazards, the requirements of the following chapters shall apply to residential development within the FMU zone:
 - (1) SRC chapter 808 (Preservation of Trees and Vegetation).
 - (2) SRC chapter 809 (Wetlands).
 - (3) SRC chapter 810 (Landslide Hazards).

Sec. 531.010. - Uses.

- (a) *General.* The permitted (P), special (S), conditional (C), and prohibited (N) uses in the SWMU zone are set forth in Table 531-1.

TABLE 531-1. USES		
Use	Status	Limitations & Qualifications
Household Living		
Single family	P	The following single family activities: <ul style="list-style-type: none"> ■ Townhouse. ■ Residential home, as defined under ORS 197.660.
	N	All other single family.
Two family	P	Duplex.
	N	All other two family.
<u>Three family</u>	<u>P</u>	
<u>Four family</u>	<u>P</u>	
Multiple family	P	

Group Living		
Room and board	N	
Residential care	P	The following residential care activities: <ul style="list-style-type: none"> ■ Residential facility, as defined under ORS 197.660. ■ Assisted living.
	N	All other residential care.
Nursing care	P	In-patient rehabilitation and recuperative care.
	N	All other nursing care.
Lodging		
Short-term commercial lodging	P	
Long-term commercial lodging	N	
Nonprofit shelters	P	Nonprofit shelters serving 5 or fewer persons.
	C	Nonprofit shelters serving 6 to 75 persons.
	N	All other nonprofit shelters.
Retail Sales and Services		
Eating and drinking establishments	P	Eating and drinking establishments, subject to SRC 531.010(c).
Retail sales	P	Retail sales, subject to SRC 531.010(c).
Personal services	P	Personal services, subject to SRC 531.010(c).
Postal services and retail financial services	P	Postal services and retail financial services, subject to SRC 531.010(c).
Business and Professional Services		
Office	P	
Audio/visual media production	P	
Laboratory research and testing	P	Laboratory research and testing, subject to SRC 531.010(c).
Motor Vehicle, Trailer, and Manufactured Dwelling Sales and Service		
Motor vehicle and manufactured dwelling and trailer sales	P	Indoor sales and leasing, subject to SRC 531.010(c).
	N	All other motor vehicle and manufactured dwelling and trailer sales.

Motor vehicle services	N	
Commercial parking	N	Commercial parking on surface parking lots.
	P	All other commercial parking, subject to SRC 531.010(c).
Park-and-ride facilities	P	
Taxicabs and car services	N	
Heavy vehicle and trailer sales	N	
Heavy vehicle and trailer service and storage	N	
Recreation, Entertainment, and Cultural Services and Facilities		
Commercial entertainment—indoor	N	Firing ranges.
	P	All other commercial entertainment—indoor is permitted.
Commercial entertainment—outdoor	N	The following commercial entertainment—outdoor activities: <ul style="list-style-type: none"> ■ Recreational vehicle parks. ■ Firing ranges.
	P	All other commercial entertainment—outdoor.
Major event entertainment	N	
Recreational and cultural community services	P	
Parks and open space	P	
Nonprofit membership assembly	P	
Religious assembly	P	
Health Services		
Medical centers/hospitals	N	
Outpatient medical services and laboratories	P	
Educational Services		
Day care	P	
Basic education	P	
Post-secondary and adult education	P	

Civic Services		
Governmental services	P	
Social services	P	
Governmental maintenance services and construction	N	
Public Safety		
Emergency services	P	
Detention facilities	N	
Military installations	N	
Funeral and Related Services		
Cemeteries	N	
Funeral and cremation services	N	
Construction Contracting, Repair, Maintenance, and Industrial Services		
General repair services	P	General repair services, subject to SRC 531.010(c).
Building and grounds services and construction contracting	N	The following building and grounds services and construction contracting activities: <ul style="list-style-type: none"> ■ Lawn and garden services. ■ Exterminators.
	P	All other building and grounds services and construction contracting, subject to SRC 531.010(c).
Cleaning plants	P	Cleaning plants, subject to SRC 531.010(c).
Industrial services	N	
Wholesale Sales, Storage, and Distribution		
General wholesaling	N	
Heavy wholesaling	N	
Warehousing and distribution	N	
Self-service storage	N	
Manufacturing		
General manufacturing	P	General manufacturing, subject to SRC 531.010(c).
Heavy manufacturing	N	
Printing	P	Printing, subject to SRC 531.010(c).

Transportation Facilities		
Aviation facilities	N	
Passenger ground transportation facilities	P	
Marine facilities	P	
Utilities		
Basic utilities	P	
Wireless communication facilities	Allowed	Wireless communication facilities are allowed, subject to SRC chapter 703.
Drinking water treatment facilities	N	
Power generation facilities	N	
Data center facilities	N	
Fuel dealers	N	
Waste-related facilities	N	
Mining and Natural Resource Extraction		
Petroleum and natural gas production	N	
Surface mining	N	
Farming, Forestry, and Animal Services		
Agriculture	N	
Forestry	N	
Agriculture and forestry services	N	
Keeping of livestock and other animals	N	
Animal services	P	
Other Uses		
Home occupations	S	Home occupations, subject to SRC 700.020.

- (b) *Additional prohibited uses.* Notwithstanding Table 531-1, any permitted, special, or conditional use within the SWMU zone less than 10,000 square feet in total floor shall be a prohibited use within the SWMU zone if developed with a drive-through.
- (c) *Limitations on uses.* Where a use is allowed subject to the provisions of this subsection, the use shall conform to the following additional limitations:

- (1) Establishments under the following uses shall be limited to no more than 10,000 square feet of total floor area per establishment:
 - (A) Laboratory research and testing.
 - (B) Building and grounds services and construction contracting.
 - (C) Cleaning plants.
 - (D) General manufacturing.
 - (E) Printing.
 - (2) The total floor area of all establishments falling under motor vehicle and manufactured dwelling and trailer sales shall be limited to a maximum of 20,000 square feet.
 - (3) Buildings for establishments under the following uses shall be limited to no more than 40,000 square feet of ground floor area:
 - (A) Retail sales, with the exception of grocery stores. Grocery stores shall be limited to buildings with no more than 60,000 square feet of ground floor area.
 - (B) Personal services.
 - (C) Postal services and retail financial services.
 - (D) General repair services.
 - (E) Animal services.
 - (4) Buildings for establishments under the following uses shall be limited to no more than 60,000 square feet of ground floor area:
 - (A) Eating and drinking establishments.
 - (B) Commercial entertainment—indoor.
 - (C) Commercial entertainment—outdoor.
 - (5) Commercial Parking shall be limited to the following locations:
 - (A) Structures existing as of January 7, 2009, that have been rehabilitated or remodeled to allow for the use of the structure for parking.
 - (B) Underground parking structures.
 - (C) Any other structures, provided:
 - (i) No more than 25 percent of the parking spaces within an individual structure shall be used for commercial parking.
 - (ii) The total number of parking spaces within the structures shall not exceed the maximum number of parking spaces allowed for each use pursuant to SRC chapter 806.
- (d) *Mix of uses required.*
- (1) Within the SWMU zone a minimum of 15 percent of each development site shall be household living and a minimum of 15 percent of each development site shall be other than household living. The percentage shall be calculated by determining the percentage of total habitable building floor area devoted to household living activities and the total

habitable building floor area devoted to activities other than household living, relative to the total habitable building floor area, exclusive of parking structures and other non-habitable space. Total habitable building floor area used for short-term commercial lodging may be substituted for up to 25 percent of the required household living area.

- (2) The required mix of uses may be reduced to a minimum of five percent provided the following are met:
- (A) There is a vertical mix of uses in one or more mixed-use buildings. The mix shall include space for activities other than household living on at least a portion of the ground floor and household living activities on one or more upper floors; and
 - (B) All ground floor household living activities facing a public street shall maintain a minimum structural ceiling height of 12 feet to provide the opportunity for future conversion to activities other than household living.

Sec. 532.015. - Uses allowed with neighborhood center master plan.

The permitted (P), special (S), conditional (C), and prohibited (N) uses in the NCMU zone with a neighborhood center master plan are set forth in Table 532-1. The uses set forth in Table 532-1 are only allowed in the NCMU zone as a part of a neighborhood center master plan, approved in accordance with SRC chapter 215, and are allowed based on whether the location of the building or structure housing the use is located inside or outside of the Core Area designated in the master plan.

TABLE 532-1. NCMU ZONE USES WITH MASTER PLAN			
Use	Status		Limitations & Qualifications
	Inside Core	Outside Core	
Household Living			
Single family	N	P	The following single family activities: <ul style="list-style-type: none"> ■ Single family detached dwelling. ■ Townhouse. ■ Residential home, as defined under ORS 197.660.
	N	S	Manufactured home, subject to SRC 700.025.
	N	N	All other single family.
Two family	N	P	Duplex.
	N	N	All other two family.
<u>Three family</u>	<u>P</u>	<u>N</u>	<u>Three family, located in a mixed-use building above ground floor nonresidential uses.</u>
	<u>N</u>	<u>N</u>	<u>All other three family.</u>

Four family	P	N	Three family, located in a mixed-use building above ground floor nonresidential uses.
	N	N	All other four family.
Multiple family	P	N	Multiple family, located in a mixed-use building above ground floor nonresidential uses.
	N	N	All other multiple family.
Group Living			
Room and board	N	N	
Residential care	P	N	Residential care, located in a mixed-use building above ground floor nonresidential uses.
	P	C	Assisted living.
	N	N	All other residential care.
Nursing care	N	N	
Lodging			
Short-term commercial lodging	P	N	Short-term commercial lodging with 5 or fewer guest rooms.
	N	N	All other short-term commercial lodging.
Long-term commercial lodging	N	N	
Nonprofit shelters	N	N	
Retail Sales and Services			
Eating and drinking establishments	P	N	
Retail sales	P	N	
Personal services	P	N	
Postal services and retail financial services	P	N	Retail financial services.
	P	C	Postal services.
Business and Professional Services			
Office	P	N	
Audio/visual media production	N	N	

Laboratory research and testing	N	N	
Motor Vehicle, Trailer, and Manufactured Dwelling Sales and Service			
Motor vehicle and manufactured dwelling and trailer sales	P	N	Indoor sales and leasing.
	N	N	All other motor vehicle and manufactured dwelling and trailer sales.
Motor vehicle services	N	N	
Commercial parking	N	N	
Park-and-ride facilities	N	N	
Taxicabs and car services	N	N	
Heavy vehicle and trailer sales	N	N	
Heavy vehicle and trailer service and storage	N	N	
Recreation, Entertainment, and Cultural Services and Facilities			
Commercial entertainment—indoor	N	N	The following commercial entertainment—indoor activities: <ul style="list-style-type: none"> ■ Firing ranges. ■ Theaters greater than 5,000 square feet. ■ Pool halls. ■ Continuous entertainment activities, such as bowling alleys, ice rinks, and game arcades.
	P	N	All other commercial entertainment - indoor.
Commercial entertainment—outdoor	N	N	
Major event entertainment	N	N	
Recreational and cultural community services	P	C	
Parks and open space	P	P	
Nonprofit membership assembly	P	N	
Religious assembly	P	C	
Health Services			

Medical centers/hospitals	N	N	
Outpatient medical services and laboratories	P	N	
Educational Services			
Day care	P	C	
Basic education	P	C	
Post-secondary and adult education	P	C	
Civic Services			
Governmental services	P	C	
Social services	P	N	
Governmental maintenance services and construction	N	N	
Public Safety			
Emergency services	P	C	
Detention facilities	N	N	
Military installations	N	N	
Funeral and Related Services			
Cemeteries	N	N	
Funeral and cremation services	N	N	
Construction Contracting, Repair, Maintenance, and Industrial Services			
General repair services	P	N	
Building and grounds services and construction contracting	N	N	
Cleaning plants	N	N	
Industrial services	N	N	
Wholesale Sales, Storage, and Distribution			
General wholesaling	N	N	
Heavy wholesaling	N	N	
Warehousing and distribution	N	N	
Self-service storage	N	N	

Manufacturing			
General manufacturing	N	N	
Heavy manufacturing	N	N	
Printing	N	N	
Transportation Facilities			
Aviation facilities	N	N	
Passenger ground transportation facilities	P	P	Transit stop shelters.
	N	N	All other passenger ground transportation facilities.
Marine facilities	N	N	
Utilities			
Basic utilities	C	C	The following basic utilities: <ul style="list-style-type: none"> ■ Pump stations. ■ Reservoirs. ■ Radio microwave relay stations. ■ Telephone substations. ■ Electric substations.
	P	P	All other basic utilities.
Wireless communication facilities	Allowed	Allowed	Wireless communication facilities are allowed, subject to SRC chapter 703.
Drinking water treatment facilities	N	N	
Power generation facilities	N	N	
Data center facilities	N	N	
Fuel dealers	N	N	
Waste-related facilities	N	N	
Mining and Natural Resource Extraction			
Petroleum and natural gas production	N	N	
Surface mining	N	N	
Farming, Forestry, and Animal Services			
Agriculture	N	N	
Forestry	N	N	

Agriculture and forestry services	N	N	
Keeping of livestock and other animals	N	N	
Animal services	N	N	Kennels.
	P	N	All other animal services.
Other Uses			
Home occupations	S	S	Home occupations, subject to SRC 700.020.
Accessory dwelling unit	N	S	Accessory dwelling units, subject to SRC 700.007.

Sec. 532.020. - Uses allowed in-lieu of neighborhood center master plan.

The permitted (P), special (S), conditional (C), and prohibited (N) uses in the NCMU zone in-lieu of a neighborhood center master plan are set forth in Table 532-2. The uses set forth in Table 532-2 are allowed in the NCMU zone in-lieu of development pursuant to a neighborhood center master plan, and are subject to the development standards set forth in SRC 532.035.

TABLE 532-2. NCMU ZONE USES IN-LIEU OF MASTER PLAN

Use	Status	Limitations & Qualifications
Household Living		
Single family	P	The following single family activities: <ul style="list-style-type: none"> ■ Single family detached dwelling. ■ Residential home, as defined under ORS 197.660.
	S	Manufactured home, subject to SRC 700.025.
	N	All other single family.
Two family	N	
<u>Three family</u>	<u>N</u>	
<u>Four family</u>	<u>N</u>	
Multiple family	N	
Group Living		
Room and board	N	
Residential care	N	
Nursing care	N	

Lodging		
Short-term commercial lodging	N	
Long-term commercial lodging	N	
Nonprofit shelters	N	
Retail Sales and Services		
Eating and drinking establishments	N	
Retail sales	N	
Personal services	N	
Postal services and retail financial services	N	
Business and Professional Services		
Office	N	
Audio/visual media production	N	
Laboratory research and testing	N	
Motor Vehicle, Trailer, and Manufactured Dwelling Sales and Service		
Motor vehicle and manufactured dwelling and trailer sales	N	
Motor vehicle services	N	
Commercial parking	N	
Park-and-ride facilities	N	
Taxicabs and car services	N	
Heavy vehicle and trailer sales	N	
Heavy vehicle and trailer service and storage	N	
Recreation, Entertainment, and Cultural Services and Facilities		
Commercial entertainment—indoor	N	
Commercial entertainment—outdoor	N	
Major event entertainment	N	
Recreational and cultural community services	N	
Parks and open space	P	
Nonprofit membership assembly	N	

Religious assembly	N	
Health Services		
Medical centers/hospitals	N	
Outpatient medical services and laboratories	N	
Educational Services		
Day care	N	
Basic education	N	
Post-secondary and adult education	N	
Civic Services		
Governmental services	N	
Social services	N	
Governmental maintenance services and construction	N	
Public Safety		
Emergency services	N	
Detention facilities	N	
Military installations	N	
Funeral and Related Services		
Cemeteries	N	
Funeral and cremation services	N	
Construction Contracting, Repair, Maintenance, and Industrial Services		
General repair services	N	
Building and grounds services and construction contracting	N	
Cleaning plants	N	
Industrial services	N	
Wholesale Sales, Storage, and Distribution		
General wholesaling	N	
Heavy wholesaling	N	
Warehousing and distribution	N	
Self-service storage	N	

Manufacturing		
General manufacturing	N	
Heavy manufacturing	N	
Printing	N	
Transportation Facilities		
Aviation facilities	N	
Passenger ground transportation facilities	N	
Marine facilities	N	
Utilities		
Basic utilities	C	The following basic utilities: <ul style="list-style-type: none"> ■ Pump stations. ■ Reservoirs. ■ Radio microwave relay stations. ■ Telephone substations. ■ Electric substations.
	P	All other basic utilities.
Wireless communication facilities	Allowed	Wireless communication facilities are allowed, subject to SRC chapter 703.
Drinking water treatment facilities	N	
Power generation facilities	N	
Data center facilities	N	
Fuel dealers	N	
Waste-related facilities	N	
Mining and Natural Resource Extraction		
Petroleum and natural gas production	N	
Surface mining	N	
Farming, Forestry, and Animal Services		
Agriculture	N	
Forestry	N	
Agriculture and forestry services	N	
Keeping of livestock and other animals	N	

Animal services	N	
Other Uses		
Home occupations	S	Home occupations, subject to SRC 700.020.
Accessory dwelling unit	S	Accessory dwelling units, subject to SRC 700.007.

Sec. 533.010. - Uses.

(a) The permitted (P), special (S), conditional (C), and prohibited (N) uses in the MU-I zone are set forth in Table 533-1.

**TABLE 533-1
USES**

Table 533-1: Uses		
	Status	
Household Living		
Single family	P	The following single family activities: <ul style="list-style-type: none"> • Townhouse. • Residential home, as defined under ORS 197.660.
	N	All other single family.
Two family	N	
<u>Three family</u>	<u>P</u>	
<u>Four family</u>	<u>P</u>	
Multiple family	P	
Group Living		
Room and board	N	
Residential care	P	The following residential care activities: <ul style="list-style-type: none"> • Residential facility, as defined under ORS 197.660. • Assisted living.
	N	All other residential care.
Nursing care	N	
Lodging		
Short-term commercial lodging	P	

Long-term commercial lodging	N	
Non-profit shelters	P	Non-profit shelters serving 5 or fewer persons.
	C	Non-profit shelters serving 6 to 75 persons.
	N	All other non-profit shelters.
Retail Sales and Services		
Eating and drinking establishments	P	
Retail sales	P	
Personal services	P	
Postal services and retail financial services	P	
Business and Professional Services		
Office	P	
Audio/visual media production	P	
Laboratory research and testing	P	
Motor Vehicle, Trailer, and Manufactured Dwelling Sales and Service		
Motor vehicle and manufactured dwelling and trailer sales	N	
Motor vehicle services	N	
Commercial parking	N	Standalone surface parking lots
	P	All other commercial parking
Park-and-ride facilities	N	
Taxicabs and car services	N	
Heavy vehicle and trailer sales	N	
Heavy vehicle and trailer service and storage	N	
Recreation, Entertainment, and Cultural Services and Facilities		
Commercial entertainment—Indoor	N	Firing ranges
	P	All other commercial entertainment—Indoor.

Commercial entertainment—Outdoor	N	
Major event entertainment	N	
Recreational and cultural community services	P	
Parks and open space	P	
Non-profit membership assembly	P	
Religious assembly	P	
Health Services		
Medical centers/hospitals	N	
Outpatient medical services and laboratories	P	
Educational Services		
Day care	P	
Basic education	P	
Post-secondary and adult education	P	
Civic Services		
Government services	P	
Social services	P	
Governmental maintenance services and construction	N	
Public Safety		
Emergency services	P	
Detention facilities	N	
Military installations	N	
Funeral and Related Services		
Cemeteries	N	
Funeral and cremation services	N	
Construction Contracting, Repair, Maintenance, and Industrial Services		

General repair services	P	
Building and ground services and construction contracting	N	
Cleaning plants	N	
Industrial services	N	
Wholesale Sales, Storage, and Distribution		
General wholesaling	N	
Heavy wholesaling	N	
Warehousing and distribution	N	
Self-service storage	N	
Manufacturing		
General manufacturing	P	General manufacturing, provided the manufacturing does not exceed 5,000 square feet of total floor area per development site and retail sales of the products manufactured is provided on-site.
	N	All other general manufacturing.
Heavy manufacturing	N	
Printing	N	
Transportation Facilities		
Aviation facilities	N	
Passenger ground transportation facilities	P	Transit stop shelters
	N	All other passenger ground transportation facilities
Marine facilities	N	
Utilities		
Basic utilities	N	Reservoirs; water storage facilities; electric substation.
	P	All other basic utilities.
Wireless communication facilities	Allowed	Wireless communication facilities are allowed, subject to SRC chapter 703.
Drinking water treatment facilities	N	
Power generation facilities	N	
Data center facilities	N	

Fuel dealers	N	
Waste-related facilities	N	
Mining and natural resource extraction	N	
Petroleum and natural gas	N	
Surface mining	N	
Farming, Forestry, and Animal Services		
Agriculture	N	
Forestry	N	
Agriculture and forestry services	N	
Keeping of livestock and other animals	N	
Animal services	P	
Other Uses		
Home occupations	S	Home occupations, subject to SRC 700.020.
Accessory dwelling units	S	Accessory dwelling units, subject to SRC 700.007.

(b) *Prohibited uses.* Notwithstanding Table 533-1, any permitted, special, or conditional use within the MU-I zone shall be a prohibited use if developed with a drive-through.

(c) *Continued uses.* Existing uses within the MU-I zone established prior to September 12, 2018, but which would otherwise be made non-conforming by this chapter, are hereby deemed continued uses.

- (1) Buildings or structures housing a continued use may be structurally altered, enlarged, or rebuilt following damage or destruction, provided:
 - (A) Such alteration, enlargement, or rebuilding of a conforming development complies with the standards in this chapter; or
 - (B) Such alteration, enlargement, or rebuilding of a continued development complies with the standards set forth in SRC 533.015(g).
- (2) A continued use shall terminate if the building or structure ceases to be occupied for that continued use for any reason for a continuous period of one year.
- (3) Conversion of the building or structure to a conforming use shall thereafter prevent conversion back to the former continued use or any other continued use.

Sec. 533.020. - Design review.

Design review under SRC chapter 225 is not required for development within the MU-I zone. Multifamily development within the MU-I zone is not subject to design review according to

the multiple family design review guidelines or the multiple family design review standards set forth in SRC chapter 702.

Sec. 534.010. - Uses.

- (a) The permitted (P), special (S), conditional (C), and prohibited (N) uses in the MU-II zone are set forth in Table 534-1.

**TABLE 534-1
USES**

Table 534-1: Uses		
	Status	
Household Living		
Single family	P	The following single family activities: <ul style="list-style-type: none"> • Townhouse. • Residential home, as defined under ORS 197.660.
	N	All other single family.
Two Family	N	
<u>Three family</u>	<u>P</u>	
<u>Four family</u>	<u>P</u>	
Multiple Family	P	
Group Living		
Room and board	P	Room and board serving 5 or fewer persons.
	C	Room and board serving 6 to 75 persons.
	N	All other room and board
Residential care	P	The following residential care activities: <ul style="list-style-type: none"> • Residential facility, as defined under ORS 197.660. • Assisted living.
	N	All other residential care.
Nursing care	N	
Lodging		
Short-term commercial lodging	P	
Long-term commercial lodging	N	
Non-profit shelters	P	Non-profit shelters serving 5 or fewer persons.

	C	Non-profit shelters serving 6 to 75 persons.
	N	All other non-profit shelters.
Retail Sales and Services		
Eating and drinking establishments	P	
Retail sales	P	
Personal services	P	
Postal services and retail financial services	P	
Business and Professional Services		
Office	P	
Audio/visual media production	P	
Laboratory research and testing	P	
Motor Vehicle, Trailer, and Manufactured Dwelling Sales and Service		
Motor vehicle and manufactured dwelling and trailer sales	N	
Motor vehicle services	N	
Commercial parking	N	Standalone surface parking lots
	P	All other commercial parking
Park-and-ride facilities	N	
Taxicabs and car services	N	
Heavy vehicle and trailer sales	N	
Heavy vehicle and trailer service and storage	N	
Recreation, Entertainment, and Cultural Services and Facilities		
Commercial entertainment—Indoor	N	Firing ranges
	P	All other commercial entertainment—Indoor.
Commercial entertainment—Outdoor	N	

Major event entertainment	N	
Recreational and cultural community services	P	
Parks and open space	P	
Non-profit membership assembly	P	
Religious assembly	P	
Health Services		
Medical centers/hospitals	N	
Outpatient medical services and laboratories	P	
Educational Services		
Day care	P	
Basic education	P	
Post-secondary and adult education	P	
Civic Services		
Government services	P	
Social services	P	
Governmental maintenance services and construction	N	
Public Safety		
Emergency services	P	
Detention facilities	N	
Military installations	N	
Funeral and Related Services		
Cemeteries	N	
Funeral and cremation services	N	
Construction Contracting, Repair, Maintenance, and Industrial Services		
General repair services	P	

Building and ground services and construction contracting	N	
Cleaning plants	N	
Industrial services	N	
Wholesale Sales, Storage, and Distribution		
General wholesaling	N	
Heavy wholesaling	N	
Warehousing and distribution	N	
Self-service storage	N	
Manufacturing		
General manufacturing	P	General manufacturing, provided the manufacturing does not exceed 5,000 square feet of total floor area per development site and retail sales of the products manufactured is provided on-site.
	N	All other general manufacturing.
Heavy manufacturing	N	
Printing	N	
Transportation Facilities		
Aviation facilities	N	
Passenger ground transportation facilities	P	Transit stop shelters
	N	All other passenger ground transportation facilities
Marine facilities	N	
Utilities		
Basic utilities	N	Reservoirs; water storage facilities; electric substation.
	P	All other basic utilities.
Wireless communication facilities	Allowed	Wireless communication facilities are allowed, subject to SRC chapter 703.
Drinking water treatment facilities	N	
Power generation facilities	N	
Data center facilities	N	
Fuel dealers	N	

Waste-related facilities	N	
Mining and natural resource extraction	N	
Petroleum and natural gas	N	
Surface mining	N	
Farming, Forestry, and Animal Services		
Agriculture	N	
Forestry	N	
Agriculture and forestry services	N	
Keeping of livestock and other animals	N	
Animal services	P	
Other Uses		
Home occupations	S	Home occupations, subject to SRC 700.020.
Accessory dwelling units	S	Accessory dwelling units, subject to SRC 700.007.

(b) *Prohibited uses.* Notwithstanding Table 534-1, any permitted, special, or conditional use within the MU-I zone shall be a prohibited use if developed with a drive-through.

(c) *Continued uses.* Existing uses within the MU-II zone established prior to September 12, 2018, but which would otherwise be made non-conforming by this chapter, are hereby deemed continued uses.

- (1) Buildings or structures housing a continued use may be structurally altered, enlarged, or rebuilt following damage or destruction, provided:
 - (A) Such alteration, enlargement, or rebuilding of a conforming development complies with the standards in this chapter; or
 - (B) Such alteration, enlargement, or rebuilding of a continued development complies with the standards set forth in SRC 534.015(g).
- (2) A continued use shall terminate if the building or structure ceases to be occupied for that continued use for any reason for a continuous period of one year.
- (3) Conversion of the building or structure to a conforming use shall thereafter prevent conversion back to the former continued use or any other continued use.

Sec. 534.020. - Design review.

Design review under SRC chapter 225 is not required for development within the MU-II zone. Multifamily development within the MU-II zone is not subject to design review according to the multiple family design review guidelines or the multiple family design review standards set forth in SRC chapter 702.

Sec. 535.005. - Uses.

- (a) Except as otherwise provided in this section, the permitted (P), special (S), conditional (C), and prohibited (N) uses in the ESMU zone are set forth in Table 535-1.

**TABLE 535-1
USES**

Table 535-1: Uses		
Use	Status	Limitations and Qualifications
Household Living		
Single family	P	
Two family	P	
<u>Three family</u>	<u>P</u>	
<u>Four family</u>	<u>P</u>	
Multiple family	P	
Group Living		
Room and board	P	Room and board serving 5 or fewer persons.
	C	Room and board serving 6 to 75 persons.
	N	All other room and board.
Residential care	P	
Nursing care	P	
Lodging		
Short-term commercial lodging	P	
Long-term commercial lodging	P	
Non-profit shelters	P	The following non-profit shelter activities: <ul style="list-style-type: none"> ■ Non-profit shelters serving 5 or fewer persons. ■ Non-profit shelters for victims of domestic violence serving 10 or fewer persons.
	C	Non-profit shelters serving 6 to 75 persons.
	N	All other non-profit shelters. L
Retail Sales and Services		

Eating and drinking establishments	P	
Retail sales	P	
Personal services	P	
Postal services and retail financial services	P	
Business and Professional Services		
Office	P	
Audio/visual media production	P	
Laboratory research and testing	P	
Motor Vehicle, Trailer, and Manufactured Dwelling Sales and Service		
Motor vehicle and manufactured dwelling and trailer sales	N	
Motor vehicle services	N	
Commercial parking	P	
Park-and-ride facilities	P	
Taxicabs and car services	N	
Heavy vehicle and trailer sales	N	
Heavy vehicle and trailer service and storage	N	
Recreation, Entertainment, and Cultural Services and Facilities		
Commercial entertainment—indoor	C	Nightclubs, located within 200 feet of a residential zone.
	P	All other commercial entertainment—indoor.
Commercial entertainment—outdoor	N	Privately owned camps, campgrounds, and recreational vehicle parks.
	C	The following commercial entertainment—outdoor activities: <ul style="list-style-type: none"> ■ Amusement parks. ■ Drive-in movie theaters.
	P	All other commercial entertainment—outdoor.
Major event entertainment	N	

Recreational and cultural community services	P	
Parks and open space	P	
Non-profit membership assembly	P	
Religious assembly	P	
Health Services		
Medical centers/hospitals	N	
Outpatient medical services and laboratories	P	
Educational Services		
Day care	P	
Basic education	P	
Post-secondary and adult education	P	
Civic Services		
Governmental services	P	
Social services	P	
Governmental maintenance services and construction	N	
Public Safety		
Emergency services	P	
Detention facilities	N	
Military installations	N	
Funeral and Related Services		
Cemeteries	N	
Funeral and cremation services	P	
Construction Contracting, Repair, Maintenance, and Industrial Services		
General repair services	N	
Building and grounds services and construction contracting	N	

Cleaning plants	N	
Industrial services	N	
Wholesale Sales, Storage, and Distribution		
General wholesaling	N	
Heavy wholesaling	N	
Warehousing and distribution	N	
Self-service storage	N	
Manufacturing		
General manufacturing	P	General manufacturing, provided the manufacturing does not exceed 10,000 square feet of total floor area per development site and retail sales of the products manufactured is provided on-site.
	N	All other general manufacturing.
Heavy manufacturing	N	
Printing	P	
Transportation Facilities		
Aviation facilities	N	
Passenger ground transportation facilities	P	The following passenger ground transportation facilities: <ul style="list-style-type: none"> ■ Local and suburban passenger transportation. ■ Intercity and rural highway passenger transportation
	N	All other passenger ground transportation facilities.
Marine facilities	N	
Utilities		
Basic utilities	C	Reservoirs; water storage facilities.
	P	All other basic utilities.
Wireless communication facilities	Allowed	Wireless communication facilities are allowed, subject to SRC chapter 703.
Drinking water treatment facilities	C	
Power generation facilities	C	
Data center facilities	N	
Fuel dealers	N	
Waste-related facilities	N	

Mining and natural resource extraction		
Petroleum and natural gas production	N	
Surface mining	N	
Farming, Forestry, and Animal Services		
Agriculture	N	
Forestry	N	
Agriculture and forestry services	P	
Keeping of livestock and other animals	N	
Animal services	N	Wildlife rehabilitation facility
	P	
Other Uses		
Home occupations	S	Home occupations are allowed subject to SRC 700.020; provided however, notwithstanding SRC 700.020(d), onsite sales associated with professional services, artists, and craftspeople is permitted.
Accessory dwelling unit	S	Accessory dwelling units, subject to SRC 700.007.

(b) *Prohibited uses.* Notwithstanding Table 535-1, any permitted, special, or conditional use within the ESMU zone shall be a prohibited use if developed with a drive-through.

(c) *Continued uses.* Land uses existing within the ESMU zone prior to June 13, 2018, which would otherwise be made non-conforming by this chapter, are hereby deemed continued uses.

- (1) Buildings or structures housing a continued use may be structurally altered, enlarged, or rebuilt following damage or destruction, provided:
 - (A) Such alteration, enlargement, or rebuilding of a conforming development complies with the standards in this chapter; or
 - (B) Such alteration, enlargement, or rebuilding of a continued development complies with the standards set forth in SRC 535.010(a).
- (2) Conversion of the building or structure to a conforming use shall thereafter prevent conversion back to the former continued use or any other continued use.
- (3) A determination by the Building Official that the building or structure housing a continued use is derelict or dangerous, as defined in SRC 50.600 and 56.230, shall terminate the continued use status conferred by this subsection and the property may thereafter only be used for uses allowed in the ESMU zone.

Sec. 535.010. - Development standards.

Development within the ESMU zone must comply with the development standards set forth in this section.

- (a) *Continued development.* Buildings and structures existing within the ESMU zone on June 13, 2018, but which would otherwise be made non-conforming development by this chapter, are hereby deemed continued development.
 - (1) *Single family uses.*
 - (A) *Buildings.* Continued development housing a single family use may be structurally altered or enlarged, or rebuilt following damage or destruction, provided such alteration, enlargement, or rebuilding conforms to development standards of the Single Family Residential (RS) zone set forth in SRC chapter 511 and to all other applicable provisions of the UDC, except for lot size and dimension standards in SRC chapter 511.
 - (B) *Accessory structures.* Existing accessory structures on the same property as a single family use may be structurally altered or enlarged, or rebuilt following damage or destruction, and new accessory structures may be constructed, provided such alteration, enlargement, rebuilding, or new accessory structure construction conforms to the development standards of the Single Family Residential (RS) zone set forth in SRC chapter 511, except the lot size and dimensions standards.
 - (C) *Option to rebuild in same location.* Notwithstanding SRC 535.015(a)(1)(A) and (B), any continued development housing a single family use or associated accessory structure rebuilt following damage or destruction may either be located on the same location on the lot as the original building or structure, or in compliance with the setbacks of the Single Family Residential (RS) zone set forth in SRC 511.010(b).
 - (2) *All other uses.* Continued development housing a use other than a single family use may be structurally altered, enlarged, or rebuilt following damage or destruction, provided such alteration, enlargement, or rebuilding conforms to the following standards:
 - (A) *Minor alterations.* Exterior alterations to buildings that alter an existing building façade area facing a public street right-of-way by less than 20 percent are exempt from all of the development standards in this chapter. Such alterations and shall not increase the building façade's nonconformity to the design standards of SRC 535.020.
 - (B) *Minor additions.* Additions to buildings that expand or alter an existing building façade area facing a public street right-of-way by less than 20 percent are exempt from all of the development standards in this chapter except for street frontage, interior setbacks, parking for existing buildings, number of spaces required, landscaping, and maximum height standards. Such additions shall not increase the building façade's nonconformity to the design standards of SRC 535.020.
 - (C) *Major alterations.* Exterior alterations to buildings that alter an existing building façade area facing a public street right-of-way by between 20 percent

and 60 percent shall decrease that building façade's nonconformity to all design standards of SRC 535.020. Such alterations are exempt from all other development standards in this chapter.

- (D) *Major additions.* Additions to buildings that enlarge an existing building façade area facing a public street right-of-way by between 20 percent and 60 percent shall comply with all applicable design review guidelines or standards of SRC 535.020, including the alternative standards for existing buildings if applicable, and all applicable development standards in this chapter except for setback abutting a street, building frontage, and the location of parking standards.
 - (E) *Substantial alterations.* Exterior alterations to buildings that alter an existing building façade area facing a public street right-of-way by more than 60 percent shall meet all applicable design review guidelines or standards of this chapter. Such alterations are exempt from all other development standards in this chapter.
 - (F) *Substantial additions or redevelopment.* Additions to buildings that enlarge an existing building façade area facing a public street right-of-way by more than 60 percent shall meet all applicable development standards and design review guidelines or standards in this chapter. Continued development that is rebuilt following damage or destruction shall meet all applicable development standards and design review guidelines or standards in this chapter.
- (b) *Grade separated street frontage.* Portions of property street frontage that are separated from the grade of the street with a road ramp above the grade of the property line abutting the street are exempt from setbacks abutting a street, building frontage standards, off-street parking location standards, and design review guidelines and standards for building location, orientation, and design.
 - (c) *Lot standards.* Lots within the ESMU zone shall conform to the standards set forth in Table 535-2.

**TABLE 535-2
LOT STANDARDS**

Table 535-2: Lot Standards		
Requirement	Standard	Limitations and Qualifications
LOT AREA		
All uses	None	
LOT WIDTH		
All uses	None	
LOT DEPTH		
All uses	None	
STREET FRONTAGE		

All other uses	Min. 16 ft.	
----------------	-------------	--

(d) *Setbacks.* Setbacks within the ESMU zone shall be provided as set forth in Table 535-3.

**TABLE 535-3
SETBACKS**

Table 535-3: Setbacks		
Requirement	Standard	Limitations and Qualifications
ABUTTING STREET		
Buildings and Accessory Structures		
Single family, two family, three family, four family, and multiple family	None	
All other uses	0 ft.	Setback greater than 0 feet, up to a maximum setback of up to 10 feet, is permitted if the space is used for pedestrian amenities.
		Applicable to single family, two family, and multiple family that is part of a mixed-use development.
		Not applicable to transit stop shelters.
Vehicle Use Areas		
All uses	Per SRC chapter 806	
INTERIOR FRONT		
Buildings		
Single family	None	
All other uses	Zone-to-zone setback (Table 535-4)	
Accessory Structures		
Accessory to single family	None	
Accessory to all other uses	Zone-to-zone setback	

	(Table 535-4)	
Vehicle Use Areas		
All uses	Per SRC chapter 806	
INTERIOR SIDE		
Buildings		
Single family	None	
All other uses	Zone-to-zone setback (Table 535-4)	
Accessory Structures		
Accessory to single family	None	
Accessory to all other uses	Zone-to-zone setback (Table 535-4)	
Vehicle Use Areas		
All uses	Zone-to-zone setback (Table 535-4)	
INTERIOR REAR		
Buildings		
Single family	None	
All other uses	Zone-to-zone setback (Table 535-4)	
Accessory Structures		
Accessory to single family	None	
Accessory to all other uses	Zone-to-zone setback (Table 535-4)	

Vehicle Use Areas		
All uses	Zone-to-zone setback (Table 535-4)	

**TABLE 535-4
ZONE-TO-ZONE SETBACKS**

Table 535-4: Zone-to-Zone Setbacks			
Abutting Zone	Type of Improvement	Setback (1)	Landscaping and Screening
EFU	Buildings and accessory structures	None	NA
	Vehicle use areas	Min. 5 ft.	Type A
Residential Zone	Buildings and accessory structures	Min. 20 ft. (2)	Type C
	Vehicle use areas	Min. 15 ft.	
Mixed-Use Zone	Buildings and accessory structures	None	NA
	Vehicle use areas	Min. 5 ft.	Type A
Commercial Zone	Buildings and accessory structures	None	NA
	Vehicle use areas	Min. 5 ft.	Type A
Public Zone	Buildings and accessory structures	None	NA
	Vehicle use areas	Min. 5 ft.	Type A
Industrial and Employment Zone: EC, IC, IBC, and IP	Buildings and accessory structures	Min. 5 ft.	Type A
	Vehicle use areas		
Industrial and Employment Zone: IG and II	Buildings and accessory structures	Min 10 ft.	Type C
	Vehicle use areas		
Limitations and Qualifications			

(1) Zone-to-zone setbacks are not required abutting an alley.
 (2) Notwithstanding qualification (1) above, zone-to-zone setbacks for buildings and structures are required abutting an alley when the abutting zone across the alley is residential. Vehicle use areas remain under qualification (1), and do not require a zone-to-zone setback abutting an alley when the abutting zone across the alley is residential.

(e) *Lot coverage; height.* Buildings and accessory structures within the ESMU zone shall conform to the lot coverage, height, and building frontage standards set forth in Table 535-5.

**TABLE 535-5
 LOT COVERAGE; HEIGHT**

Table 535-5: Lot Coverage; Height		
Requirement	Standard	Limitations and Qualifications
LOT COVERAGE		
Buildings and Accessory Structures		
All uses	No Max.	
REAR YARD COVERAGE		
Buildings		
All uses	No Max.	
Accessory Structures		
Accessory to all uses	No Max.	
HEIGHT		
Buildings		
All uses	Max. 50 ft.	
Accessory Structures		
Accessory to single family, two family, <u>three family, four family, and multiple family</u>	Max. 15 ft.	
Accessory to all other uses	Max. 50 ft.	
BUILDING FRONTAGE		

All uses	Min. 50%	Applies to development sites along Edgewater Street and Second Street, between Rosemont Avenue and Wallace Road, except that where a development site has frontage on Edgewater Street or Second Street and a side street, the minimum building frontage requirement does not apply to the side street frontage.
----------	----------	--

- (f) *Landscaping.* Landscaping within the ESMU zone shall be provided as set forth in this subsection.
- (1) *Setbacks.* Required setbacks shall be landscaped. Landscaping shall conform to the standards set forth in SRC chapter 807.
 - (2) *Vehicle use areas.* Vehicle use areas shall be landscaped as provided under SRC chapter 806 and SRC chapter 807.
 - (3) *Development site.* A minimum of 15 percent of the development site shall be landscaped. Landscaping shall meet the Type A standard set forth in SRC chapter 807. Other required landscaping under the UDC, such as landscaping required for setbacks or vehicle use areas, may count towards meeting this requirement.
- (g) *Pedestrian access.* All development, other than development of single family and two family uses, shall comply with the following pedestrian access standards:
- (1) A pedestrian connection shall be provided from the public sidewalk to the primary building entrance.
 - (2) A pedestrian connection through the parking area to the primary building entrance shall be provided when that parking area contains more than 12 parking spaces.
 - (3) On development sites with multiple buildings, pedestrian connections shall be provided to connect the buildings. Pedestrian connections shall be the most practical, direct route.
 - (4) Pedestrian connections shall be paved, a minimum of five feet in width, and defined by visual contrast or tactile finish texture.
 - (5) Wheel stops or extended curbs shall be provided along required pedestrian connections to prevent the encroachment of vehicles onto pedestrian connections.
- (h) *Project enhancements.* All development, other than development of single family and two family uses, shall include four or more of the following project enhancements:
- (1) Closure of one driveway approach on Edgewater Street;
 - (2) Joint parking agreement under SRC 806.020(a)(5) or implementation of a plan to satisfy off-street parking requirements through alternative modes of transportation under SRC 806.015(e)(2);
 - (3) Cast iron or wrought iron fencing adjacent to Edgewater Street or Second Street;
 - (4) Pedestrian connections that are:
 - (A) Constructed with pavers, scored or colored cement, and/or stamped asphalt;
 - (B) Elevated above the parking area and driveway; or

- (C) Defined with landscaping or building features such as canopies, awnings, or arcades;
 - (5) Replacement of existing surface parking areas with new development of buildings or structures;
 - (6) Provision of one or more of the following pedestrian-oriented design features on property adjacent to Edgewater Street or Second Street:
 - (A) Pedestrian scale lighting not more than 16 feet in height; or
 - (B) Plazas or other outdoor spaces open to the public;
 - (7) A minimum of seven percent interior landscaping within parking areas not more than 50,000 square feet in size; or a minimum of ten percent interior landscaping within parking areas greater than 50,000 square feet in size;
 - (8) Installation of landscaping and irrigation using a plan designed by an Oregon landscape architect;
 - (9) Development of a mixed-use building;
 - (10) Construction of a building where at least 75 percent of the building frontage is constructed contiguous to the minimum building setback line;
 - (11) Provision of underground, structured, or tuck-under parking. For purposes of this paragraph, "tuck-under parking" means parking placed at grade with a building constructed above it;
 - (12) Construction of one or more buildings at least two stories in height;
 - (13) Construction of planter bays, each a minimum of 50 square feet in size, to meet minimum interior parking area landscaping requirements;
 - (14) Construction of planter bays below the surface grade of parking areas to accommodate surface water runoff; or
 - (15) Use of native plant materials to meet minimum landscaping requirements.
- (i) *Dwelling unit density.* Dwelling unit density within the ESMU zone shall conform to the standards set forth in Table 535-6. Dwelling unit density cannot be varied or adjusted.

Table 535-6: Dwelling Unit Density			
Use	Standard		Limitations and Qualifications
	Minimum	Maximum	
Single family, two family, <u>three family</u> , <u>four family</u> , and multiple family	8 dwelling units per acre	None	
	1 dwelling unit per acre	None	Applicable to Single Family, Two Family, <u>Three Family</u> , <u>Four Family</u> , and Multiple Family within a mixed-use building.

- (j) *Off-street parking.*
 - (1) *Locations of parking.* Off-street surface parking areas and vehicle maneuvering areas shall be located behind or beside buildings and structures. Off-street surface parking areas and vehicle maneuvering areas shall not be located between a building or structure and a street.
 - (2) *Parking for existing buildings.* Except for new single family, two family, three family, four family, or multiple family uses, there is no minimum off-street parking requirement for development sites with buildings in existence as of June 13, 2018, and located between Rosemont Avenue and Wallace Road, provided there is no increase in building square footage and any existing parking is not reduced, except as necessary to comply with state and federal law, including the Americans with Disabilities Act.
 - (3) *Minimum number of spaces required.* Within the ESMU zone, the minimum number of off-street parking spaces required for dwelling units in a multiple family development shall be one per dwelling unit.
- (k) *Screening.* Concertina or barbed wire fencing shall not be located within 60 feet of the street right-of-way, unless such fencing is obstructed by a building or structure.

Sec. 535.015. - Design review.

Design review under SRC chapter 225 is required for development within ESMU zone as follows:

- (a) Except as otherwise provided in this section, design review according to the design review guidelines or the design review standards set forth in SRC 535.020 is required for all development within the ESMU zone.
- (b) Design review according to the design review guidelines or the design review standards set forth in SRC 535.020 is not required for:
 - (1) Development of single family uses.
 - (2) Development of two family uses.
- (c) Multiple family development, other than multiple family development within a mixed-use building, shall only be subject to design review according to the ~~multiple family design review guidelines or the multiple family design review standards~~ set forth in SRC chapter 702.
- (d) Multiple family development within a mixed-use building shall only be subject to design review according to the design review guidelines or the design review standards set forth in SRC 535.020.
- (e) Any development requiring historic design review shall only be subject to design review according to the historic design review standards or the historic design review guidelines set forth in SRC chapter 230.

Sec. 540.005. - Uses.

The permitted (P), special (S), conditional (C), and prohibited (N) uses in the PA zone are set forth in Table 540-1.

TABLE 540-1. USES

Use	Status	Limitations & Qualifications
Household Living		
Single family	P	The following single family activities: <ul style="list-style-type: none"> ■ Dwelling unit for a caretaker on the premises being cared for or guarded. ■ Houseboats, when developed in conjunction with a marina.
	S	Manufactured home as a dwelling for a caretaker, subject to SRC 700.030.
	N	All other single family.
Two family	N	
<u>Three family</u>	<u>N</u>	
<u>Four family</u>	<u>N</u>	
Multiple family	N	
Group Living		
Room and board	N	
Residential care	N	
Nursing care	N	
Lodging		
Short-term commercial lodging	N	
Long-term commercial lodging	N	
Nonprofit shelters	N	
Retail Sales and Service		
Eating and drinking establishments	P	Mobile food units.
	N	All other eating and drinking establishments.
Retail sales	N	
Personal services	N	
Postal services and retail financial services	N	
Business and Professional Services		
Office	N	
Audio/visual media production	N	

Laboratory research and testing	N	
Motor Vehicle, Trailer, and Manufactured Dwelling Sales and Services		
Motor vehicle and manufactured dwelling and trailer sales	N	
Motor vehicle services	N	
Commercial parking	N	
Park-and-ride facilities	N	
Taxicabs and car services	N	
Heavy vehicle and trailer sales	N	
Heavy vehicle and trailer service and storage	N	
Recreation, Entertainment, and Cultural Services and Facilities		
Commercial entertainment—indoor	P	
Commercial entertainment—outdoor	N	The following commercial entertainment—outdoor activities: <ul style="list-style-type: none"> ■ Camps. ■ Recreational vehicle parks.
	P	All other commercial entertainment—indoor.
Major event entertainment	P	
Recreational and cultural community services	P	
Parks and open space	P	
Nonprofit membership assembly	N	
Religious assembly	N	
Health Services		
Medical centers/hospitals	N	
Outpatient medical services and laboratories	N	
Educational Services		
Day care	N	
Basic education	N	
Post-secondary and adult education	N	
Civic Services		

Governmental services	N	
Social services	N	
Governmental maintenance services and construction	N	
Public Safety		
Emergency services	P	
Detention facilities	N	
Military installations	P	
Funeral and Related Services		
Cemeteries	N	
Funeral and cremation services	N	
Construction Contracting, Repair, Maintenance, and Industrial Services		
General repair services	N	
Building and grounds services and construction contracting	N	
Cleaning plants	N	
Industrial services	N	
Wholesale Sales, Storage, and Distribution		
General wholesaling	N	
Heavy wholesaling	N	
Warehousing and distribution	N	
Self-service storage	N	
Manufacturing		
General manufacturing	N	
Heavy manufacturing	N	
Printing	N	
Transportation Facilities		
Aviation facilities	N	
Passenger ground transportation facilities	P	Transit stop shelters.
	N	All other passenger ground transportation facilities.

Marine facilities	P	Marinas.
	N	All other marine facilities.
Utilities		
Basic utilities	P	
Wireless communication facilities	Allowed	Wireless communication facilities are allowed, subject to SRC chapter 703.
Drinking water treatment facilities	N	
Power generation facilities	N	
Data center facilities	N	
Fuel dealers	N	
Waste-related facilities	N	
Mining and Natural Resource Extraction		
Petroleum and natural gas production	N	
Surface mining	N	
Farming, Forestry, and Animal Services		
Agriculture	N	Marijuana production.
	P	All other agriculture.
Forestry	P	
Agriculture and forestry services	N	
Keeping of livestock and other animals	N	
Animal services	C	Wildlife rehabilitation facilities.
	N	All other animal services.
Other Uses		
Home occupations	N	

Sec. 541.005. - Uses.

The permitted (P), special (S), conditional (C), and prohibited (N) uses in the PC zone are set forth in Table 541-1.

TABLE 541-1. USES		
Use	Status	Limitations & Qualifications
Household Living		

Single family	P	Dwelling unit for a caretaker on the premises being cared for or guarded.
	S	Manufactured home as a dwelling for a caretaker, subject to SRC 700.030.
	N	All other single family.
Two family	N	
<u>Three family</u>	<u>N</u>	
<u>Four family</u>	<u>N</u>	
Multiple family	N	
Group Living		
Room and board	N	
Residential care	N	
Nursing care	N	
Lodging		
Short-term commercial lodging	N	
Long-term commercial lodging	N	
Nonprofit shelters	N	
Retail Sales and Service		
Eating and drinking establishments	N	
Retail sales	N	
Personal services	N	
Postal services and retail financial services	N	
Business and Professional Services		
Office	N	
Audio/visual media production	N	
Laboratory research and testing	N	
Motor Vehicle, Trailer, and Manufactured Dwelling Sales and Services		
Motor vehicle and manufactured dwelling and trailer sales	N	
Motor vehicle services	N	
Commercial parking	N	

Park-and-ride facilities	N	
Taxicabs and car services	N	
Heavy vehicle and trailer sales	N	
Heavy vehicle and trailer service and storage	N	
Recreation, Entertainment, and Cultural Services and Facilities		
Commercial entertainment—indoor	N	
Commercial entertainment—outdoor	N	
Major event entertainment	N	
Recreational and cultural community services	N	
Parks and open space	P	
Nonprofit membership assembly	N	
Religious assembly	N	
Health Services		
Medical centers/hospitals	N	
Outpatient medical services and laboratories	N	
Educational Services		
Day care	N	
Basic education	N	
Post-secondary and adult education	N	
Civic Services		
Governmental services	N	
Social services	N	
Governmental maintenance services and construction	N	
Public Safety		
Emergency services	N	
Detention facilities	N	
Military installations	N	
Funeral and Related Services		

Cemeteries	P	
Funeral and cremation services	C	
Construction Contracting, Repair, Maintenance, and Industrial Services		
General repair services	N	
Building and grounds services and construction contracting	N	
Cleaning plants	N	
Industrial services	N	
Wholesale Sales, Storage, and Distribution		
General wholesaling	N	
Heavy wholesaling	N	
Warehousing and distribution	N	
Self-service storage	N	
Manufacturing		
General manufacturing	N	
Heavy manufacturing	N	
Printing	N	
Transportation Facilities		
Aviation facilities	N	
Passenger ground transportation facilities	P	Transit stop shelters.
	N	All other passenger ground transportation facilities.
Marine facilities	N	
Utilities		
Basic utilities	P	
Wireless communication facilities	Allowed	Wireless communication facilities are allowed, subject to SRC chapter 703.
Drinking water treatment facilities	N	
Power generation facilities	N	
Data center facilities	N	
Fuel dealers	N	

Waste-related facilities	N	
Mining and Natural Resource Extraction		
Petroleum and natural gas production	N	
Surface mining	N	
Farming, Forestry, and Animal Services		
Agriculture	N	Marijuana production.
	P	All other agriculture.
Forestry	P	
Agriculture and forestry services	N	
Keeping of livestock and other animals	N	
Animal services	N	
Other Uses		
Home occupations	N	

Sec. 542.005. - Uses.

The permitted (P), special (S), conditional (C), and prohibited (N) uses in the PE zone are set forth in Table 542-1.

TABLE 542-1. USES		
Use	Status	Limitations & Qualifications
Household Living		
Single family	P	Dwelling unit for a caretaker on the premises being cared for or guarded.
	S	Manufactured home as a dwelling for a caretaker, subject to SRC 700.030.
	N	All other single family.
Two family	N	
<u>Three family</u>	<u>N</u>	
<u>Four family</u>	<u>N</u>	
Multiple family	N	
Group Living		
Room and board	N	

Residential care	P	
Nursing care	P	
Lodging		
Short-term commercial lodging	N	
Long-term commercial lodging	N	
Nonprofit shelters	P	
Retail Sales and Service		
Eating and drinking establishments	P	Mobile food units.
	N	All other eating and drinking establishments.
Retail sales	N	
Personal services	N	
Postal services and retail financial services	N	
Business and Professional Services		
Office	P	The following office activities: <ul style="list-style-type: none"> ■ Distance education and distance learning. ■ Home health care services.
	N	All other office.
Audio/visual media production	N	
Laboratory research and testing	N	
Motor Vehicle, Trailer, and Manufactured Dwelling Sales and Services		
Motor vehicle and manufactured dwelling and trailer sales	N	
Motor vehicle services	N	
Commercial parking	N	
Park-and-ride facilities	N	
Taxicabs and car services	N	
Heavy vehicle and trailer sales	N	
Heavy vehicle and trailer service and storage	N	
Recreation, Entertainment, and Cultural Services and Facilities		
Commercial entertainment—indoor	N	
Commercial entertainment—outdoor	N	

Major event entertainment	N	
Recreational and cultural community services	P	
Parks and open space	P	
Nonprofit membership assembly	N	
Religious assembly	N	
Health Services		
Medical centers/hospitals	P	
Outpatient medical services and laboratories	P	
Educational Services		
Day care	P	
Basic education	P	
Post-secondary and adult education	P	
Civic Services		
Governmental services	N	
Social services	P	
Governmental maintenance services and construction	N	
Public Safety		
Emergency services	P	
Detention facilities	N	
Military installations	N	
Funeral and Related Services		
Cemeteries	N	
Funeral and cremation services	N	
Construction Contracting, Repair, Maintenance, and Industrial Services		
General repair services	N	
Building and grounds services and construction contracting	N	
Cleaning plants	N	
Industrial services	N	

Wholesale Sales, Storage, and Distribution		
General wholesaling	N	
Heavy wholesaling	N	
Warehousing and distribution	N	
Self-service storage	N	
Manufacturing		
General manufacturing	N	
Heavy manufacturing	N	
Printing	N	
Transportation Facilities		
Aviation facilities	N	
Passenger ground transportation facilities	P	Transit stop shelters.
	N	All other passenger ground transportation facilities.
Marine facilities	N	
Utilities		
Basic utilities	P	
Wireless communication facilities	Allowed	Wireless communication facilities are allowed, subject to SRC chapter 703.
Drinking water treatment facilities	N	
Power generation facilities	N	
Data center facilities	N	
Fuel dealers	N	
Waste-related facilities	N	
Mining and Natural Resource Extraction		
Petroleum and natural gas production	N	
Surface mining	N	
Farming, Forestry, and Animal Services		
Agriculture	N	Marijuana production.
	P	All other agriculture.
Forestry	P	

Agriculture and forestry services	N	
Keeping of livestock and other animals	N	
Animal services	C	Wildlife rehabilitation facilities.
	N	All other animal services.
Other Uses		
Home occupations	N	

Sec. 542.015. - Design review.

Design review under SRC chapter 225 is required for development within the PE as follows:

- (a) Residential care with ~~five~~three or more self-contained dwelling units shall be subject to design review according to ~~the multiple family design review guidelines or the multiple family design review standards set forth in SRC chapter 702.~~

Sec. 543.005. - Uses.

The permitted (P), special (S), conditional (C), and prohibited (N) uses in the PH zone are set forth in Table 543-1.

TABLE 543-1. USES		
Use	Status	Limitations & Qualifications
Household Living		
Single family	P	Dwelling unit for a caretaker on the premises being cared for or guarded.
	S	Manufactured home as a dwelling for a caretaker, subject to SRC 700.030.
	N	All other single family.
Two family	N	
<u>Three family</u>	<u>N</u>	
<u>Four family</u>	<u>N</u>	
Multiple family	P	Conversion or rehabilitation of a historic contributing building or local historic resource for multiple family residential use, when owned and managed by a public agency or a public/private partnership.
	N	All other multiple family.
Group Living		

Room and board	N	
Residential care	P	
Nursing care	P	
Lodging		
Short-term commercial lodging	N	
Long-term commercial lodging	N	
Nonprofit shelters	P	
Retail Sales and Service		
Eating and drinking establishments	P	Mobile food units.
	N	All other eating and drinking establishments.
Retail sales	P	Drug stores and pharmacies.
	N	All other retail sales.
Personal services	N	
Postal services and retail financial services	N	
Business and Professional Services		
Office	P	Home health care services.
	C	Distance education and distance learning.
	N	All other office.
Audio/visual media production	N	
Laboratory research and testing	N	
Motor Vehicle, Trailer, and Manufactured Dwelling Sales and Services		
Motor vehicle and manufactured dwelling and trailer sales	N	
Motor vehicle services	N	
Commercial parking	N	
Park-and-ride facilities	N	
Taxicabs and car services	N	

Heavy vehicle and trailer sales	N	
Heavy vehicle and trailer service and storage	N	
Recreation, Entertainment, and Cultural Services and Facilities		
Commercial entertainment—indoor	N	
Commercial entertainment—outdoor	N	
Major event entertainment	N	
Recreational and cultural community services	P	
Parks and open space	P	
Nonprofit membership assembly	N	
Religious assembly	N	
Health Services		
Medical centers/hospitals	P	
Outpatient medical services and laboratories	P	
Educational Services		
Day care	P	
Basic education	C	
Post-secondary and adult education	C	
Civic Services		
Governmental services	P	Administration of public health programs.
	N	All other governmental services.
Social services	P	
Governmental maintenance services and construction	N	

Public Safety		
Emergency services	P	
Detention facilities	P	
Military installations	N	
Funeral and Related Services		
Cemeteries	N	
Funeral and cremation services	N	
Construction Contracting, Repair, Maintenance, and Industrial Services		
General repair services	N	
Building and grounds services and construction contracting	N	
Cleaning plants	N	
Industrial services	N	
Wholesale Sales, Storage, and Distribution		
General wholesaling	N	
Heavy wholesaling	N	
Warehousing and distribution	P	General warehousing and storage, when operated by a public entity.
	N	All other warehousing and distribution.
Self-service storage	N	
Manufacturing		
General manufacturing	N	
Heavy manufacturing	N	
Printing	N	
Transportation Facilities		
Aviation facilities	P	Helicopter landing areas.
	N	All other aviation facilities.
Passenger ground transportation facilities	P	Transit stop shelters.
	N	All other passenger ground transportation facilities.
Marine facilities	N	

Utilities		
Basic utilities	P	
Wireless communication facilities	Allowed	Wireless communication facilities are allowed, subject to SRC chapter 703.
Drinking water treatment facilities	N	
Power generation facilities	N	
Data center facilities	N	
Fuel dealers	N	
Waste-related facilities	P	Compost facility for yard debris franchise haulers and government entities, when located on the site of, and in compliance with, the Oregon State Corrections Area Plan.
	N	All other waste-related facilities.
Mining and Natural Resource Extraction		
Petroleum and natural gas production	N	
Surface mining	N	
Farming, Forestry, and Animal Services		
Agriculture	N	Marijuana production.
	P	All other agriculture.
Forestry	P	
Agriculture and forestry services	N	
Keeping of livestock and other animals	N	
Animal services	C	Wildlife rehabilitation facilities.
	N	All other animal services.
Other Uses		
Home occupations	N	

Sec. 543.015. - Design review.

Design review under SRC chapter 225 is required for development within the PH as follows:

- (a) Residential care with ~~five~~three or more self-contained dwelling units shall be subject to design review according to ~~the multiple family design review guidelines or the multiple family design review standards set forth in SRC chapter 702.~~

Sec. 544.005. - Uses.

The permitted (P), special (S), conditional (C), and prohibited (N) uses in the PS zone are set forth in Table 544-1.

TABLE 544-1. USES		
Use	Status	Limitations & Qualifications
Household Living		
Single family	P	Dwelling unit for a caretaker on the premises being cared for or guarded.
	S	Manufactured home as a dwelling for a caretaker, subject to SRC 700.030.
	N	All other single family.
Two family	N	
<u>Three family</u>	<u>N</u>	
<u>Four family</u>	<u>N</u>	
Multiple family	N	
Group Living		
Room and board	N	
Residential care	P	
Nursing care	P	
Lodging		
Short-term commercial lodging	N	
Long-term commercial lodging	N	
Nonprofit shelters	P	
Retail Sales and Service		
Eating and drinking establishments	P	
retail sales	P	Caterers.
	N	All other retail sales.
Personal services	N	
Postal services and retail financial services	N	

Business and Professional Services		
Office	P	The following office activities: <ul style="list-style-type: none"> ■ Distance education and distance learning. ■ Home health care services. ■ Information technology services.
	N	All other office.
Audio/visual media production	N	
Laboratory research and testing	N	
Motor Vehicle, Trailer, and Manufactured Dwelling Sales and Services		
Motor vehicle and manufactured dwelling and trailer sales	N	
Motor vehicle services	N	
Commercial parking	N	
Park-and-ride facilities	P	
Taxicabs and car services	N	
Heavy vehicle and trailer sales	N	
Heavy vehicle and trailer service and storage	P	
Recreation, Entertainment, and Cultural Services and Facilities		
Commercial entertainment—indoor	N	
Commercial entertainment—outdoor	N	
Major event entertainment	N	
Recreational and cultural community services	P	
Parks and open space	P	
Nonprofit membership assembly	N	
Religious assembly	N	
Health Services		
Medical centers/hospitals	P	
Outpatient medical services and laboratories	P	
Educational Services		
Day care	P	

Basic education	P	
Post-secondary and adult education	P	
Civic Services		
Governmental services	P	
Social services	P	
Governmental maintenance services and construction	P	
Public Safety		
Emergency services	P	
Detention facilities	P	
Military installations	P	
Funeral and Related Services		
Cemeteries	N	
Funeral and cremation services	N	
Construction Contracting, Repair, Maintenance, and Industrial Services		
General repair services	N	
Building and grounds services and construction contracting	N	
Cleaning plants	N	
Industrial services	N	
Wholesale Sales, Storage, and Distribution		
General wholesaling	N	
Heavy wholesaling	N	
Warehousing and distribution	P	Major post offices and postal distributions centers.
	N	All other warehousing and distribution.
Self-service storage	N	
Manufacturing		
General manufacturing	N	
Heavy manufacturing	N	
Printing	P	
Transportation Facilities		

Aviation facilities	P	Helicopter landing areas.
	N	All other aviation facilities.
Passenger ground transportation facilities	P	
Marine facilities	N	
Utilities		
Basic utilities	P	
Wireless communication facilities	Allowed	Wireless communication facilities are allowed, subject to SRC chapter 703.
Drinking water treatment facilities	P	
Power generation facilities	P	
Data center facilities	P	
Fuel dealers	N	
Waste-related facilities	C	Solid waste disposal sites.
	N	All other waste-related facilities.
Mining and Natural Resource Extraction		
Petroleum and natural gas production	N	
Surface mining	N	
Farming, Forestry, and Animal Services		
Agriculture	N	Marijuana production.
	P	All other agriculture.
Forestry	P	
Agriculture and forestry services	N	
Keeping of livestock and other animals	N	
Animal services	C	Wildlife rehabilitation facility.
	N	All other animal services.
Other Uses		
Home occupations	N	

Sec. 544.015. - Design review.

Design review under SRC chapter 225 is required for development within the PS as follows:

- (a) Residential care with ~~five~~three or more self-contained dwelling units shall be subject to design review according to ~~the multiple family design review guidelines or the multiple family design review standards set forth in SRC chapter 702.~~

Sec. 545.005. - Uses.

The permitted (P), special (S), conditional (C), and prohibited (N) uses in the PM zone are set forth in Table 545-1.

TABLE 545-1. USES		
Use	Status	Limitations & Qualifications
Household Living		
Single family	P	The following single family activities: <ul style="list-style-type: none"> ■ Single family detached dwelling. ■ Dwelling unit for a caretaker on the premises being cared for or guarded.
	N	All other single family.
Two family	P	Duplex Two family, when located on a corner lot.
	N	All other two family.
Three family	<u>S</u>	<u>Subject to SRC 700.081.</u>
Four family	<u>S</u>	<u>Subject to SRC 700.081.</u>
Multiple family	P	
Group Living		
Room and board	P	
Residential care	P	
Nursing care	N	
Lodging		
Short-term commercial lodging	N	
Long-term commercial lodging	N	
Nonprofit shelters	P	
Retail Sales and Service		
Eating and drinking establishments	P	
Retail sales	P	Caterers.
	N	All other retail sales.

Personal services	N	
Postal services and retail financial services	P	
Business and Professional Services		
Office	P	
Audio/visual media production	N	
Laboratory research and testing	P	
Motor Vehicle, Trailer, and Manufactured Dwelling Sales and Services		
Motor vehicle and manufactured dwelling and trailer sales	N	
Motor vehicle services	N	
Commercial parking	P	
Park-and-ride facilities	P	
Taxicabs and car services	N	
Heavy vehicle and trailer sales	N	
Heavy vehicle and trailer service and storage	N	
Recreation, Entertainment, and Cultural Services and Facilities		
Commercial entertainment—indoor	N	
Commercial entertainment—outdoor	N	
Major event entertainment	N	
Recreational and cultural community services	P	
Parks and open space	P	
Nonprofit membership assembly	P	

Religious assembly	P	
Health Services		
Medical centers/hospitals	N	
Outpatient medical services and laboratories	N	The following outpatient medical services and laboratories activities: <ul style="list-style-type: none"> ■ Medical laboratories. ■ Dental laboratories. ■ Outpatient care facilities. ■ Kidney dialysis centers. ■ Commercial blood banks, plasma centers. ■ Commercial reproductive services.
	P	All other outpatient medical services and laboratories.
Educational Services		
Day care	P	
Basic education	N	
Post-secondary and adult education	N	
Civic Services		
Governmental services	P	
Social services	P	
Governmental maintenance services and construction	P	
Public Safety		
Emergency services	N	The following emergency services activities: <ul style="list-style-type: none"> ■ Ambulance station. ■ Ambulance service facility.
	P	All other emergency services.
Detention facilities	P	
Military installations	P	
Funeral and Related Services		
Cemeteries	P	
Funeral and cremation services	N	
Construction Contracting, Repair, Maintenance, and Industrial Services		
General repair services	N	

Building and grounds services and construction contracting	P	The following building and grounds services and construction contracting activities: <ul style="list-style-type: none"> ■ Disinfecting and pest control services. ■ Building cleaning and maintenance services.
	N	All other building and grounds services and construction contracting.
Cleaning plants	N	
Industrial services	N	
Wholesale Sales, Storage, and Distribution		
General wholesaling	N	
Heavy wholesaling	N	
Warehousing and distribution	N	
Self-service storage	N	
Manufacturing		
General manufacturing	N	
Heavy manufacturing	N	
Printing	N	
Transportation Facilities		
Aviation facilities	P	Helicopter landing areas.
	N	All other aviation facilities.
Passenger ground transportation facilities	P	Transit stop shelters.
	N	All other passenger ground transportation facilities.
Marine facilities	N	
Utilities		
Basic utilities	P	
Wireless communication facilities	Allowed	Wireless communication facilities are allowed, subject to SRC chapter 703.
Drinking water treatment facilities	N	
Power generation facilities	N	
Data center facilities	P	
Fuel dealers	N	

Waste-related facilities	N	
Mining and Natural Resource Extraction		
Petroleum and natural gas production	N	
Surface mining	N	
Farming, Forestry, and Animal Services		
Agriculture	N	Marijuana production.
	P	All other agriculture.
Forestry	P	
Agriculture and forestry services	N	
Keeping of livestock and other animals	N	
Animal services	N	
Other Uses		
Accessory short-term rentals	S	Accessory short-term rental, subject to SRC 700.006
Home occupations	S	Home occupations, subject to SRC 700.020.
Guest houses and guest quarters	P	Guest houses and guest quarters are permitted as an accessory use to single family, provided such houses and quarters are dependent upon the main building for either kitchen or bathroom facilities, or both, and are used for temporary lodging and not as a place of residence.
Storage of commercial vehicle as an accessory use to household living	P	Storage of a commercial vehicle as an accessory use to household living is permitted, provided no more than 1 commercial vehicle is stored per dwelling unit.

Sec. 545.010. - Development standards.

Development within the PM zone must comply with the development standards set forth in this section.

- (a) *Lot standards.* Lots within the PM zone shall conform to the standards set forth in Table 545-2.

TABLE 545-2. LOT STANDARDS

Requirement	Standard	Limitations & Qualifications
Lot Area		
Single family	Min. 4,000 sq. ft.	
Two family, <u>three family</u> , and four family	Min. 7,000 sq. ft.	
All other uses	Min. 10,000 sq. ft.	
Lot Width		
Single family, two family, <u>three family</u> , <u>four family</u> , and multiple family	Min. 40 ft.	
All other uses	Min. 50 ft.	
Lot Depth		
All uses	Min. 80 ft.	
Street Frontage		
Single family	Min. 40 ft.	
	Min. 30 ft.	Applicable to lots fronting along the turnaround of a cul-de-sac street or the outside curve of a curved street having a radius of 200 feet or less and a direction change of 60 degrees or more. In no case shall the lot width be less than 40 ft. at the front building setback line.
All other uses	Min. 16 ft.	

- (b) *Dwelling unit density.* Dwelling unit density within the PM zone shall conform to the standards set forth in Table 545-3. Maximum dwelling unit density cannot be varied or adjusted.

TABLE 545-3. DWELLING UNIT DENSITY			
Use	Standard		Limitations & Qualifications
	Minimum	Maximum	
Single family and two family	N/A	N/A	
<u>Three family, four family, and multiple family</u>	None	28 dwelling units per acre	

(c) *Setbacks.* Setbacks within the PM zone shall be provided as set forth in Table 545-4.

TABLE 545-4. SETBACKS		
Requirement	Standard	Limitations & Qualifications
Abutting Street		
Buildings		
All uses	Min. 20 ft.	Applicable to buildings not more than 35 ft. in height.
	Min. 20 ft., plus 1 ft. for each 1 ft. of height over 35 ft., but need not exceed 50 ft. in depth.	Applicable to buildings greater than 35 ft. in height.
Accessory Structures		
Accessory to single family, two family, <u>three family, four family,</u> and multiple family	None	Applicable to accessory structures not more than 4 ft. in height.
	Min. 20 ft.	Applicable to accessory structures greater than 4 ft. in height.
Accessory to all other uses	Min. 20 ft.	Applicable to accessory structures not more than 35 ft. in height.
	Min. 20 ft., plus 1 ft. for each 1 ft. of height over 35 ft., but need not exceed 50 ft. in depth.	Applicable to accessory structures greater than 35 ft. in height.
	None	Applicable to transit stop shelters.
Vehicle Use Areas		
All uses	Per SRC chapter 806	
Interior Front		
Buildings		
All uses	Min. 5 ft.	Applicable to any portion of a building not more than 35 ft. in height.
	Min. 20 ft.	Applicable to any portion of a building greater than 35 ft. in height.
Accessory Structures		
Accessory to single family, and two family,	Min. 5 ft.	

<u>three family, and four family</u>		
Accessory to all other uses	Min. 5 ft.	Applicable to any portion of an accessory structure not more than 35 ft. in height.
	Min. 20 ft.	Applicable to any portion of an accessory structure greater than 35 ft. in height.
Vehicle Use Areas		
All uses	Per SRC chapter 806	
Interior Side		
Buildings		
All uses	Min. 5 ft.	Applicable to any portion of a building not more than 35 ft. in height.
	Min. 20 ft.	Applicable to any portion of a building greater than 35 ft. in height.
Accessory Structures		
Accessory to single family, and two family, <u>three family, and four family</u>	None	Applicable to accessory structures having at least 1 wall which is an integral part of a fence.
	Min. 5 ft.	Applicable to all other accessory structures.
Accessory to all other uses	Min. 5 ft.	Applicable to any portion of an accessory structure not more than 35 ft. in height.
	Min. 20 ft.	Applicable to any portion of an accessory structure greater than 35 ft. in height.
Vehicle Use Areas		
All uses	Per SRC chapter 806	
Interior Rear		
Buildings		
All uses	Min. 5 ft.	Applicable to any portion of a building not more than 35 ft. in height.
	Min. 20 ft.	Applicable to any portion of a building greater than 35 ft. in height.

Accessory Structures		
Accessory to single family, and two family, <u>three family, and four family</u>	None	Applicable to accessory structures not more than 9 ft. in height.
	Min. 1 foot for each 1 ft. of height over 9 feet.	Applicable to accessory structures greater than 9 ft. in height.
	Min. 1 ft.	Applicable to accessory structures adjacent to an alley, unless a greater setback is required based on the height of the accessory structure.
Accessory to all other uses	Min. 5 ft.	Applicable to any portion of an accessory structure not more than 35 ft. in height.
	Min. 20 ft.	Applicable to any portion of an accessory structure greater than 35 ft. in height.
Vehicle Use Areas		
All uses	Per SRC chapter 806	

- (d) *Lot coverage; height.* Buildings and accessory structures within the PM zone shall conform to the lot coverage and height standards set forth in Table 545-5.

TABLE 545-5. LOT COVERAGE; HEIGHT		
Requirement	Standard	Limitations & Qualifications
Lot Coverage		
Buildings and Accessory Structures		
All uses	Max. 60%	
Height		
Buildings		
Single family, two family, <u>three family, four family, and multiple family</u>	Max. 35 ft.	
All other uses	Max. 70 ft.	
Accessory Structures		
Accessory to single family, two family, <u>three family, four family, and multiple family</u>	Max. 15 ft.	

Accessory to all other uses	Max. 70 ft.	
-----------------------------	-------------	--

- (e) *Landscaping.*
 - (1) *Setbacks.* Required setbacks shall be landscaped. Landscaping shall conform to the standards set forth in SRC chapter 807.
 - (2) *Vehicle use areas.* Vehicle use areas shall be landscaped as provided under SRC chapters 806 and 807.
- (f) *Outdoor storage.* Within the PM zone, outdoor storage shall be screened from streets and adjacent properties by a minimum six-foot-high sight-obscuring fence, wall, or hedge.

Sec. 545.015. - Design review.

Design review under SRC chapter 225 is required for development within the PM as follows:

- (a) Multiple family development shall be subject to design review according to ~~the multiple family design review guidelines or the multiple family design review standards~~ set forth in SRC chapter 702.
- (b) Residential care with ~~five~~three or more self-contained dwelling units shall be subject to design review according to ~~the multiple family design review guidelines or the multiple family design review standards~~ set forth in SRC chapter 702.

Sec. 550.010. - Uses.

- (a) *EC zone.* The permitted (P), special (S), conditional (C), and prohibited (N) uses in the EC zone are set forth in Table 550-1.

TABLE 550-1. EC ZONE USES		
Use	Status	Limitations & Qualifications
Household Living		
Single family	P	Dwelling unit for a caretaker or watchperson on the premises being cared for or guarded.
	N	All other single family.
Two family	N	
Three family	<u>N</u>	
Four family	<u>N</u>	
Multiple family	N	
Group Living		
Room and board	N	

Residential care	N	
Nursing care	N	
Lodging		
Short-term commercial lodging	N	
Long- term commercial lodging	N	
Nonprofit shelters	N	
Retail Sales and Service		
Eating and drinking establishments	N	
Retail sales	N	
Personal services	N	
Postal services and retail financial services	N	
Business and Professional Services		
Office	N	Public utility offices.
	P	All other office.
Audio/visual media production	P	
Laboratory research and testing	P	
Motor Vehicle, Trailer, and Manufactured Dwelling Sales and Service		
Motor vehicle and manufactured dwelling and trailer sales	N	
Motor vehicle services	N	
Commercial parking	N	
Park-and-ride facilities	N	
Taxicabs and car services	N	
Heavy vehicle and trailer sales	P	
Heavy vehicle and trailer service and storage	N	
Recreation, Entertainment, and Cultural Services and Facilities		
Commercial entertainment—indoor	N	

Commercial entertainment— outdoor	N	
Major event entertainment	N	
Recreational and cultural community services	N	
Parks and open space	P	
Nonprofit membership assembly	N	
Religious assembly	N	
Health Services		
Medical centers/hospitals	N	
Outpatient medical services and laboratories	P	
Educational Services		
Day care	N	
Basic education	N	
Post-secondary and adult education	N	
Civic Services		
Governmental services	N	
Social services	N	
Governmental maintenance services and construction	N	
Public Safety		
Emergency services	P	
Detention facilities	N	
Military installations	N	
Funeral and Related Services		
Cemeteries	N	
Funeral and cremation services	N	
Construction Contracting, Repair, Maintenance, and Industrial Services		
General repair services	N	
	N	Public utility service and storage yards.

Building and grounds services and construction contracting	P	All other building and grounds services and construction contracting.
Cleaning plants	P	
Industrial services	P	
Wholesale Sales, Storage, and Distribution		
General wholesaling	P	
Heavy wholesaling	N	The following heavy wholesaling activities: <ul style="list-style-type: none"> ■ Salvage or wrecking yards. ■ Scrap dealers.
	P	All other heavy wholesaling.
Warehousing and distribution	N	The following warehousing and distribution activities: <ul style="list-style-type: none"> ■ Stockpiling of sand, gravel, or other aggregate materials. ■ Storage of weapons and ammunition.
	P	All other warehousing and distribution.
Self-service storage	N	
Manufacturing		
General manufacturing	P	
Heavy manufacturing	N	The following heavy manufacturing activities: <ul style="list-style-type: none"> ■ Animal slaughtering and processing. ■ Cement, concrete, and asphalt product manufacturing. ■ Nonmetallic mineral product manufacturing. ■ Lumber mills, pulp and paper mills, and other similar wood products manufacturing.
	P	All other heavy manufacturing.
Printing	P	
Transportation Facilities		
Aviation facilities	N	
Passenger ground transportation facilities	P	Transit stop shelters.
	N	All other passenger ground transportation facilities.
Marine facilities	N	
Utilities		

Basic utilities	P	
Wireless communication facilities	Allowed	Wireless communication facilities are allowed, subject to SRC chapter 703.
Drinking water treatment facilities	N	
Power generation facilities	P	
Data center facilities	P	
Fuel dealers	N	Solid fuel dealers.
	P	All other fuel dealers are permitted.
Waste-related facilities	P	Recycling operations.
	N	All other waste-related facilities.
Mining and Natural Resource Extraction		
Petroleum and natural gas production	N	
Surface mining	N	
Farming, Forestry, and Animal Services		
Agriculture	N	Marijuana production.
	P	All other agriculture.
Forestry	N	
Agriculture and forestry services	P	
Keeping of livestock and other animals	N	
Animal services	N	
Other Uses		
Home occupations	N	

(b) *EC Retail-Service Center Subzone*. The permitted (P), special (S), conditional (C), and prohibited (N) uses in the EC Retail-Service Center Subzone are set forth in Table 550-2. Such uses are the only uses allowed within the EC Retail-Service Center Subzone.

TABLE 550-2. EC RETAIL-SERVICE CENTER SUBZONE USES		
Use	Status	Limitations and Qualifications
Household Living		
Single family	N	
Two family	N	

<u>Three family</u>	<u>N</u>	
<u>Four family</u>	<u>N</u>	
Multiple family	N	
Group Living		
Room and board	N	
Residential care	N	
Nursing care	N	
Lodging		
Short-term commercial lodging	P	
Long- term commercial lodging	N	
Nonprofit shelters	N	
Retail Sales and Service		
Eating and drinking establishments	P	
Retail sales	P	
Personal services	P	
Postal and retail financial services	P	
Business and Professional Services		
Office	P	
	N	
Audio/visual media production	N	
Laboratory research and testing	N	
Motor Vehicle, Trailer, and Manufactured Dwelling Sales and Service		
Motor vehicle and manufactured dwelling and trailer sales	N	
Motor vehicle services	P	The following motor vehicle services: <ul style="list-style-type: none"> ■ Gasoline service stations. ■ Car washes. ■ Quick lubrication services.
	N	All other motor vehicle services.
Commercial parking	N	
Park-and-ride facilities	N	
Taxicabs and car services	N	

Heavy vehicle and trailer sales	N	
Heavy vehicle and trailer service and storage	N	
Recreation, Entertainment, and Cultural Services and Facilities		
Commercial entertainment—indoor	N	Theaters.
	P	All other commercial entertainment—indoor.
Commercial entertainment—outdoor	N	The following commercial entertainment—outdoor activities: <ul style="list-style-type: none"> ■ Recreational vehicle parks. ■ Drive-in movie theaters.
	P	All other commercial entertainment—outdoor.
Major event entertainment	N	
Recreational and cultural community services	N	
Parks and open space	N	
Nonprofit membership assembly	N	
Religious assembly	N	
Health Services		
Medical centers/hospitals	N	
Outpatient medical services and laboratories	P	
Educational Services		
Day care	P	
Basic education	N	
Post-secondary and adult education	P	The following post-secondary and adult education activities: <ul style="list-style-type: none"> ■ Business schools. ■ Vocational schools.
	N	All other post-secondary and adult education.
Civic Services		
Governmental services	N	
Social services	N	

Governmental maintenance services and construction	N	
Public Safety		
Emergency services	N	
Detention facilities	N	
Military installations	N	
Funeral and Related Services		
Cemeteries	N	
Funeral and cremation services	N	
Construction Contracting, Repair, Maintenance, and Industrial Services		
General repair services	P	
Building and grounds services and construction contracting	N	
Cleaning plants	N	
Industrial services	N	
Wholesale Sales, Storage, and Distribution		
General wholesaling	N	
Heavy wholesaling	N	
Warehousing and distribution	N	
Self-service storage	N	
Manufacturing		
General manufacturing	N	
Heavy manufacturing	N	
Printing	N	
Transportation Facilities		
Aviation facilities	N	
Passenger ground transportation facilities	P	Transit stop shelters.
	N	All other passenger ground transportation services.
Marine facilities	N	
Utilities		
Basic utilities	P	

Wireless communication facilities	Allowed	Wireless communication facilities are allowed, subject to SRC chapter 703.
Drinking water treatment facilities	N	
Power generation facilities	N	
Data center facilities	N	
Fuel dealers	N	
Waste-related facilities	P	Recycling depots.
	N	All other waste-related facilities.
Mining and Natural Resource Extraction		
Petroleum and natural gas production	N	
Surface mining	N	
Farming, Forestry, and Animal Services		
Agriculture	N	
Forestry	N	
Agriculture and forestry services	N	
Keeping of livestock and other animals	N	
Animal services	P	
Other Uses		
Home occupations	N	

Sec. 551.005. - Uses.

- (a) Except as otherwise provided in this section, the permitted (P), special (S), conditional (C), and prohibited (N) uses in the IC zone are set forth in Table 551-1.

TABLE 551-1. USES		
Use	Status	Limitations & Qualifications
Household Living		
Single family	P	The following single family activities: <ul style="list-style-type: none"> ■ Residential home, as defined under ORS 197.660, within an existing single family dwelling allowed as a continued use pursuant to SRC 551.005(b). ■ Dwelling unit for a caretaker on the premises being cared for or guarded.
	S	Manufactured home as a dwelling for a caretaker, subject to SRC 700.030.

	C	The following single family activities: <ul style="list-style-type: none"> ■ Single family detached dwelling. ■ Residential home, as defined under ORS 197.660. ■ Manufactured home.
	N	All other single family.
Two family	C	Duplex.
	N	All other two family.
<u>Three family</u>	<u>S</u>	<u>Subject to SRC 700.081.</u>
<u>Four Family</u>	<u>S</u>	<u>Subject to SRC 700.081.</u>
Multiple family	C	
Group Living		
Room and board	C	Room and board serving up to 75 persons.
	N	All other room and board.
Residential care	C	
Nursing care	P	
Lodging		
Short-term commercial lodging	P	
Long- term commercial lodging	C	
Nonprofit shelters	C	Nonprofit shelters serving up to 75 persons.
	P	Nonprofit shelters serving victims of domestic violence for 10 or fewer persons.
	N	All other nonprofit shelters.
Retail Sales and Service		
Eating and drinking establishments	P	
Retail sales	P	
Personal services	P	
Postal services and retail financial services	P	
Business and Professional Services		
Office	P	
Audio/visual media production	P	

Laboratory research and testing	P	
Motor Vehicle, Trailer, and Manufactured Dwelling Sales and Service		
Motor vehicle and manufactured dwelling and trailer sales	P	
Motor vehicle services	P	
Commercial parking	P	
Park-and-ride facilities	P	
Taxicabs and car services	P	
Heavy vehicle and trailer sales	P	
Heavy vehicle and trailer service and storage	P	
Recreation, Entertainment, and Cultural Services and Facilities		
Commercial entertainment—indoor	C	Night clubs, located within 200 feet of a residential zone.
	P	All other commercial entertainment—indoor.
Commercial entertainment—outdoor	P	
Major event entertainment	N	Race tracks.
	P	All other major event entertainment.
Recreational and cultural community services	P	
Parks and open space	P	
Nonprofit membership assembly	P	
Religious assembly	P	
Health Services		
Medical centers/hospitals	N	
Outpatient medical services and laboratories	P	
Education Services		
Day care	P	

Basic education	P	
Post-secondary and adult education	P	
Civic Services		
Governmental services	P	
Social services	P	
Governmental maintenance services and construction	P	
Public Safety		
Emergency services	P	
Detention facilities	N	
Military installations	P	
Funeral and Related Services		
Cemeteries	N	
Funeral and cremation services	P	
Construction Contracting, Repair, Maintenance, and Industrial Services		
General repair services	P	
Building and grounds services and construction contracting	P	
Cleaning plants	P	
Industrial services	P	
Wholesale Sales, Storage, and Distribution		
General wholesaling	P	
Heavy wholesaling	C	The following heavy wholesaling activities: <ul style="list-style-type: none"> ■ Firearms wholesalers. ■ Wood products and timber wholesalers.
	N	The following heavy wholesaling activities: <ul style="list-style-type: none"> ■ Chemicals and allied products wholesalers. ■ Scrap dealers.
	P	All other heavy wholesaling.
Warehousing and distribution	P	
Self-service storage	P	

Manufacturing		
General manufacturing	P	<p>The following general manufacturing activities:</p> <ul style="list-style-type: none"> ■ Industrial and institutional food service contractors. ■ Sign manufacturing. ■ Fabrics, leather goods, footwear, and apparel manufacturing. Except rubber and plastic footwear manufacturing. ■ General food manufacturing. ■ Beverage and related products manufacturing. ■ Tobacco products manufacturing. ■ Cabinetry. ■ Aircraft and aircraft parts manufacturing. ■ Motor vehicles and motor vehicle equipment manufacturing. ■ Computer and electronics manufacturing. ■ Paperboard containers and boxes manufacturing. ■ Rubber and plastic footwear manufacturing. ■ Rubber and plastics products manufacturing. ■ Costume jewelry and precious metals metalsmithing. ■ Furniture manufacturing. ■ Fabricated metal products manufacturing. ■ Wood product manufacturing. ■ Engineered wood product manufacturing. ■ Wood preservation. ■ Plastics and rubber products manufacturing. ■ General chemical manufacturing. ■ Leather tanning. ■ Metal coating and engraving. ■ Battery manufacturing. ■ Ship and boat building. <p>The following general manufacturing activities:</p> <ul style="list-style-type: none"> ■ Commercial and service industry machinery manufacturing. ■ Metalworking machinery manufacturing. ■ Sawmill and woodworking machinery manufacturing.
	N	All other general manufacturing.
Heavy manufacturing	N	
Printing	P	
Transportation Facilities		
Aviation facilities	C	Helicopter landing areas, with or without passenger and freight terminal facilities.
	N	All other aviation facilities.

Passenger ground transportation facilities	P	
Marine facilities	P	
Utilities		
Basic utilities	P	
Wireless communication facilities	Allowed	Wireless communication facilities are allowed, subject to SRC chapter 703.
Drinking water treatment facilities	C	
Power generation facilities	C	
Data center facilities	P	
Fuel dealers	P	
Waste-related facilities	P	Recycling depots.
	C	Solid waste transfer stations.
	N	All other waste-related facilities.
Mining and Natural Resource Extraction		
Petroleum and natural gas production	C	
Surface mining	N	
Farming, Forestry, and Animal Services		
Agriculture	C	Marijuana production.
	P	All other agriculture.
Forestry	P	
Agriculture and forestry services	P	
Keeping of livestock and other animals	C	The following keeping of livestock and other animal activities: <ul style="list-style-type: none"> ■ Animal shelters. ■ Boarding kennels. ■ Animal training facilities.
	N	All other keeping of livestock and other animals.
Animal services	C	Wildlife rehabilitation facilities.
	P	All other animal services.
Other Uses		
Home occupations	S	Home occupations, subject to SRC 700.020.

Accessory dwelling unit	S	Accessory dwelling units, subject to SRC 700.007.
-------------------------	---	---

(b) Continued uses. Existing single family and two family uses, other than manufactured dwellings, within the IC zone constructed prior to February 1, 1983, but which would otherwise be made nonconforming by this chapter, are hereby deemed continued uses.

- (1) Building or structures housing a continued use may be structurally altered or enlarged, or rebuilt following damage or destruction, provided such alteration, enlargement, or rebuilding complies with the standards set forth in SRC 551.010(g).
- (2) Cease of occupancy of a building or structure for a continued use shall not preclude future use of the building or structure for a residential use; provided, however, conversion of the building or structure to a nonresidential use shall thereafter prevent conversion back to a residential use.

Sec. 551.010. - Development standards.

Development within the IC zone must comply with the development standards set forth in this section.

- (a) *Lot standards.* Lots within the IC zone shall conform to the standards set forth in Table 551-2.

TABLE 551-2. LOT STANDARDS		
Requirement	Standard	Limitations & Qualifications
Lot Area		
All uses	None	
Lot Width		
All uses	None	
Lot Depth		
All uses	None	
Street Frontage		
Single Family	Min. 40 ft.	
	Min. 30 ft.	Applicable to lots fronting on the turnaround of a cul-de-sac street or the outside curve of curved street having a radius of 200 ft. or less and a direction change of 60 degrees or more. In no case shall the lot width be less than 40 ft. at the front building setback line.
All other uses	Min. 16 ft.	

- (b) *Setbacks.* Setbacks within the IC zone shall be provided as set forth in Tables 551-3 and 551-4.

TABLE 551-3. SETBACKS		
Requirement	Standard	Limitations & Qualifications
Abutting Street		
Buildings		
All uses	Min. 5 ft.	
Accessory Structures		
Accessory to single family, two family, <u>three family, four family,</u> and multiple family	None	Applicable to accessory structures not more than 4 ft. in height.
Accessory to single family, two family, <u>three family, four family,</u> and multiple family	Min. 5 ft.	Applicable to accessory structures greater than 4 ft. in height.
Accessory to all other uses	Min. 5 ft.	Not applicable to transit stop shelters.
Vehicle Use Areas		
All uses	Per SRC chapter 806	
Interior Front		
Buildings		
Single family, and two family, <u>three family, and four family</u>	None	
Multiple family	Min. 15 ft.	Required landscaping shall meet the Type C standard set forth in SRC chapter 807.
All other uses	Zone-to-zone setback (Table 551-4)	
Accessory Structures		
Accessory to single family, and two family, <u>three family, and four family</u>	Min. 5 ft.	
Accessory to multiple family	Min. 15 ft.	Required landscaping shall meet the Type C standard set forth in SRC chapter 807.
Accessory to all other uses	Zone-to-zone setback (Table 551-4)	
Vehicle Use Areas		

Single family, and two family, three family, and four family	Per SRC chapter 806	
Multiple family	Min. 15 ft.	Required landscaping shall meet the Type C standard set forth in SRC chapter 807.
All other uses	Zone-to-zone setback (Table 551-4)	
Interior Side		
Buildings		
Single family and two family	None	
<u>Three family and four family</u>	<u>Min. 5 ft.</u>	
Multiple family	Min. 15 ft.	Required landscaping shall meet the Type C standard set forth in SRC chapter 807.
All other uses	Zone-to-zone setback (Table 551-4)	
Accessory Structures		
Accessory to single family, and two family, three family, and four family	None	Applicable to accessory structures having at least 1 wall which is an integral part of a fence.
	Min. 5 ft.	Applicable to all other accessory structures.
Accessory to multiple family	Min. 15 ft.	Required landscaping shall meet the Type C standard set forth in SRC chapter 807.
Accessory to all other uses	Zone-to-zone setback (Table 551-4)	
Vehicle Use Areas		
Single family, and two family, three family, and four family	Per SRC chapter 806	
Multiple family	Min. 15 ft.	Required landscaping shall meet the Type C standard set forth in SRC chapter 807.
All uses	Zone-to-zone setback (Table 551-4)	
Interior Rear		

Buildings		
Single family, and two family, three family, and four family	None	
Multiple family	Min. 15 ft.	Required landscaping shall meet the Type C standard set forth in SRC chapter 807.
All other uses	Zone-to-zone setback (Table 551-4)	
Accessory Structures		
Accessory to single family, and two family, three family, and four family	None	Applicable to accessory structures not more than 9 ft. in height.
	Min. 1 ft. for each 1 ft. of height over 9 ft.	Applicable to accessory structures greater than 9 ft. in height.
	Min. 1 ft.	Applicable to accessory structures adjacent to an alley, unless a greater setback is required based on the height of the accessory structure.
Accessory to multiple family	Min. 15 ft.	Required landscaping shall meet the Type C standard set forth in SRC chapter 807.
Accessory to all other uses	Zone-to-zone setback (Table 551-4)	
Vehicle Use Areas		
Single family, and two family, three family, and four family	Per SRC chapter 806	
Multiple family	Min. 15 ft.	Required landscaping shall meet the Type C standard set forth in SRC chapter 807.
All other uses	Zone-to-zone setback (Table 551-4)	

TABLE 551-4. ZONE-TO-ZONE SETBACKS

Abutting Zone	Type of Improvement	Setback⁽¹⁾	Landscaping & Screening
EFU	Buildings and accessory structures	Min. 5 ft.	Type A
	Vehicle use areas		
Residential Zone	Buildings and accessory structures	Min. 30 ft.	Type C
	Vehicle use areas		
Mixed-Use Zone	Buildings and accessory structures	Min. 5 ft.	Type A
	Vehicle use areas		
Commercial Zone	Buildings and accessory structures	Min. 5 ft.	Type A
	Vehicle use areas		
Public Zone	Buildings and accessory structures	Min. 5 ft.	Type A
	Vehicle use areas		
Industrial and Employment Zone: EC, IC, IBC, and IP	Buildings and accessory structures	None	N/A
	Vehicle use areas	Min. 5 ft.	Type A
Industrial and Employment Zone: IG and II	Buildings and accessory structures	Min. 10 ft.	Type C
	Vehicle use areas		
Limitations and Qualifications ⁽¹⁾ Zone-to-zone setbacks are not required abutting an alley.			

(c) *Lot coverage; height.* Buildings and accessory structures within the IC zone shall conform to the lot coverage and height standards set forth in Table 551-5.

TABLE 551-5. LOT COVERAGE; HEIGHT		
Requirement	Standard	Limitations & Qualifications
Lot Coverage		
Buildings and Accessory Structures		
All uses	No Max.	

Height		
Buildings		
All uses	Max. 70 ft.	
Accessory Structures		
Accessory to single family, and two family, <u>three family, and four family</u>	Max. 15 ft.	
Accessory to all other uses	Max. 70 ft.	

- (d) *Landscaping.*
- (1) *Setbacks.* Required setbacks shall be landscaped. Landscaping shall conform to the standards set forth in SRC chapter 807.
 - (2) *Vehicle use areas.* Vehicle use areas shall be landscaped as provided under SRC chapters 806 and 807.
 - (3) *Development site.* A minimum of 15 percent of the development site shall be landscaped. Landscaping shall meet the Type A standard set forth in SRC chapter 807. Other required landscaping under the UDC, such as landscaping required for setbacks or vehicular use areas, may count towards meeting this requirement.
- (e) *Industrial performance standards.* Within the IC zone, no land or structure shall be used or occupied unless maintained and operated in continuing compliance with all applicable standards adopted by the Oregon Department of Environmental Quality (DEQ), including the holding of all licenses and permits required by DEQ regulations, local ordinance, and state and federal law.
- (f) *Additional standards for manufactured homes.* Manufactured homes shall, in addition to the development standards generally applicable in the IC zone, comply with the following:
- (1) Manufactured homes shall be multi-sectional and enclose a space of not less than 860 square feet.
 - (2) Manufactured homes shall be placed on an excavated and back-filled foundation, and enclosed continuously at the perimeter with material comparable to the predominant materials used in foundations of surrounding dwellings.
 - (3) Manufactured homes shall have a pitched roof, with a slope not less than a nominal three feet in height for each 12 feet in width.
 - (4) Manufactured homes shall have exterior siding and roofing which in color, material, and appearance is similar to the exterior siding and roofing commonly used on residential dwellings within the community, or which is comparable to the predominant materials used on surrounding dwellings.

- (5) Manufactured homes shall be certified by the manufacturer to have an exterior thermal envelope meeting performance standards equivalent to the performance standards required of single family dwellings constructed under the State Building Code as defined in ORS 455.010.
- (6) Manufactured homes shall have a garage or carport constructed of like materials.
- (g) *Development standards for continued uses.*
 - (1) *Buildings.* Buildings housing a continued use may be structurally altered or enlarged, or rebuilt following damage or destruction, provided such alteration, enlargement, or rebuilding conforms to development standards of the Single Family Residential (RS) Zone set forth in SRC chapter 511 and to all other applicable provisions of the UDC, except the lot size and dimensions standards in SRC chapter 511.
 - (2) *Accessory structures.* Existing accessory structures to a continued use may be structurally altered or enlarged, or rebuilt following damage or destruction, and new accessory structures to a continued use may be constructed, provided such alteration, enlargement, rebuilding, or new accessory structure construction conforms to the development standards of the Single Family Residential (RS) Zone set forth in SRC chapter 511, except the lot size and dimensions standards, and to all other applicable provisions of the UDC.
 - (3) *Option to rebuild in same location.* Notwithstanding SRC 551.010(g)(1) and (2), any building or accessory structure rebuilt following damage or destruction may either be located on the same location on the lot as the original building or structure, or in compliance with the setbacks of the Single Family Residential (RS) Zone set forth in SRC 511.010(b).

Sec. 551.015. - Design review.

Design review under SRC chapter 225 is required for development within the IC as follows:

- (a) Multiple family development shall be subject to design review according to ~~the multiple family design review guidelines or the multiple family design review standards set forth in SRC chapter 702.~~
- (b) Residential care with ~~five~~three or more self-contained dwelling units shall be subject to design review according to ~~the multiple family design review guidelines or the multiple family design review standards set forth in SRC chapter 702.~~

Sec. 552.005. - Uses.

- (a) The permitted (P), special (S), conditional (C), and prohibited (N) uses in the IBC zone are set forth in Table 552-1.

TABLE 552-1. USES		
Use	Status	Limitations & Qualifications
Household Living		
Single family	N	
Two family	N	

<u>Three family</u>	<u>N</u>	
<u>Four family</u>	<u>N</u>	
Multiple family	N	
Group Living		
Room and board	N	
Residential care	N	
Nursing care	N	
Lodging		
Short-term commercial lodging	P	Short-term commercial lodging, subject to SRC 552.005(b).
Long-term commercial lodging	N	
Nonprofit shelters	N	
Retail Sales and Service		
Eating and drinking establishments	P	Eating and drinking establishments are permitted, unless noted below, subject to SRC 552.005(b).
	N	Drive-in or drive-through facilities.
Retail sales	P	The following retail sales activities, subject to SRC 552.005(b): <ul style="list-style-type: none"> ■ Photocopying and blueprinting. ■ Office supplies.
	N	All other retail sales.
Personal services	N	
Postal services and retail financial services	P	Postal services and retail financial services are permitted, subject to SRC 552.005(b).
Business and Professional Services		
Office	P	
Audio/visual media production	P	Audio/visual media production, provided it is conducted within an enclosed building.
Laboratory research and testing	P	Laboratory research and testing, provided it is conducted within an enclosed building.
Motor Vehicle, Trailer, and Manufactured Dwelling Sales and Services		

Motor vehicle and manufactured dwelling and trailer sales	N	
Motor vehicle services	P	Gasoline service stations, subject to SRC 552.005(b).
	N	All other motor vehicle services.
Commercial parking	N	
Park-and-ride facilities	N	
Taxicabs and car services	N	
Heavy vehicle and trailer sales	P	Heavy equipment rental and leasing, subject to SRC 552.005(b).
	N	All other heavy vehicle and trailer sales.
Heavy vehicle and trailer service and storage	N	
Recreation, Entertainment, and Cultural Services and Facilities		
Commercial entertainment—indoor	P	Health clubs, gyms, and membership sports and recreation clubs, subject to SRC 552.005(b).
	N	All other commercial entertainment—indoor.
Commercial entertainment—outdoor	N	
Major event entertainment	N	
Recreational and cultural community services	N	
Parks and open space	P	
Nonprofit membership assembly	N	
Religious assembly	N	
Health Services		
Medical centers/hospitals	N	
Outpatient medical services and laboratories	P	Outpatient medical services and laboratories, subject to SRC 552.005(b).
Educational Services		
Day care	P	Child day care services, subject to SRC 552.005(b).

	N	All other day care.
Basic education	N	
Post-secondary and adult education	P	Post-secondary and adult education, subject to SRC 552.005(b).
Civic Services		
Governmental services	P	
Social services	N	
Governmental maintenance services and construction	N	
Public Safety		
Emergency services	P	Emergency services, subject to SRC 552.005(b).
Detention facilities	N	
Military installations	N	
Funeral and Related Services		
Cemeteries	N	
Funeral and cremation services	N	
Construction Contracting, Repair, Maintenance, and Industrial Services		
General repair services	P	General repair services, subject to SRC 522.005(b).
Building and grounds services and construction contracting	P	Buildings and grounds services and construction contracting, subject to SRC 552.005(b).
Cleaning plants	N	
Industrial services	P	Industrial services, subject to SRC 552.005(b).
Wholesale Sales, Storage, and Distribution		
General wholesaling	P	General wholesaling, provided it is conducted within an enclosed building.
Heavy wholesaling	P	Heavy wholesaling, provided it is conducted within an enclosed building.
Warehousing and distribution	P	Warehousing and distribution, provided it is conducted within an enclosed building.
Self-service storage	P	Self-service storage, provided it is conducted within an enclosed building.
Manufacturing		

General manufacturing	P	General manufacturing, provided it is conducted within an enclosed building. Retail sales of products manufactured on the site are permitted.
Heavy manufacturing	N	
Printing	P	Printing, provided it is conducted within an enclosed building. Retail sales of products produced on the site are permitted.
Transportation Facilities		
Aviation facilities	C	Helicopter landing areas, with or without passenger and freight terminal facilities.
	N	All other aviation facilities.
Passenger ground transportation facilities	P	Transit stop shelters.
	N	All other passenger ground transportation facilities.
Marine facilities	N	
Utilities		
Basic utilities	P	
Wireless communication facilities	Allowed	Wireless communication facilities are allowed, subject to SRC chapter 703.
Drinking water treatment facilities	C	
Power generation facilities	C	
Data center facilities	P	Data center facilities, provided they are conducted within an enclosed building.
Fuel dealers	P	Fuel dealers, subject to SRC 552.005(b).
Waste-related facilities	N	
Mining and Natural Resource Extraction		
Petroleum and natural gas production	N	
Surface mining	N	
Farming, Forestry, and Animal Services		
Agriculture	N	Marijuana production.
	P	All other agriculture.
Forestry	N	

Agriculture and forestry services	N	
Keeping of livestock and other animals	N	
Animal services	N	
Other Uses		
Home occupations	N	

(b) Limitations on uses. Where a use is allowed subject to the provisions of this subsection, the use shall conform to the following additional limitations:

- (1) The use shall be limited to no more than 10,000 square feet of total floor area per development site; provided, however:
 - (A) Short-term commercial lodging may accommodate up to 100 guest rooms per development site, regardless of total floor area.
 - (B) Health clubs, gyms, and membership sports and recreation clubs may occupy up to 50,000 square feet of total floor area per development site.

Sec. 553.005. - Uses.

(a) The permitted (P), special (S), conditional (C), and prohibited (N) uses in the IP zone are set forth in Table 553-1.

TABLE 553-1. USES		
Use	Status	Limitations and Qualifications
Household Living		
Single family	P	Dwelling unit for a caretaker on the premises being cared for or guarded.
	S	Manufactured home as a dwelling for a caretaker, subject to SRC 700.030.
	N	All other single family.
Two family	N	
<u>Three family</u>	<u>N</u>	
<u>Four family</u>	<u>N</u>	
Multiple family	N	
Group Living		
Room and board	N	
Residential care	N	

Nursing care	N	
Lodging		
Short-term commercial lodging	P	
Long-term commercial lodging	N	
Nonprofit shelters	N	
Retail Sales and Service		
Eating and drinking establishments	P	
Retail sales	P	Retail sales is permitted, provided that the total building floor area devoted to retail sales does not exceed 30 percent of the total floor area of all buildings on the development site and the products sold are primarily products manufactured on-site.
		Notwithstanding the above paragraph, the following retail sales activities are permitted without the above limitation and qualification: <ul style="list-style-type: none"> ■ News dealers and newsstands. ■ Tobacco stores and stands. ■ Caterers.
	N	All other retail sales.
Personal services	N	
Postal services and retail financial services	P	Banks, credit unions, and other customer oriented facilities for financial institutions.
	N	All other postal services and retail financial services.
Business and Professional Services		
Office	P	The following office activities: <ul style="list-style-type: none"> ■ Photofinishing laboratories. ■ Headquarters of banks and other financial institutions. ■ Insurance carriers and brokers. ■ Real estate. ■ Communication services. ■ Engineering, architectural, and surveying services. ■ Accounting services. ■ Management and public relations services. ■ Technical services provided by independent authors and artists.

		<ul style="list-style-type: none"> ■ Research. ■ Music publishing. ■ Actuarial consulting. ■ Environmental consultants. ■ Call centers. ■ Vocational trade schools.
	N	All other office.
Audio/visual media production	P	
Laboratory research and testing	P	
Motor Vehicle, Trailer, and Manufactured Dwelling Sales and Services		
Motor vehicle and manufactured dwelling and trailer sales	N	
Motor vehicle services	P	The following motor vehicle services activities: <ul style="list-style-type: none"> ■ Motorcycle repair. ■ Gasoline service stations.
	N	All other motor vehicle services.
Commercial parking	P	
Park-and-ride facilities	P	
Taxicabs and car services	N	
Heavy vehicle and trailer sales	N	
Heavy vehicle and trailer service and storage	P	
Recreation, Entertainment, and Cultural Services and Facilities		
Commercial entertainment—indoor	P	Health clubs, gyms, and membership sports and recreation clubs.
	N	All other commercial entertainment—indoor.
Commercial entertainment—outdoor	N	
Major event entertainment	N	

Recreational and cultural community services	N	
Parks and open space	P	
Nonprofit membership assembly	N	
Religious assembly	N	
Health Services		
Medical centers/hospitals	N	
Outpatient medical services and laboratories	N	
Educational Services		
Day care	P	Child day care services.
	N	All other day care.
Basic education	N	
Post-secondary and adult education	P	Vocational trade schools.
	N	All other post-secondary and adult education.
Civic Services		
Governmental services	N	
Social services	N	
Governmental maintenance services and construction	P	
Public Safety		
Emergency services	P	
Detention facilities	N	
Military installations	N	
Funeral and Related Services		
Cemeteries	N	
Funeral and cremation services	N	
Construction Contracting, Repair, Maintenance, and Industrial Services		
General repair services	P	

Building and grounds services and construction contracting	P	
Cleaning plants	P	
Industrial services	P	
Wholesale Sales, Storage, and Distribution		
General wholesaling	P	
Heavy wholesaling	C	The following heavy wholesaling activities: <ul style="list-style-type: none"> ■ Petroleum and petroleum products wholesalers. ■ Chemicals and allied products wholesalers. ■ Firearms wholesalers. ■ Wood products and timber wholesalers.
	N	All other heavy wholesaling.
Warehousing and distribution	P	
Self-service storage	P	
Manufacturing		
General manufacturing	P	
Heavy manufacturing	N	The following heavy manufacturing activities: <ul style="list-style-type: none"> ■ Petroleum and coal products manufacturing. ■ Primary metal manufacturing. ■ Cement and concrete product manufacturing. ■ Lime and gypsum product manufacturing.
	C	All other heavy manufacturing activities.
Printing	P	
Transportation Facilities		
Aviation facilities	C	Helicopter landing areas, with or without passenger and freight terminal facilities.
	N	All other aviation facilities.
Passenger ground transportation facilities	P	
Marine facilities	N	
Utilities		
Basic utilities	P	

Wireless communication facilities	Allowed	Wireless communication facilities are allowed, subject to SRC chapter 703.
Drinking water treatment facilities	C	
Power generation facilities	C	
Data center facilities	P	
Fuel dealers	N	
Waste-related facilities	P	Recycling depots.
	C	Solid waste transfer stations.
	N	All other waste-related facilities.
Mining and Natural Resource Extraction		
Petroleum and natural gas production	C	
Surface mining	N	
Farming, Forestry, and Animal Services		
Agriculture	C	Marijuana production.
	P	All other agriculture.
Forestry	P	
Agriculture and forestry services	N	
Keeping of livestock and other animals	C	
Animal services	C	
Other Uses		
Home occupations	S	Home occupations, subject to SRC 700.020.
Accessory dwelling units	S	Accessory dwelling units, subject to SRC 700.007.

(b) Continued uses. Existing single family and two family uses, other than manufactured dwellings, within the IP zone constructed prior to February 1, 1983, but which would otherwise be made nonconforming by this chapter, are hereby deemed continued uses.

- (1) Building or structures housing a continued use may be structurally altered or enlarged, or rebuilt following damage or destruction, provided such alteration, enlargement, or rebuilding complies with the standards set forth in SRC 553.010(g).

- (2) Cease of occupancy of a building or structure for a continued use shall not preclude future use of the building or structure for a residential use; provided, however, conversion of the building or structure to a nonresidential use shall thereafter prevent conversion back to a residential use.

Sec. 554.005. - Uses.

- (a) The permitted (P), special (S), conditional (C), and prohibited (N) uses in the IG zone are set forth in Table 554-1.

TABLE 554-1. USES		
Use	Status	Limitations & Qualifications
Household Living		
Single family	P	Dwelling unit for a caretaker on the premises being cared for or guarded.
	S	Manufactured home as a dwelling for a caretaker, subject to SRC 700.030.
	N	All other single family.
Two family	N	
<u>Three family</u>	<u>N</u>	
<u>Four family</u>	<u>N</u>	
Multiple family	N	
Group Living		
Room and board	N	
Residential care	N	
Nursing care	N	
Lodging		
Short-term commercial lodging	P	Short-term rentals.
	N	All other short-term commercial lodging.
Long-term commercial lodging	N	
Nonprofit shelters	N	
Retail Sales and Service		
Eating and drinking establishments	P	
Retail sales	P	The following retail sales activities: <ul style="list-style-type: none"> ■ Photocopying, duplicating, and blueprinting services. ■ Retail nurseries and lawn and garden supply

		stores. ■ Lumber and other building materials dealers.
	N	All other retail sales.
Personal services	P	The following personal services activities are permitted: ■ Laundromats. ■ Drycleaners.
	N	All other personal services.
Postal services and retail financial services	P	Banks, credit unions, and other customer-oriented facilities for financial institutions.
	N	All other postal services and retail financial services.
Business and Professional Services		
Office	P	The following office activities are permitted: ■ Headquarters of banks and other financial institutions. ■ Direct mail advertising services. ■ Commercial art and photography. ■ Secretarial and court reporting services. ■ Photo finishing laboratories. ■ Management and public relations services. ■ Outdoor advertising services. ■ Professional, business, or political membership organizations. ■ Arrangement of transportation. ■ Vocational trade schools. ■ Research. ■ Telecommunication services.
	N	All other office.
Audio/visual media production	P	
Laboratory research and testing	P	
Motor Vehicle, Trailer, and Manufactured Dwelling Sales and Services		
Motor vehicle and manufactured dwelling and trailer sales	N	The following motor vehicle and manufactured dwelling and trailer sales activities: ■ Automobile sales. ■ Manufactured dwelling sales. ■ Recreational vehicle sales, when the sales display area is greater than 5 acres in size.

	P	All other motor vehicle and manufactured dwelling and trailer sales.
Motor vehicle services	N	Gasoline service stations.
	P	All other motor vehicle services.
Commercial parking	P	
Park-and-ride facilities	P	
Taxicabs and car services	P	
Heavy vehicle and trailer sales	P	
Heavy vehicle and trailer service and storage	N	Truck stops.
	P	All other heavy vehicle and trailer service and storage.
Recreation, Entertainment, and Cultural Services and Facilities		
Commercial entertainment—indoor	P	Health clubs, gyms, and membership sports and recreation clubs.
	N	All other commercial entertainment—indoor.
Commercial entertainment—outdoor	N	
Major event entertainment	C	Race tracks.
	N	All other major event entertainment.
Recreational and cultural community services	N	
Parks and open space	P	
Nonprofit membership assembly	P	
Religious assembly	P	
Health Services		
Medical centers/hospitals	N	
Outpatient medical services and laboratories	N	
Educational Services		
Day care	P	Child day care services.
	N	All other day care.
Basic education	N	

Post-secondary and adult education	P	Vocational trade schools.
	N	All other post-secondary and adult education.
Civic Services		
Governmental services	N	
Social services	N	
Governmental maintenance services and construction	P	
Public Safety		
Emergency services	P	
Detention facilities	N	
Military installations	N	
Funeral and Related Services		
Cemeteries	N	
Funeral and cremation services	N	
Construction Contracting, Repair, Maintenance, and Industrial Services		
General repair services	P	
Building and grounds services and construction contracting	P	
Cleaning plants	P	
Industrial services	P	
Wholesale Sales, Storage, and Distribution		
General wholesaling	P	
Heavy wholesaling	S	Scrap and waste material wholesalers, subject to SRC 700.065.
	C	Chemicals and allied products wholesalers.
	P	All other heavy wholesaling.
Warehousing and distribution	P	
Self-service storage	P	
Manufacturing		
General manufacturing	P	
Heavy manufacturing	C	
Printing	P	

Transportation Facilities		
Aviation facilities	C	Helicopter landing areas, with or without passenger and freight terminal facilities.
	N	All other aviation facilities.
Passenger ground transportation facilities	P	
Marine facilities	P	The following marine facilities: <ul style="list-style-type: none"> ■ Water transportation of passengers. ■ Services incidental to water transportation services.
	N	All other marine facilities.
Utilities		
Basic utilities	P	
Wireless communication facilities	Allowed	Wireless communication facilities are allowed, subject to SRC chapter 703.
Drinking water treatment facilities	P	
Power generation facilities	P	
Data center facilities	N	
Fuel dealers	P	
Waste-related facilities	P	Recycling depots.
	C	Solid waste transfer stations.
	N	All other waste-related facilities.
Mining and Natural Resource Extraction		
Petroleum and natural gas production	C	
Surface mining	C	
Farming, Forestry, and Animal Services		
Agriculture	S	Marijuana production.
	P	All other agriculture.
Forestry	P	
Agriculture and forestry services	P	
Keeping of livestock and other animals	C	
Animal services	P	

Other Uses		
Home occupations	S	Home occupations, subject to SRC 700.020.
Accessory dwelling units	S	Accessory dwelling units, subject to SRC 700.007.

(b) Continued uses. Existing single family and two family uses, other than manufactured dwellings, within the IG zone constructed prior to February 1, 1983, but which would otherwise be made nonconforming by this chapter, are hereby deemed continued uses.

- (1) Building or structures housing a continued use may be structurally altered or enlarged, or rebuilt following damage or destruction, provided such alteration, enlargement, or rebuilding complies with the standards set forth in SRC 554.010(f).
- (2) Cease of occupancy of a building or structure for a continued use shall not preclude future use of the building or structure for a residential use; provided, however, conversion of the building or structure to a nonresidential use shall thereafter prevent conversion back to a residential use.

Sec. 555.005. - Uses.

The permitted (P), special (S), conditional (C), and prohibited (N) uses in the II zone are set forth in Table 555-1.

TABLE 555-1. USES		
Use	Status	Limitations & Qualifications
Household Living		
Single family	C	Dwelling unit for a caretaker on the premises being cared for or guarded.
	N	All other single family.
Two family	N	
<u>Three family</u>	<u>N</u>	
<u>Four family</u>	<u>N</u>	
Multiple family	N	
Group Living		
Room and board	N	
Residential care	N	
Nursing care	N	
Lodging		
Short-term commercial lodging	N	
Long-term commercial lodging	N	

Nonprofit shelters	N	
Retail Sales and Service		
Eating and drinking establishments	C	
Retail sales	N	
Personal services	N	
Postal services and retail financial services	P	Banks, credit unions, and other customer-oriented facilities for financial institutions.
	N	All other postal services and retail financial services.
Business and Professional Services		
Office	P	The following office activities: <ul style="list-style-type: none"> ■ Headquarters of banks and other financial institutions. ■ Telecommunication services.
	N	All other office.
Audio/visual media production	P	
Laboratory research and testing	N	
Motor Vehicle, Trailer, and Manufactured Dwelling Sales and Service		
Motor vehicle and manufactured dwelling and trailer sales	N	
Motor vehicle services	N	
Commercial parking	P	
Park-and-ride facilities	P	
Taxicabs and car services	N	
Heavy vehicle and trailer sales	P	
Heavy vehicle and trailer service and storage	P	
Recreation, Entertainment, and Cultural Services and Facilities		
Commercial entertainment—indoor	C	Night clubs.
	N	All other commercial entertainment—indoor.
Commercial entertainment—outdoor	N	

Major event entertainment	N	
Recreational and cultural community services	N	
Parks and open space	P	
Nonprofit membership assembly	N	
Religious assembly	N	
Health Services		
Medical centers/hospitals	N	
Outpatient medical services and laboratories	N	
Educational Services		
Day care	P	Child day care services.
	N	All other day care.
Basic Education	N	
Post-secondary and adult education	N	
Civic Services		
Governmental services	N	
Social services	N	
Governmental maintenance services and construction	N	
Public Safety		
Emergency services	P	
Detention facilities	N	
Military installations	N	
Funeral and Related Services		
Cemeteries	N	
Funeral and cremation services	N	
Construction Contracting, Repair, Maintenance, and Industrial Services		
General repair services	N	
	P	Utility storage yards.

Building and grounds services and construction contracting	N	All other buildings and grounds services and construction contracting.
Cleaning plants	N	
Industrial services	P	
Wholesale Sales, Storage, and Distribution		
General wholesaling	P	
Heavy wholesaling	P	
Warehousing and distribution	N	
Self-service storage	N	
Manufacturing		
General manufacturing	P	
Heavy manufacturing	P	
Printing	P	
Transportation Facilities		
Aviation facilities	C	Helicopter landing areas, with or without passenger and freight terminal facilities, are allowed conditionally.
	N	All other aviation facilities.
Passenger ground transportation facilities	P	Transit stop shelters.
	N	All other passenger ground transportation facilities.
Marine facilities	P	The following marine facilities: <ul style="list-style-type: none"> ■ Water transportation of passengers. ■ Services incidental to water transportation services.
	N	All other marine facilities.
Utilities		
Basic Utilities	P	
Wireless communication facilities	Allowed	Wireless communication facilities are allowed, subject to SRC chapter 703.
Drinking water treatment facilities	P	
Power generation facilities	P	
Data center facilities	N	

Fuel dealers	N	
Waste-related facilities	P	
Mining and Natural Resource Extraction		
Petroleum and natural gas production	C	
Surface mining	C	
Farming, Forestry, and Animal Services		
Agriculture	S	Marijuana production.
	P	All other agriculture
Forestry	P	
Agriculture and forestry services	N	
Keeping of livestock and other animals	P	Wholesaling of livestock, including operation of livestock auction markets.
	N	All other keeping of livestock and other animals.
Animal services	P	
Other Uses		
Home occupations	N	

Sec. 556.005. - Uses.

- (a) Except as otherwise provided in this section, the permitted (P), special (S), conditional (C), and prohibited (N) uses in the SCI zone are set forth in Table 556-1.

**TABLE 556-1
USES**

Table 556-1: Uses		
Use	Status	Limitations and Qualifications
Household Living		
Single family	P	Single family is permitted, provided that it is: <ul style="list-style-type: none"> ■ A dwelling unit for a caretaker on the premises being cared for or guarded; or ■ Part of a live-work development. For purposes of this qualification, live-work development means a dwelling unit that is located in the same building with a commercial or industrial use allowed in the SCI zone, is occupied by at least one person engaged in that commercial or industrial use, and

		each commercial or industrial business on the site is paired with no more than one live-work dwelling unit.
	S	Manufactured home as a dwelling for a caretaker, subject to SRC 700.030.
	N	All other single family
Two family	P	Two family is permitted, provided that it is part of a live-work development. For purposes of this qualification, live-work development means at that <u>each</u> dwelling unit that is located in the same building with a commercial or industrial use allowed in the SCI zone is occupied by at least one person engaged in that commercial or industrial use, and each commercial or industrial business on the site is paired with no more than one live-work dwelling unit.
	N	<u>All other two family</u>
<u>Three family</u>	P	<u>Three family is permitted, provided that it is part of a live-work development. For purposes of this qualification, live-work development means that each dwelling unit located in the same building with a commercial or industrial use allowed in the SCI zone is occupied by at least one person engaged in that commercial or industrial use, and each commercial or industrial business on the site is paired with no more than one live-work dwelling unit.</u>
	N	<u>All other three family</u>
<u>Four family</u>	P	<u>Four family is permitted, provided that it is part of a live-work development. For purposes of this qualification, live-work development means that each dwelling unit located in the same building with a commercial or industrial use allowed in the SCI zone is occupied by at least one person engaged in that commercial or industrial use, and each commercial or industrial business on the site is paired with no more than one live-work dwelling unit.</u>
	N	<u>All other four family</u>
Multiple family	P	Multiple family is permitted, provided that it is part of a live-work development. For purposes of this qualification, live-work development means at that <u>each</u> dwelling unit that is located in the same building with a commercial or industrial use allowed in the SCI zone, is occupied by at least one person engaged in that commercial or industrial use, and each commercial or industrial business on the site is paired with no more than one live-work dwelling unit.

	N	All other multiple family
Group Living		
Room and board	N	
Residential care	N	
Nursing care	N	
Lodging		
Short-term commercial lodging	P	Short term rentals
	N	All other short-term commercial lodging.
Long-term commercial lodging	N	
Non-profit shelters	N	
Retail Sales and Services		
Eating and drinking establishments	P	
Retail sales	P	Retail sales is permitted, provided that the total building floor area of all retail sales establishments on any one development site may not exceed 30 percent of the total floor area of all buildings on the development site. In addition, individual retail sales establishments must meet one of the following standards: 1) Do not exceed 10,000 square feet in building floor area; or 2) The establishment may exceed 10,000 square feet in building floor area, provided that the products sold are primarily products manufactured on-site.
Personal services	P	Personal services is permitted, provided that: ■ The total building floor area of all personal services establishments on any one development site may not exceed 30 percent of the total floor area of all buildings on the development site; and ■ In no case may a single personal services establishment exceed 10,000 square feet in building floor area.
Postal services and retail financial services	P	Postal services and retail financial services is permitted, provided that: ■ The total building floor area of all postal services and retail financial services establishments on any one development site may not exceed 30 percent of the total floor area of all buildings on the development site; and

		<ul style="list-style-type: none"> ■ In no case may a single postal services and retail financial services establishment exceed 10,000 square feet in building floor area.
Business and Professional Services		
Office	P	<p>Office is permitted, provided that:</p> <ul style="list-style-type: none"> ■ The total building floor area of all office establishments on any one development site may not exceed 30 percent of the total floor area of all buildings on the development site; and ■ In no case may a single office establishment exceed 10,000 square feet in building floor area.
Audio/visual media production	P	
Laboratory research and testing	P	
Motor Vehicle, Trailer, and Manufactured Dwelling Sales and Service		
Motor vehicle and manufactured dwelling and trailer sales	N	
Motor vehicle services	N	Gasoline service stations
	P	All other motor vehicle services.
Commercial parking	P	
Park-and-ride facilities	P	
Taxicabs and car services	P	
Heavy vehicle and trailer sales	N	
Heavy vehicle and trailer service and storage	N	Truck stops
	P	All other heavy vehicle and trailer service and storage.
Recreation, Entertainment, and Cultural Services and Facilities		
Commercial entertainment—indoor	P	<p>The following commercial entertainment—indoor activities:</p> <ul style="list-style-type: none"> ■ Health clubs and gyms ■ Entertainment establishments. ■ Membership sports and recreation clubs.
	N	All other commercial entertainment—indoor.
	P	<p>The following commercial entertainment—outdoor activities:</p> <ul style="list-style-type: none"> ■ Membership sports and recreation clubs.

Commercial entertainment—outdoor	N	All other commercial entertainment—outdoor.
Major event entertainment	N	
Recreational and cultural community services	P	The following recreational and cultural community services activities: <ul style="list-style-type: none"> ■ Art museums and art centers ■ Museums
	N	All other recreational and cultural community services
Parks and open space	P	
Non-profit membership assembly	P	
Religious assembly	P	
Health Services		
Medical centers/hospitals	N	
Outpatient medical services and laboratories	P	
Educational Services		
Day care	P	Child day care services
	N	All other day care
Basic education	N	
Post-secondary and adult education	P	Vocational trade schools
	N	All other post-secondary and adult education
Civic Services		
Governmental services	P	
Social services	N	
Governmental maintenance services and construction	P	
Public Safety		
Emergency services	P	
Detention facilities	N	

Military installations	N	
Funeral and Related Services		
Cemeteries	N	
Funeral and cremation services	N	
Construction Contracting, Repair, Maintenance, and Industrial Services		
General repair services	P	
Building and grounds services and construction contracting	N	The following buildings and grounds services and construction contracting activities: <ul style="list-style-type: none"> ■ Disinfecting and pest control services ■ Building cleaning and maintenance services.
	P	All other buildings and grounds services and
Construction Contracting		
Cleaning plants	P	
Industrial services	P	
Wholesale Sales, Storage, and Distribution		
General wholesaling	P	
Heavy wholesaling	N	The following heavy wholesaling activities: <ul style="list-style-type: none"> ■ Scrap and waste materials. ■ Chemicals and allied products
	P	All other heavy wholesaling
Warehousing and distribution	P	
Self-service storage	P	
Manufacturing		
General manufacturing	N	The following general manufacturing activities are prohibited: <ul style="list-style-type: none"> ■ Paperboard containers and boxes. ■ Paper bag and coated and treated paper manufacturing. ■ Drugs, cleaning agents, and personal care products. ■ Batteries. ■ Sign manufacturing
	P	All other general manufacturing.
Heavy manufacturing	N	The following heavy manufacturing activities are prohibited: <ul style="list-style-type: none"> ■ Animal slaughtering and processing. ■ Pulp, paper, and paperboard mills. ■ Sawmills.

		<ul style="list-style-type: none"> ■ Chemical manufacturing. ■ Petroleum and coal products. ■ Cement and concrete products. ■ Foundries, smelting, and other similar activities. ■ Ordnance, small arms, and ammunition.
	C	All other heavy manufacturing.
Printing	P	
Transportation Facilities		
Aviation facilities	N	
Passenger ground transportation facilities	P	
Marine facilities	N	
Utilities		
Basic utilities	P	
Wireless communication facilities	Allowed	Wireless communication facilities are allowed, subject to SRC chapter 703.
Drinking water treatment facilities	P	
Power generation facilities	P	
Data center facilities	N	
Fuel dealers	N	
Waste-related facilities	P	Recycling depots
	N	All other waste-related facilities
Mining and Natural Resource Extraction		
Petroleum and natural gas production	N	
Surface mining	N	
Farming, Forestry, and Animal Services		
Agriculture	N	
Forestry	N	
Agriculture and forestry services	N	

Keeping of livestock and other animals	N	
Animal services	P	

(b) *Prohibited uses.* Notwithstanding Table 556-1, any permitted, special, or conditional use within the SCI zone shall be a prohibited use if developed with a drive-through.

Sec. 556.010. - Development standards.

Development within the SCI zone must comply with the development standards set forth in this section.

- (a) *Continued development.* Buildings and structures existing within the SCI zone on June 13, 2018, which would otherwise be made non-conforming by this chapter, are hereby deemed continued development. Continued development may be structurally altered, enlarged, or rebuilt following damage or destruction, provided such alteration, enlargement, or rebuilding conforms to the following standards:
 - (1) *Minor alterations.* Exterior alterations to buildings that alter an existing building facade area facing Second Street NW by less than 20 percent are exempt from all of the development standards in this chapter. Such alterations shall not increase the building facade's nonconformity to the design standards of SRC 556.020.
 - (2) *Minor additions.* Additions to buildings that alter or enlarge an existing building facade area facing Second Street NW by less than 20 percent are exempt from all of the development standards in this chapter except for street frontage, setbacks abutting streets other than Second Street, interior setbacks, parking, landscaping, and maximum height standards. Such additions shall not increase the building facade's nonconformity to the design standards of SRC 556.020.
 - (3) *Major alterations.* Exterior alterations to buildings that alter an existing building facade area facing Second Street NW by between 20 percent and 60 percent shall decrease that building facade's nonconformity to all design standards of SRC 556.020. Such alterations are exempt from all other development standards in this chapter.
 - (4) *Major additions.* Additions to buildings that enlarge an existing building facade area facing Second Street NW by between 20 percent and 60 percent shall comply with at least two of the three design standards of SRC 556.020. Major additions must meet all other development standards in this chapter except for setback abutting a street and the parking location standard of SRC 556.010(i).
 - (5) *Substantial alterations.* Exterior alterations to buildings that alter an existing building facade area facing Second Street NW by more than 60 percent shall meet all applicable design standards of SRC 556.020. Such alterations are exempt from all other development standards in this chapter.
 - (6) *Substantial additions or redevelopment.* Additions to buildings that enlarge an existing building facade area facing Second Street NW by more than 60 percent shall meet all applicable development and design standards in this chapter.

Continued development that is rebuilt following damage or destruction shall meet all development design standards in this chapter.

- (b) *Grade separated street frontage.* Portions of property street frontage that are separated from the grade of the street with a road ramp above the grade of the property line abutting the street are exempt from setbacks abutting a street, off-street parking location, and design review requirements.
- (c) *Lot standards.* Lots within the SCI zone shall conform to the standards set forth in Table 556-2.

**TABLE 556-2
LOT STANDARDS**

Table 556-2: Lot Standards		
Requirement	Standard	Limitations and Qualifications
LOT AREA		
All uses	None	
LOT WIDTH		
All uses	None	
LOT DEPTH		
All uses	None	
STREET FRONTAGE		
All other uses	Min. 16 ft.	

- (d) *Setbacks.* Setbacks within the SCI zone shall be provided as set forth in Table 556-3.

**TABLE 556-3
SETBACKS**

Table 556-3: Setbacks		
Requirement	Standard	Limitations and Qualifications
ABUTTING STREET		
Buildings and Accessory Structures		
All uses	0 ft.	Applicable to Second Street NW.
		Setback greater than 0 feet, up to a maximum of 10 feet, is permitted if the space is used for pedestrian amenities.

		Not applicable to transit stop shelters.
	None	Applicable to all other abutting streets.
		Not applicable to transit stop shelters.
Vehicle Use Areas		
All uses	Per SRC chapter 806	
INTERIOR FRONT		
Buildings		
All uses	Zone-to-zone setback (Table 556-4)	
Accessory Structures		
Accessory to all uses	Zone-to-zone setback (Table 556-4)	
Vehicle Use Areas		
All uses	Per SRC chapter 806	
INTERIOR SIDE		
Buildings		
All uses	Zone-to-zone setback (Table 556-4)	
Accessory Structures		
Accessory to all uses	Zone-to-zone setback (Table 556-4)	
Vehicle Use Areas		
All uses	Zone-to-zone setback (Table 556-4)	
INTERIOR REAR		
Buildings		

All uses	Zone-to-zone setback (Table 556-4)	
Accessory Structures		
Accessory to all uses	Zone-to-zone setback (Table 556-4)	
Vehicle Use Areas		
All uses	Zone-to-zone setback (Table 556-4)	

**TABLE 556-4
ZONE-TO-ZONE SETBACKS**

Table 556-4: Zone-to-Zone Setbacks			
Abutting Zone	Type of Improvement	Setback (1)	Landscaping and Screening
EFU	Buildings and accessory structures	Min. 10 ft.	Type A
	Vehicle use areas		
Residential zone	Buildings and accessory structures	Min. 40 ft.	Type B
	Vehicle use areas		
Mixed-use zone	Buildings and accessory structures	None	NA
	Vehicle use areas	Min. 5 ft.	Type A
Commercial zone	Buildings and accessory structures	None	NA
	Vehicle use areas	Min. 5 ft.	Type A
Public zone	Buildings and accessory structures	None	NA
	Vehicle use areas	Min. 5 ft.	Type A
Industrial and Employment Zone: EC, IC, IBC, and IP	Buildings and accessory structures	None	

	Vehicle use areas	Min. 5 ft.	Type A
Industrial and Employment Zone: IG and II	Buildings and accessory structures	None	
	Vehicle use areas	Min. 5 ft.	Type A
Limitations and Qualifications			
(1) Zone-to-zone setbacks are not required abutting an alley.			

- (e) *Lot coverage; height.* Buildings and accessory structures within the SCI zone shall conform to the lot coverage and height standards set forth in Table 556-5.

**TABLE 556-5
LOT COVERAGE; HEIGHT**

Table 556-5: Lot Coverage; Height		
Requirement	Standard	Limitations and Qualifications
LOT COVERAGE		
Buildings and Accessory Structures		
All uses	No Max.	
REAR YARD COVERAGE		
Buildings		
All uses	No max.	
Accessory Structures		
Accessory to all uses	No max.	
HEIGHT		
Buildings		
All uses	Max. 70 ft.	
Accessory Structures		
Accessory to single family, two family, <u>three family</u> , <u>four family</u> , and multiple family	Max. 15 ft.	
Accessory to all other uses	Max. 70 ft.	

- (f) *Landscaping.* Landscaping within the SCI zone shall be provided as set forth in this subsection.
- (1) *Setbacks.* Required setbacks shall be landscaped. Landscaping shall conform to the standards set forth in SRC chapter 807.
 - (2) *Vehicle use areas.* Vehicle use areas shall be landscaped as provided under SRC chapter 806 and SRC chapter 807.
- (g) *Pedestrian access.* All development, other than development of single family, ~~and two family, three family, and four family~~ uses, shall comply with the following pedestrian access standards:
- (1) A pedestrian connection shall be provided from the public sidewalk to the primary building entrance.
 - (2) A pedestrian connection through the parking area to the primary building entrance shall be provided when that parking area contains more than 12 parking spaces.
 - (3) On development sites with multiple buildings, pedestrian connections shall be provided to connect the buildings. Pedestrian connections shall be the most practical, direct route.
 - (4) Pedestrian connections shall be paved, a minimum of five feet in width, and defined by visual contrast or tactile finish texture.
 - (5) Wheel stops or extended curbs shall be provided along required pedestrian connections to prevent the encroachment of vehicles onto pedestrian connections.
- (h) *Project enhancements.* Development within the SCI zone shall include two or more of the following project enhancements:
- (1) Joint parking agreement under SRC 806.020(a)(5), or implementation of a plan to satisfy off-street parking requirements through alternative modes of transportation under SRC 806.015(e)(2);
 - (2) Construction of a building placed no more than ten feet from the right-of-way line of a public street other than Second Street NW, for a minimum of 50 percent of the building facade facing the street;
 - (3) Reuse of a portion of an existing building that is sited no more than ten feet from the right-of-way line of a public street, that incorporates a building entrance available for use by the public with a direct connection to the public sidewalk on that street;
 - (4) Ground floor building facades facing a street other than Second Street NW include transparent windows on a minimum of 50 percent of the ground floor facade area. The windows shall not be mirrored or treated in such a way as to block visibility into the building. The windows shall have a minimum visible transmittance (VT) of 37 percent;
 - (5) Ground floor building facades facing a street other than Second Street NW include weather protection, in the form of awnings or canopies, along more than 50 percent of the length of the ground floor building facade adjacent to sidewalks or pedestrian connections fronting the street;

- (6) The development site includes no off-street parking areas located between buildings and streets;
- (7) Replacement of existing surface parking areas with new development of buildings or structures;
- (8) Construction of one or more buildings at least two stories in height;
- (i) *Off-street parking location.* Off-street surface parking areas and vehicle maneuvering areas shall not be located between a building or structure and Second Street NW.
- (j) *Industrial performance standards.* Within the SCI zone, no land or structure shall be used or occupied unless maintained and operated in continuing compliance with all applicable standards adopted by the Oregon Department of Environmental Quality (DEQ), including the holding of all licenses and permits required by DEQ regulation, local ordinance, and state and federal law.

Sec. 603.020. - Development standards.

Development within the Portland/Fairgrounds Road Overlay Zone must comply with the development standards applicable in the underlying zone and the development standards set forth in this section. The development standards in this section are in addition to, and not in lieu of, all other applicable development standards in the underlying zone. Where the development standards in this section conflict with the development standards applicable in the underlying zone, the development standards in this section shall be the applicable development standard.

- (a) *Continued development.* Building and structures existing within the Portland/Fairgrounds Road Overlay Zone that conformed to the development standards existing on October 1, 2001, but which would otherwise be made nonconforming development by this chapter, are hereby deemed continued development. The owner shall have the burden to demonstrate continued development status under this subsection.
 - (1) Continued development may be enlarged, rebuilt, or the exterior altered, provided such enlargement, rebuilding, or exterior alteration complies with all applicable standards in the underlying zone.
 - (2) Continued development may be extended onto any contiguous vacant land under the same ownership if such land was held under the same ownership on October 1, 2001, and has been maintained under the same ownership continuously thereafter. The extension of continued development onto contiguous vacant land under the same ownership must comply with all applicable standards in the underlying zone.
 - (3) A determination by the Building Official that a continued development is derelict or dangerous, as defined in SRC 50.600 and 56.230, shall terminate the continued development status conferred by this subsection and the building or structure shall thereafter be deemed a nonconforming development.
- (b) *Lot standards.* Lots for townhouses within the Portland/Fairgrounds Road Overlay Zone shall conform to the standards set forth in Table 603-2.

TABLE 603-2. LOT STANDARDS

Requirement	Standard	Limitations & Qualifications
Lot Area		
Single family	Min. 1,500 sq. ft.	Applicable to townhouses.
Lot Width		
Single family	Min. 20 ft.	Applicable to townhouses.
Lot Depth		
Single family	Min. 65 ft.	Applicable to townhouses.

- (c) *Dwelling unit density.* Dwelling unit density within the Portland/Fairgrounds Overlay Zone shall conform to the standards set forth in Table 603-3. Dwelling unit density cannot be varied or adjusted.

TABLE 603-3. DWELLING UNIT DENSITY		
Use or Activity	Standard	Limitations & Qualifications
Single family, two family, <u>three family, four family,</u> and multiple family	Min. 20 dwelling units per acre	
	None	Applicable to mixed-use buildings where floors above the first floor are used entirely for dwelling units.

- (d) *Setbacks.* Setbacks within the Portland/Fairgrounds Road Overlay Zone shall be provided as set forth in Table 603-4.

TABLE 603-4. SETBACKS		
Requirements	Standards	Limitations & Qualifications
Abutting Street		
Buildings		
Single family, two family, <u>three family, four family,</u> and multiple family	Min. 12 ft., plus 1 ft. for each 1 ft. of height over 12 ft.	
	Max. 20 ft.	
Accessory Structures		
Accessory to single family, two family, <u>three family, four family,</u> and multiple family	None	Applicable to accessory structures not more than 4 ft. in height.
	Min. 12 ft., plus 1 ft. for each 1 ft. of height over 12 ft.	Applicable to accessory structures greater than 4 ft. in height.

Interior Front		
Buildings		
Single family and two family, three family, and four family	Min. 12 ft., plus 1 ft. for each 1 ft. of height over 12 ft.	
Accessory Structures		
Accessory to single family, and two family, three family, and four family	None	Applicable to accessory structures not more than 4 ft. in height.
	Min. 12 ft., plus 1 ft. for each 1 ft. of height over 12 ft.	Applicable to accessory structures greater than 4 ft. in height.
Interior Side		
Buildings		
Single family, and two family, three family, and four family	Min. 5 ft.	
	None	Applicable to townhouses.
Accessory Structures		
Accessory to single family, and two family, three family, and four family	None	Applicable to accessory structures having at least 1 wall which is an integral part of a fence.
	Min. 5 ft.	Applicable to all other accessory structures.
Interior Rear		
Buildings		
Single family, and two family, three family, and four family	Min. 14 ft.	Applicable to any portion of a building not more than 1 story in height.
	Min. 20 ft.	Applicable to any portion of a building greater than 1 story in height.
Accessory Structures		
Accessory to single family, and two family, three family, and four family	None	Applicable to accessory structures not more than 9 ft. in height.
	Min. 1 ft. for each 1 ft. of height over 9 ft.	Applicable to accessory structures greater than 9 ft. in height.
	Min. 1 ft.	Applicable to accessory structures adjacent to an alley, unless a greater

		setback is required based on the height of the accessory structure.
--	--	---

- (e) *Landscaping.* Berms, mounds, raised beds, and grade drops shall not be allowed as a landscaping treatment, unless a bioswale treatment system or approved landscaping exists to adequately collect water runoff and the berms, mounds, raised beds, and grade drops do not exceed a 3:1 slope.
- (f) *Off-street parking and loading areas.*
 - (1) Planter bays or islands shall have a minimum planting area of 50 square feet.
 - (2) A minimum of one tree per eight parking spaces is required, of which a maximum of 25 percent may be evergreen trees. Trees shall be planted within 20 feet of the parking lot perimeter. Trees within the public street right-of-way shall not count toward the tree planting requirements.
 - (3) Off-street parking may be provided no more than 800 feet from the edge of the lot, or contiguous lots, upon which the main building is located.
 - (4) Employee off-street parking may be provided no more than 2,000 feet from the edge of the lot, or contiguous lots, upon which the main building is located.
 - (5) Parking lot light structures shall not exceed 25 feet in height.
- (g) *Screening.*
 - (1) Trash receptacles shall be screened from adjacent household living uses and streets by a sight-obscuring fence, wall, or hedge.
 - (2) Concertina or barbed wire fencing shall not be located within 60 feet of the street right-of-way, unless such fencing is obstructed by a building or structure.
 - (3) Concertina or barbed wire fencing shall be screened from public view and adjacent property by sight-obscuring landscaping.
- (h) *Outdoor storage.*
 - (1) Outdoor storage areas shall not be located within required setbacks.
 - (2) Outdoor storage areas shall be enclosed by a minimum six-foot-high sight-obscuring fence, wall, hedge, or berm; provided, however, items more than six feet in height above grade shall be screened by sight-obscuring landscaping.
 - (3) Items stored within outdoor storage areas shall not exceed a maximum height of 14 feet above grade.
- (i) *Pedestrian access.*
 - (1) A pedestrian connection shall be provided from the public sidewalk to the primary building entrance.
 - (2) A pedestrian connection through the parking area to the primary building entrance shall be provided when the parking area is greater than 60 feet in depth.

- (3) Within shopping centers, office complexes, and mixed-use developments, pedestrian connections shall be provided to connect the buildings. Pedestrian connections shall be the most practical, direct route.
 - (4) Pedestrian connections shall be a minimum of five feet in width, and defined by visual contrast or tactile finish texture.
 - (5) Wheel stops or extended curbs shall be provided along required pedestrian connections to prevent the encroachment of vehicles onto pedestrian connections.
- (j) *Project enhancements.* Development within the Portland/Fairgrounds Road Overlay Zone shall include four or more of the following project enhancements:
- (1) Closure of one driveway approach on Portland/Fairgrounds Road;
 - (2) Joint parking agreement under SRC 806.020(a)(5), or implementation of a plan to satisfy off-street parking requirements through alternative modes of transportation under SRC 806.015(e)(2);
 - (3) Freestanding sign not more than five feet in height and placed upon a foundation;
 - (4) Weather protection, in the form of awnings or canopies, along more than 50 percent of the length of the ground floor building facade adjacent to sidewalks or pedestrian connections;
 - (5) Cast iron or wrought iron fencing adjacent to Portland/Fairgrounds Road;
 - (6) Pedestrian connections that are:
 - (A) Constructed with pavers, scored or colored cement, and/or stamped asphalt;
 - (B) Elevated above the parking area and driveway; or
 - (C) Defined with landscaping or building features such as canopies, awnings, or arcades;
 - (7) Development on surface parking lots existing on October 1, 2001;
 - (8) Provision of one or more of the following pedestrian-oriented design features on private property adjacent to Portland/Fairgrounds Road:
 - (A) Pedestrian scale lighting not more than 16 feet in height; or
 - (B) Plazas or other outdoor spaces open to the public;
 - (9) A minimum of seven percent interior landscaping within parking areas not more than 50,000 square feet in size; or a minimum of ten percent interior landscaping within parking areas greater than 50,000 square feet in size;
 - (10) Installation of landscaping and irrigation using a plan designed by an Oregon landscape architect;
 - (11) Development of a mixed-use building; or
 - (12) Construction of a building where at least 50 percent of the building frontage is constructed contiguous to the minimum building setback line.

Sec. 603.025. - Design review.

Design review under SRC chapter 225 is required for development within the Portland/Fairgrounds Road Overlay Zone as follows:

- (a) Except as otherwise provided in this section, design review according to the design review guidelines or the design review standards set forth in SRC 603.030 is required for all development within the Portland/Fairgrounds Road Overlay Zone.
- (b) Multiple family development, other than multiple family development within a mixed-use building, shall only be subject to design review according to ~~the multiple family design review guidelines or the multiple family design review standards~~ set forth in SRC chapter 702.
- (c) Multiple family development within a mixed-use building shall only be subject to design review according to the design review guidelines or the design review standards set forth in SRC 603.030.
- (d) Any development requiring historic design review shall only be subject to design review according to the historic design review standards or the historic design review guidelines set forth in SRC chapter 230.

Sec. 604.015. - Uses.

- (a) *General.* Except as otherwise provided in this section, the uses set forth in Table 604-1 shall be the only permitted (P), special (S), conditional (C), and prohibited (N) uses in the Pine Street Mixed-Use Overlay Zone.

TABLE 604-1. USES			
Use	Status		Limitations & Qualifications
	CG Underlying Zone	IC Underlying Zone	
Household Living			
Single family	P	C	The following single family activities: <ul style="list-style-type: none"> ■ Townhouse. ■ Residential home, as defined under ORS 197.660.
	N	P	Dwelling unit for a caretaker or watchperson on the premises being cared for or guarded.
	N	N	All other single family.
Two family	N	C	
<u>Three family</u>	<u>P</u>	<u>S</u>	<u>Three family, constructed as part of a mixed-use development, subject to SRC 700.081.</u>
	<u>S</u>	<u>S</u>	<u>All other three family, subject to SRC 700.081.</u>

Four family	P	S	Four family, constructed as part of a mixed-use development, subject to SRC 700.081.
	S	S	All other four family, subject to SRC 700.081.
Multiple family	P	C	Multiple family, constructed as part of a mixed-use development.
	C	C	All other multiple family.
Group Living			
Room and board	P	C	Room and board serving 5 or fewer persons.
	C	N	Room and board serving 6 to 75 persons.
	N	N	All other room and board.
Residential care	C	C	
Nursing care	P	P	
Lodging			
Short-term commercial lodging	P	P	
Long-term commercial lodging	N	C	
Nonprofit shelters	C	C	Nonprofit shelters serving 5 or fewer persons.
	N	N	All other nonprofit shelters.
Retail Sales and Services			
Eating and drinking establishments	P	P	
Retail sales	N	N	Used merchandise stores, where sales and storage of merchandise and equipment is not conducted entirely within a building.
	N	P	The following retail sales activities: <ul style="list-style-type: none"> ■ Auto supply stores. ■ Meat and seafood markets where live animals are sold or processed.
	P	P	All other retail sales.
Personal services	P	P	

Postal services and retail financial services	P	P	
Business and Professional Services			
Office	P	P	
Audio/visual media production	P	P	
Laboratory research and testing	P	P	
Motor Vehicle, Trailer, and Manufactured Dwelling Sales and Service			
Motor vehicle and manufactured dwelling and trailer sales	C	C	
Motor vehicle services	C	C	
Commercial parking	P	P	
Park-and-ride facilities	P	P	
Taxicabs and car services	N	P	
Heavy vehicle and trailer sales	N	N	
Heavy vehicle and trailer service and storage	N	N	
Recreation, Entertainment, and Cultural Services and Facilities			
Commercial entertainment—indoor	C	C	Nightclubs, located within 200 feet of a residential zone.
	P	P	All other commercial entertainment—indoor.
Commercial entertainment—outdoor	N	N	
Major event entertainment	N	N	
Recreational and cultural community services	P	P	

Parks and open space	P	P	
Nonprofit membership assembly	P	P	
Religious assembly	P	P	
Health Services			
Medical centers/hospitals	N	N	
Outpatient medical services and laboratories	P	P	
Educational Services			
Day care	P	P	
Basic education	P	P	
Post-secondary and adult education	P	P	
Civic Services			
Governmental services	P	P	
Social services	P	P	
Governmental maintenance services and construction	N	N	
Public Safety			
Emergency services	P	P	
Detention facilities	N	N	
Military installations	P	P	
Funeral and Related Services			
Cemeteries	N	N	
Funeral and cremation services	P	P	
Construction Contracting, Repair, Maintenance, and Industrial Services			
General repair services	P	P	
Building and grounds services and	N	N	

construction contracting			
Cleaning plants	N	N	Industrial laundries.
	P	P	All other cleaning plants.
Industrial services	N	N	
Wholesale Sales			
General wholesaling	P	P	General wholesaling, provided 40 percent or more of the building square footage is dedicated to the sale of merchandise for household or personal consumption by the general public.
Heavy wholesaling	N	N	
Warehousing and distribution	N	N	
Self-service storage	N	N	
Manufacturing			
General manufacturing	C	P	General manufacturing, provided 40 percent or more of the building square footage is dedicated to the sale of merchandise for household or personal consumption by the general public.
Heavy manufacturing	N	N	
Printing	P	P	
Transportation Facilities			
Aviation facilities	N	N	
Passenger ground transportation facilities	P	P	
Marine facilities	N	N	
Utilities			
Basic utilities	P	P	
Wireless communication facilities	Allowed	Allowed	Wireless communication facilities are allowed, subject to SRC chapter 703.

Drinking water treatment facilities	N	C	
Power generation facilities	N	N	
Data center facilities	N	N	
Fuel dealers	N	N	
Waste-related facilities	N	N	
Mining and Natural Resource Extraction			
Petroleum and natural gas production	N	N	
Surface mining	N	N	
Farming, Forestry, and Animal Services			
Agriculture	N	N	
Forestry	N	N	
Agriculture and forestry services	N	N	
Keeping of livestock and other animals	N	N	
Animal services	P	P	Small animal veterinary services.
	C	C	Wildlife rehabilitation facility.
	N	N	All other animal services.
Other Uses			
Home occupations	S	S	Home occupations are allowed, subject to SRC 700.020.

- (b) *Additional conditional uses.* In addition to the uses set forth in Table 604-1, any permitted, special, or conditional use within the Pine Street Mixed-Use Overlay Zone shall be a conditional use within the overlay zone if developed with any of the following:
- (1) Drive-through;
 - (2) Outside storage and parking of professional and commercial equipment; or
 - (3) Loading of commercial vehicles over 20,000 pounds of gross vehicle weight.
- (c) *Continued uses.* Uses existing within the Pine Street Mixed-Use Overlay Zone that were allowed as permitted, special, or conditional uses on October 1, 2001, but which would

otherwise be made nonconforming uses by this chapter, are hereby deemed continued uses. The owner shall have the burden to demonstrate continued use status under this subsection.

- (1) A continued use may be intensified, and buildings or structures housing a continued use may be enlarged, rebuilt, or the exterior altered, provided such intensification, enlargement, rebuilding, or exterior alteration complies with all applicable standards in the underlying zone.
- (2) A continued use may be extended onto any contiguous vacant land under the same ownership if such land was held under the same ownership on October 1, 2001, and has been maintained under the same ownership continuously thereafter. The extension of a continued use onto contiguous vacant land under the same ownership must comply with all applicable standards in the underlying zone.
- (3) A continued use may be changed to any use that is allowed in the Pine Street Mixed-Use Overlay Zone. Such change of use shall terminate the continued use status conferred by this subsection and the property must thereafter only be used for uses allowed in the Pine Street Mixed-Use Overlay Zone.
- (4) A determination by the Building Official that the building or structure housing a continued use is derelict or dangerous, as defined in SRC 50.600 and 56.230, shall terminate the continued use status conferred by this subsection and the property may thereafter only be used for uses allowed in the Pine Street Mixed-Use Overlay Zone.

Sec. 604.020. - Development standards.

Development within the Pine Street Mixed-Use Overlay Zone must comply with the development standards applicable in the underlying zone and the development standards set forth in this section. The development standards in this section are in addition to, and not in lieu of, all other applicable development standards in the underlying zone. Where the development standards in this section conflict with the development standards applicable in the underlying zone, the development standards in this section shall be the applicable development standard.

- (a) *Continued development.* Buildings and structures existing within the Pine Street Mixed-Use Overlay Zone that conformed to the development standards existing on October 1, 2001, but which would otherwise be made nonconforming development by this chapter, are hereby deemed continued development. The owner shall have the burden to demonstrate continued development status under this subsection.
 - (1) Continued development may be enlarged, rebuilt, or the exterior altered, provided such enlargement, rebuilding, or exterior alteration complies with all applicable standards in the underlying zone.
 - (2) Continued development may be extended onto any contiguous vacant land under the same ownership if such land was held under the same ownership on October 1, 2001, and has been maintained under the same ownership continuously thereafter. The extension of a continued development onto contiguous vacant land under the same ownership must comply with all applicable standards in the underlying zone.
 - (3) A determination by the Building Official that a continued development is derelict or dangerous, as defined in SRC 50.600 and 56.230, shall terminate the continued development status conferred by this subsection and the building or structure shall thereafter be deemed a nonconforming development.

- (b) *Lot standards.* Lots for townhouses within the Pine Street Mixed-Use Overlay Zone shall conform to standards set forth in Table 604-2.

TABLE 604-2. LOT STANDARDS		
Requirements	Standard	Limitations & Qualifications
Lot Area		
Single family	Min. 1,500 sq. ft.	Applicable to townhouses.
Lot Width		
Single family	Min. 20 ft.	Applicable to townhouses.
Lot Depth		
Single family	Min. 65 ft.	Applicable to townhouses.

- (c) *Dwelling unit density.* Dwelling unit density within the Pine Street Mixed-Use Overlay Zone shall conform to the standards set forth in Table 604-3. Dwelling unit density cannot be varied or adjusted.

TABLE 604-3. DWELLING UNIT DENSITY		
Use or Activity	Standard	Limitations & Qualifications
Single family, two family, <u>three family, four family,</u> and multiple family	Min. 20 dwelling units per acre	
	None	Applicable to mixed-use buildings where floors above the first floor are used entirely for dwelling units.

- (d) *Building area.* The aggregate floor area of a single development shall not exceed 50,000 square feet, unless developed as part of a mixed-use development. The aggregate floor area of a mixed-use development may exceed 50,000 square feet. All new buildings in a mixed-use development shall have a second floor with an area equal to at least 50 percent of the first floor area.
- (e) *Setbacks.* Setbacks within the Pine Street Mixed-Use Overlay Zone shall be provided as set forth in Table 604-4.

TABLE 604-4. SETBACKS		
Requirements	Standards	Limitations & Qualifications
Abutting Street		

Buildings		
Single family, two family, <u>three family, four family,</u> and multiple family	Min. 12 ft., plus 1 foot for each 1 foot of height over 12 ft.	
	Max. 20 ft.	
Accessory Structures		
Accessory to single family, two family, <u>three family, four family,</u> and multiple family	None	Applicable to accessory structures not more than 4 ft. in height.
	Min. 12 ft., plus 1 foot for each 1 foot of height over 12 ft.	Applicable to accessory structures greater than 4 ft. in height.
Interior Front		
Buildings		
Single family, and two family, <u>three family, and four family</u>	Min. 12 ft., plus 1 foot for each 1 foot of height over 12 ft.	
Accessory Structures		
Accessory to single family, and two family, <u>three family, and four family</u>	None	Applicable to accessory structures not more than 4 ft. in height.
	Min. 12 ft., plus 1 foot for each 1 foot of height over 12 ft.	Applicable to accessory structures greater than 4 ft. in height.
Interior Side		
Buildings		
Single family, and two family, <u>three family, and four family</u>	Min. 5 ft.	
	None	Applicable to townhouses.
Accessory Structures		
Accessory to single family, and two family, <u>three family, and four family</u>	None	Applicable to accessory structures having at least 1 wall which is an integral part of a fence.
	Min. 5 ft.	Applicable to all other accessory structures.
Interior Rear		
Buildings		

Single family, and two family, three family, and four family	Min. 14 ft.	Applicable to any portion of a building not more than 1 story in height.
	< Min. 20 ft.	Applicable to any portion of a building greater than 1 story in height.
Accessory Structures		
Accessory to single family, and two family, three family, and four family	None	Applicable to accessory structures not more than 9 ft. in height.
	Min. 1 foot for each 1 foot of height over 9 ft.	Applicable to accessory structures greater than 9 ft. in height.
	Min. 1 ft.	Applicable to accessory structures adjacent to an alley, unless a greater setback is required based on the height of the accessory structure.

- (f) *Landscaping.* Berms, mounds, raised beds, and grade drops shall not be allowed as a landscaping treatment, unless a bioswale treatment system or approved landscaping exists to adequately collect water runoff and the berms, mounds, raised beds, and grade drops do not exceed a 3:1 slope.
- (g) *Off-street parking and loading areas.*
- (1) Planter bays or islands shall have a minimum planting area of 50 square feet.
 - (2) A minimum of one tree per eight parking spaces is required, of which a maximum of 25 percent may be evergreen trees. Trees shall be planted within 20 feet of the parking lot perimeter. Trees within the public street right-of-way shall not count toward the tree planting requirements.
 - (3) Off-street parking may be provided no more than 800 feet from the edge of the lot, or contiguous lots, upon which the main building is located.
 - (4) Employee off-street parking may be provided no more than 2,000 feet from the edge of the lot, or contiguous lots, upon which the main building is located.
 - (5) Parking lot light structures shall not exceed 25 feet in height.
 - (6) The minimum off-street parking requirement for household living uses shall be one space per dwelling unit.
- (h) *Screening.*
- (1) Trash receptacles shall be screened from adjacent household living uses and streets by a sight-obscuring fence, wall, or hedge.
 - (2) Concertina or barbed wire fencing shall not be located within 60 feet of the street right-of-way, unless such fencing is obstructed by a building or structure.
 - (3) Concertina or barbed wire fencing shall be screened from public view and adjacent property by sight-obscuring landscaping.

- (i) *Outdoor storage.*
 - (1) Outdoor storage areas shall not be located within required setbacks.
 - (2) Outdoor storage areas shall be enclosed by a minimum six-foot-high sight-obscuring fence, wall, hedge, or berm; provided, however, items more than six feet in height above grade shall be screened by sight-obscuring landscaping.
 - (3) Items stored within outdoor storage areas shall not exceed a maximum height of 14 feet above grade.
- (j) *Pedestrian access.*
 - (1) A pedestrian connection shall be provided from the public sidewalk to the primary building entrance.
 - (2) A pedestrian connection through the parking area to the primary building entrance shall be provided when the parking area is greater than 60 feet in depth.
 - (3) Within shopping centers, office complexes, and mixed-use developments, pedestrian connections shall be provided to connect the buildings. Pedestrian connections shall be the most practical, direct route.
 - (4) Pedestrian connections shall be a minimum of five feet in width, and defined by visual contrast or tactile finish texture.
 - (5) Wheel stops or extended curbs shall be provided along required pedestrian connections to prevent the encroachment of vehicles onto pedestrian connections.
- (k) *Project enhancements.* Development within the Pine Street Mixed-Use Overlay Zone shall include four or more of the following project enhancements:
 - (1) Closure of one driveway approach on Portland/Fairgrounds Road;
 - (2) Joint parking agreement under SRC 806.020(a)(5), or implementation of a plan to satisfy off-street parking requirements through alternative modes of transportation under SRC 806.015(e)(2);
 - (3) Freestanding sign not more than five feet in height and placed upon a foundation;
 - (4) Weather protection, in the form of awnings or canopies, along more than 75 percent of the length of the ground floor building facade adjacent to sidewalks or pedestrian connections;
 - (5) Cast iron or wrought iron fencing adjacent to Portland/Fairgrounds Road;
 - (6) Pedestrian connections that are:
 - (A) Constructed with pavers, scored or colored cement, and/or stamped asphalt;
 - (B) Elevated above the parking area and driveway; or
 - (C) Defined with landscaping or building features such as canopies, awnings, or arcades;
 - (7) Development on surface parking lots existing on October 1, 2001;
 - (8) Provision of one or more of the following pedestrian-oriented design features on private property adjacent to Portland/Fairgrounds Road:

- (A) Pedestrian scale lighting not more than 16 feet in height; or
- (B) Plazas or other outdoor spaces open to the public;
- (9) A minimum of seven percent interior landscaping within parking areas not more than 50,000 square feet in size; or a minimum of ten percent interior landscaping within parking areas greater than 50,000 square feet in size;
- (10) Installation of landscaping and irrigation using a plan designed by an Oregon landscape architect; or
- (11) Development of a mixed-use building.

Sec. 604.025. - Design review.

Design review under SRC chapter 225 is required for development within the Pine Street Mixed-Use Overlay Zone as follows:

- (a) Except as otherwise provided in this section, design review according to the design review guidelines or the design review standards set forth in SRC 604.030 is required for all development within the Pine Street Mixed-Use Overlay Zone.
- (b) Multiple family development, other than multiple family development within a mixed-use building, shall only be subject to design review according to ~~the multiple family design review guidelines~~ or the multiple family design review standards set forth in SRC chapter 702.
- (c) Multiple family development within a mixed-use building shall only be subject to design review according to the design review guidelines or the design review standards set forth in SRC 604.030.
- (d) Residential care with ~~five~~three or more self-contained dwelling units shall only be subject to design review according to the ~~multiple family design review guidelines~~ or the multiple family design review standards set forth in SRC chapter 702.
- (e) Any development requiring historic design review shall only be subject to design review according to the historic design review standards or the historic design review guidelines set forth in SRC chapter 230.

Sec. 605.015. - Uses.

- (a) *General.* Except as otherwise provided in this section, the uses set forth in Table 605-1 shall be the only permitted (P), special (S), conditional (C), and prohibited (N) uses in the Northgate Mixed Use Overlay Zone.

TABLE 605-1. USES		
Use	Status	Limitations & Qualifications
Household Living		
Single family	P	The following single family activities: <ul style="list-style-type: none"> ■ Townhouse. ■ Residential home, as defined under ORS 197.660.
	N	All other single family.

Two family	C	Duplex, not constructed as part of a mixed-use development.
	N	All other two family.
<u>Three family</u>	<u>P</u>	<u>Three family, constructed as part of a mixed-use development.</u>
	<u>C</u>	<u>All other three family.</u>
<u>Four family</u>	<u>P</u>	<u>Four family, constructed as part of a mixed-use development.</u>
	<u>C</u>	<u>All other four family.</u>
Multiple family	P	Multiple family, constructed as part of a mixed-use development.
	C	All other multiple family.
Group Living		
Room and board	C	Room and board serving 5 or fewer persons.
	N	All other room and board.
Residential care	C	Residential facility, as defined under ORS 197.660.
	N	All other residential care.
Nursing care	P	
Lodging		
Short-term commercial lodging	P	
Long-term commercial lodging	C	Long-term commercial lodging, not constructed as part of a mixed-use development.
	N	All other long-term commercial lodging.
Nonprofit shelters	C	Nonprofit shelters serving 5 or fewer persons.
	N	All other nonprofit shelters.
Retail Sales and Service		
Eating and drinking establishments	P	
Retail sales	N	The following retail sales activities: <ul style="list-style-type: none"> ■ Meat and seafood markets, where live animals are sold or processed. ■ Used merchandise stores, where sales and storage of merchandise and equipment is not conducted entirely within a building.
	P	All other retail sales.

Personal services	P	
Postal services and retail financial services	P	
Business and Professional Services		
Office	P	
Audio/visual media production	P	
Laboratory research and testing	P	
Motor Vehicle, Trailer, and Manufactured Dwelling Sales and Services		
Motor vehicle and manufactured dwelling and trailer sales	C	
Motor vehicle services	C	
Commercial parking	P	
Park-and-ride facilities	P	
Taxicabs and car services	N	
Heavy vehicle and trailer sales	N	
Heavy vehicle and trailer service and storage	N	
Recreation, Entertainment, and Cultural Services and Facilities		
Commercial entertainment—indoor	C	Nightclubs, located within 200 feet of a residential zone.
	P	All other commercial entertainment—indoor.
Commercial entertainment—outdoor	N	The following commercial entertainment—outdoor activities: <ul style="list-style-type: none"> ■ Amusement parks. ■ Drive-in movie theaters. ■ Golf courses. ■ Sporting and recreational camps. ■ Recreational vehicle parks and campsites.
	P	All other commercial entertainment—outdoor.
Major event entertainment	N	
Recreational and cultural community services	P	
Parks and open space	P	

Nonprofit membership assembly	P	
Religious assembly	P	
Health Services		
Medical centers/hospitals	N	
Outpatient medical services and laboratories	P	
Educational Services		
Day care	P	
Basic education	P	
Post-secondary and adult education	P	
Civic Services		
Governmental services	P	
Social services	P	
Governmental maintenance services and construction	N	
Public Safety		
Emergency services	P	
Detention facilities	N	
Military installations	P	
Funeral and Related Services		
Cemeteries	N	
Funeral and cremation services	P	
Construction Contracting, Repair, Maintenance, and Industrial Services		
General repair services	C	
Building and grounds services and construction contracting	C	Carpet and upholstery cleaning establishments.
	N	All other building and grounds services and construction contracting.
Cleaning plants	N	
Industrial services	N	
Wholesale Sales, Storage, and Distribution		

General wholesaling	N	
Heavy wholesaling	N	
Warehousing and distribution	C	Online, mail order, and catalog sales.
	N	All other warehousing and distribution.
Self-service storage	N	
Manufacturing		
General manufacturing	C	The following general manufacturing activities: <ul style="list-style-type: none"> ■ Costume jewelry and precious metals metalsmithing. ■ Sundries and notions. ■ Sign manufacturing.
	N	All other general manufacturing.
Heavy manufacturing	N	
Printing	N	
Transportation Facilities		
Aviation facilities	N	
Passenger ground transportation facilities	P	Transit stop shelters.
	C	All other passenger ground transportation facilities.
Marine facilities	N	
Utilities		
Basic utilities	P	
Wireless communication facilities	Allowed	Wireless communication facilities are allowed, subject to SRC chapter 703.
Drinking water treatment facilities	N	
Power generation facilities	N	
Data center facilities	N	
Fuel dealers	N	
Waste-related facilities	N	
Mining and Natural Resource Extraction		
Petroleum and natural gas production	N	
Surface mining	N	

Farming, Forestry, and Animal Services		
Agriculture	N	
Forestry	N	
Agriculture and forestry services	N	
Keeping of livestock and other animals	N	
Animal services	P	Small animal veterinary services.
	N	All other animal services.
Other Uses		
Home occupations	S	Home occupations are allowed, subject to SRC 700.020.

- (b) *Additional conditional uses.* In addition to the uses set forth in Table 605-1, any permitted, special, or conditional use within the Northgate Mixed-Use Overlay Zone shall be a conditional use within the overlay zone if developed with any of the following:
- (1) Drive-through;
 - (2) Outside storage and parking of professional and commercial equipment; or
 - (3) Loading of commercial vehicles over 20,000 pounds of gross vehicle weight.
- (c) *Continued uses.* Uses existing within the Northgate Mixed-Use Overlay Zone that were allowed as permitted, special, or conditional uses on October 1, 2001, but which would otherwise be made nonconforming uses by this chapter, are hereby deemed continued uses. The owner shall have the burden to demonstrate continued use status under this subsection.
- (1) A continued use may be intensified, and buildings or structures housing a continued use may be enlarged, rebuilt, or the exterior altered, provided such intensification, enlargement, rebuilding, or exterior alteration complies with all applicable standards in the underlying zone.
 - (2) A continued use may be extended onto any contiguous vacant land under the same ownership if such land was held under the same ownership on October 1, 2001, and has been maintained under the same ownership continuously thereafter. The extension of a continued use onto contiguous vacant lots under the same ownership must comply with all applicable standards in the underlying zone.
 - (3) A continued use may be changed to any use that is allowed in the Northgate Mixed Overlay Zone. Such change of use shall terminate the continued use status conferred by this subsection and the property must thereafter only be used for uses allowed in the Northgate Mixed-Use Overlay Zone.
 - (4) A determination by the Building Official that the building or structure housing a continued use is derelict or dangerous, as defined in SRC 50.600 and 56.230, shall

terminate the continued use status conferred by this subsection and the property may thereafter only be used for uses allowed in the Northgate Mixed-Use Overlay Zone.

Sec. 605.020. - Development standards.

Development within the Northgate Mixed-Use Overlay Zone must comply with the development standards applicable in the underlying zone and the development standards set forth in this section. The development standards in this section are in addition to, and not in lieu of, all other applicable development standards in the underlying zone. Where the development standards in this section conflict with the development standards applicable in the underlying zone, the development standards in this section shall be the applicable development standard.

- (a) *Continued development.* Buildings and structures existing within the Northgate Mixed-Use Overlay Zone that conformed to the development standards existing on October 1, 2001, but which would otherwise be made nonconforming development by this chapter, are hereby deemed continued development. The owner shall have the burden to demonstrate continued development status under this subsection.
 - (1) Continued development may be enlarged, rebuilt, or the exterior altered, provided such enlargement, rebuilding, or exterior alteration complies with all applicable standards in the underlying zone.
 - (2) Continued development may be extended onto any contiguous vacant land under the same ownership if such land was held under the same ownership on October 1, 2001, and has been maintained under the same ownership continuously thereafter. The extension of a continued development onto contiguous vacant land under the same ownership must comply with all applicable standards in the underlying zone.
 - (3) A determination by the Building Official that a continued development is derelict or dangerous, as defined in SRC 50.600 and 56.230, shall terminate the continued development status conferred by this subsection and the building or structure shall thereafter be deemed a nonconforming development.
- (b) *Lot standards.* Lots for townhouses within the Northgate Mixed-Use Overlay Zone shall conform to the standards set forth in Table 605-2.

TABLE 605-2. LOT STANDARDS		
Requirements	Standard	Limitations & Qualifications
Lot Area		
Single family	Min. 1,500 sq. ft.	Applicable to townhouses.
Lot Width		
Single family	Min. 20 ft.	Applicable to townhouses.
Lot Depth		

Single family	Min. 65 ft.	Applicable to townhouses.
---------------	-------------	---------------------------

- (c) *Development density.* Development within the Northgate Mixed-Use Overlay Zone shall conform to the density standards set forth in Table 605-3. Dwelling unit density cannot be varied or adjusted.

TABLE 605-3. DEVELOPMENT DENSITY		
Requirements	Standard	Limitations & Qualifications
Single family, two family, <u>three family, four family,</u> and multiple family	Min. 20 dwelling units per acre	
	None	Applicable to mixed-use buildings where floors above the first floor are used entirely for dwelling units.
All other uses	Min. 0.5 FAR	

- (d) *Building area.* The aggregate floor area of a single development shall not exceed 50,000 square feet, unless developed as part of a mixed-use development. The aggregate floor area of a mixed-use development may exceed 50,000 square feet. All new buildings in a mixed-use development shall have a second level floor area equal to at least 50 percent of the first floor area.
- (e) *Setbacks.* Setbacks within the Northgate Mixed-Use Overlay Zone shall be provided as set forth in Table 605-4.

TABLE 605-4. SETBACKS		
Requirements	Standards	Limitations & Qualifications
Abutting Street		
Buildings		
Single family, two family, <u>three family, four family,</u> and multiple family	Min. 12 ft., plus 1 foot for each 1 foot of height over 12 ft.	
	Max. 20 ft.	
Accessory Structures		
Accessory to single family, two family, <u>three family, four family,</u> and multiple family	None	Applicable to accessory structures not more than 4 ft. in height.
	Min. 12 ft., plus 1 foot for each 1 foot of height over 12 ft.	Applicable to accessory structures greater than 4 ft. in height.

Interior Front		
Buildings		
Single family, and two family, <u>three family, and four family</u>	Min. 12 ft., plus 1 foot for each 1 foot of height over 12 ft.	
Accessory Structures		
Accessory to single family, and two family, three family, <u>and four family</u>	None	Applicable to accessory structures not more than 4 ft. in height.
	Min. 12 ft., plus 1 foot for each 1 foot of height over 12 ft.	Applicable to accessory structures greater than 4 ft. in height.
Interior Side		
Buildings		
Single family, and two family, <u>three family, and four family</u>	Min. 5 ft.	
	None	Applicable to townhouses.
Accessory Structures		
Accessory to single family, and two family, three family, <u>and four family</u>	None	Applicable to accessory structures having at least 1 wall which is an integral part of a fence.
	Min. 5 ft.	Applicable to all other accessory structures.
Interior Rear		
Buildings		
Single family, and two family, <u>three family, and four family</u>	Min. 14 ft.	Applicable to any portion of a building not more than 1 story in height.
	Min. 20 ft.	Applicable to any portion of a building greater than 1 story in height.
Accessory Structures		
Accessory to single family, and two family, three family, <u>and four family</u>	None	Applicable to accessory structures not more than 9 ft. in height.
	Min. 1 foot for each 1 foot of height over 9 ft.	Applicable to accessory structures greater than 9 ft. in height.
	Min. 1 ft.	Applicable to accessory structures adjacent to an alley, unless a greater

		setback is required based on the height of the accessory structure.
--	--	---

- (f) *Landscaping.* Berms, mounds, raised beds, and grade drops shall not be allowed as a landscaping treatment, unless a bioswale treatment system or approved landscaping exists to adequately collect water runoff and the berms, mounds, raised beds, and grade drops do not exceed a 3:1 slope.
- (g) *Off-street parking and loading areas.*
- (1) Planter bays or islands shall have a minimum planting area of 50 square feet.
 - (2) A minimum of one tree per eight parking spaces is required, of which a maximum of 25 percent may be evergreen trees. Trees shall be planted within 20 feet of the parking lot perimeter. Trees within the public street right-of-way shall not count toward the tree planting requirements.
 - (3) Off-street parking may be provided no more than 800 feet from the edge of the lot, or contiguous lots, upon which the main building is located.
 - (4) Employee off-street parking may be provided no more than 2,000 feet from the edge of the lot, or contiguous lots, upon which the main building is located.
 - (5) Parking lot light structures shall not exceed 25 feet in height.
 - (6) The minimum off-street parking requirement for household living uses shall be one space per dwelling unit.
- (h) *Screening.*
- (1) Trash receptacles shall be screened from adjacent household living uses and streets by a sight-obscuring fence, wall, or hedge.
 - (2) Concertina or barbed wire fencing shall not be located within 60 feet of the street right-of-way, unless such fencing is obstructed by a building or structure.
 - (3) Concertina or barbed wire fencing shall be screened from public view and adjacent property by sight-obscuring landscaping.
- (i) *Outdoor storage.*
- (1) Outdoor storage areas shall not be located within required setbacks.
 - (2) Outdoor storage areas shall be enclosed by a minimum six-foot-high sight-obscuring fence, wall, hedge, or berm; provided, however, items more than six feet in height above grade shall be screened by sight-obscuring landscaping.
 - (3) Items stored within outdoor storage areas shall not exceed a maximum height of 14 feet above grade.
- (j) *Pedestrian access.*
- (1) A pedestrian connection shall be provided from the public sidewalk to the primary building entrance.
 - (2) A pedestrian connection through the parking area to the primary building entrance shall be provided when the parking area is greater than 60 feet in depth.

- (3) Within shopping centers, office complexes, and mixed-use developments, pedestrian connections shall be provided to connect the buildings. Pedestrian connections shall be the most practical, direct route.
 - (4) Pedestrian connections shall be a minimum of five feet in width, and defined by visual contrast or tactile finish texture.
 - (5) Wheel stops or extended curbs shall be provided along required pedestrian connections to prevent the encroachment of vehicles onto pedestrian connections.
- (k) *Project enhancements.* Development within the Northgate Mixed-Use Overlay Zone shall include four or more of the following project enhancements:
- (1) Closure of one driveway approach on Portland/Fairgrounds Road;
 - (2) Joint parking agreement under SRC 806.020(a)(5), or implementation of a plan to satisfy off-street parking requirements through alternative modes of transportation under SRC 806.015(e)(2);
 - (3) Freestanding sign not more than five feet in height and placed upon a foundation;
 - (4) Weather protection, in the form of awnings or canopies, along more than 75 percent of the length of the ground floor building facade adjacent to sidewalks or pedestrian connections;
 - (5) Cast iron or wrought iron fencing adjacent to Portland/Fairgrounds Road;
 - (6) Pedestrian connections that are:
 - (A) Constructed with pavers, scored or colored cement, and/or stamped asphalt;
 - (B) Elevated above the parking area and driveway; or
 - (C) Defined with landscaping or building features such as canopies, awnings, or arcades;
 - (7) Development on surface parking lots existing on October 1, 2001;
 - (8) Provision of one or more of the following pedestrian-oriented design features on private property adjacent to Portland/Fairgrounds Road:
 - (A) Pedestrian scale lighting not more than 16 feet in height; or
 - (B) Plazas or other outdoor spaces open to the public;
 - (9) A minimum of seven percent interior landscaping within parking areas not more than 50,000 square feet in size; or a minimum of ten percent interior landscaping within parking areas greater than 50,000 square feet in size;
 - (10) Installation of landscaping and irrigation using a plan designed by an Oregon landscape architect; or
 - (11) Development of a mixed-use building.

Sec. 605.025. - Design review.

Design review under SRC chapter 225 is required for development within the Northgate Mixed Use Overlay Zone as follows:

- (a) Except as otherwise provided in this section, design review according to the design review guidelines or the design review standards set forth in SRC 605.030 is required for all development within the Northgate Mixed-Use Overlay Zone.
- (b) Multiple family development, other than multiple family development within a mixed-use building, shall only be subject to design review according to ~~the multiple family design review guidelines~~ or the multiple family design review standards set forth in SRC chapter 702.
- (c) Multiple family development within a mixed-use building shall only be subject to design review according to the design review guidelines or the design review standards set forth in SRC 605.030.
- (d) Residential care with ~~five~~three or more self-contained dwelling units shall only be subject to design review according to ~~the multiple family design review guidelines~~ or the multiple family design review standards set forth in SRC chapter 702.
- (e) Any development requiring historic design review shall only be subject to design review according to the historic design review standards or the historic design review guidelines set forth in SRC chapter 230.

Sec. 606.025. - Design review.

Design review under SRC chapter 225 is required for development within the Wallace Road Corridor Overlay Zone as follows:

- (a) Except as otherwise provided in this section, design review according to the design review guidelines or the design review standards set forth in SRC 606.030 is required for all development within the Wallace Road Corridor Overlay Zone.
- (b) Multiple family development, other than multiple family development within a mixed-use building, shall only be subject to design review according to ~~the multiple family design review guidelines~~ or the multiple family design review standards set forth in SRC chapter 702.
- (c) Multiple family development within a mixed-use building shall only be subject to design review according to the design review guidelines or the design review standards set forth in SRC 606.030.
- (d) Any development requiring historic design review shall only be subject to design review according to the historic design review standards or the historic design review guidelines set forth in SRC chapter 230.

Sec. 609.020. - Development standards.

Development within the Patterson Street Corridor Overlay Zone must comply with the development standards applicable in the underlying zone and the development standards set forth in this section. The development standards in this section are in addition to, and not in lieu of, all other applicable development standards in the underlying zone. Where the development standards in this section conflict with the development standards applicable in the underlying zone, the development standards in this section shall be the applicable development standard.

- (a) *Continued development.* Buildings and structures existing within the Patterson Street Corridor Overlay Zone that conformed to the development standards existing on

December 1, 2002, but which would otherwise be made nonconforming development by this chapter, are hereby deemed continued development. The owner shall have the burden to demonstrate continued development status under this subsection.

- (1) Continued development may be enlarged, rebuilt, or the exterior altered, provided such enlargement, rebuilding, or exterior alteration complies with all applicable standards in the underlying zone.
 - (2) An owner or user of property on December 1, 2002, may extend continued development onto any contiguous vacant land owned by such owner or user if such land was held under the same ownership on December 1, 2002, and has been maintained under the same ownership continuously thereafter. The extension of continued development onto contiguous vacant land under the same ownership must comply with all applicable standards in the underlying zone.
 - (3) A determination by the Building Official that a continued development is derelict or dangerous, as defined in SRC 50.600 and 56.230, shall terminate the continued development status conferred by this subsection and the building or structure shall thereafter be deemed a nonconforming development.
- (b) *Pedestrian access.* All development, other than development of single family and two family uses, shall comply with the following pedestrian access standards:
- (1) A pedestrian connection shall be provided from the public sidewalk to the primary building entrance.
 - (2) A pedestrian connection through the parking area to the primary building entrance shall be provided when the parking area is greater than 60 feet in depth.
 - (3) Within shopping centers, office complexes, and mixed-use developments, pedestrian connections shall be provided to connect the buildings. Pedestrian connections shall be the most practical, direct route.
 - (4) Pedestrian connections shall be a minimum of five feet in width, and defined by visual contrast or tactile finish texture.
 - (5) Wheel stops or extended curbs shall be provided along required pedestrian connections to prevent the encroachment of vehicles onto pedestrian connections.
- (c) *Project enhancements.* All development, other than development of single family and two family uses, shall include four or more of the following project enhancements:
- (1) Joint parking agreement under SRC 806.020(a)(5) or implementation of a plan to satisfy off-street parking requirements through alternative modes of transportation under SRC 806.015(e)(2);
 - (2) Freestanding sign not more than five feet in height and placed upon a foundation;
 - (3) Weather protection, in the form of awnings or canopies, along more than 50 percent of the length of the ground floor building facade adjacent to sidewalks or pedestrian connections;
 - (4) Pedestrian connections that are:
 - (A) Constructed with pavers, scored or colored cement, and/or stamped asphalt;
 - (B) Elevated above the parking area and driveway; or

- (C) Defined with landscaping or building features such as canopies, awnings, or arcades;
- (5) Replacement of existing surface parking areas with new development of buildings or structures;
- (6) A minimum of seven percent interior landscaping within parking areas not more than 50,000 square feet in size; or a minimum of ten percent interior landscaping within parking areas greater than 50,000 square feet in size;
- (7) Installation of landscaping and irrigation using a plan designed by an Oregon landscape architect;
- (8) Development of a mixed-use building;
- (9) Construction of a building where at least 50 percent of the building frontage is constructed contiguous to the minimum building setback line;
- (10) Construction of one or more buildings at least two stories in height;
- (11) Construction of planter bays, each a minimum of 50 square feet in size, to meet minimum interior parking area landscaping requirements;
- (12) Construction of planter bays below the surface grade of parking areas to accommodate surface water runoff; or
- (13) Use of native plant materials to meet minimum landscaping requirements.

Sec. 612.015. - Development standards.

Development within the Walker School Residential Area Overlay Zone must comply with the development standards applicable in the underlying zone and the development standards set forth in this section. The development standards in this section are in addition to, and not in lieu of, all other applicable development standards in the underlying zone. Where the development standards in this section conflict with the development standards applicable in the underlying zone, the development standards in this section shall be the applicable development standard.

- (a) *Continued development.* Buildings and structures existing within the Walker School Residential Area Overlay Zone that conformed to the development standards existing on December 1, 2002, but which would otherwise be made nonconforming development by this chapter, are hereby deemed continued development. The owner shall have the burden to demonstrate continued development status under this subsection.
 - (1) Continued development may be enlarged, rebuilt, or the exterior altered, provided such enlargement, rebuilding, or exterior alteration complies with all applicable standards in the underlying zone.
 - (2) An owner or user of property on December 1, 2002, may extend continued development onto any contiguous vacant land owned by such owner or user if such land was held under the same ownership on December 1, 2002, and has been maintained under the same ownership continuously thereafter. The extension of a continued development onto contiguous vacant land under the same ownership must comply with all applicable standards in the underlying zone.

- (3) A determination by the Building Official that a continued development is derelict or dangerous, as defined in SRC 50.600 and 56.230, shall terminate the continued development status conferred by this subsection and the building or structure shall thereafter be deemed a nonconforming development.
- (b) *Pedestrian access.* All development, other than development of single family, ~~and two family,~~ three family, and four family uses, shall comply with the following pedestrian access standards:
- (1) A pedestrian connection shall be provided from the public sidewalk to the primary building entrance.
 - (2) A pedestrian connection through the parking area to the primary building entrance shall be provided when the parking area is greater than 60 feet in depth.
 - (3) Within shopping centers, office complexes, and mixed-use developments pedestrian connections shall be provided to connect the buildings. Pedestrian connections shall be the most practical, direct route.
 - (4) Pedestrian connections shall be a minimum of five feet in width and defined by visual contrast or tactile finish texture.
 - (5) Wheel stops or extended curbs shall be provided along required pedestrian connections to prevent the encroachment of vehicles onto pedestrian connections.
- (c) *Project enhancements.* All development, other than development of single family, ~~and two family,~~ three family, and four family uses, shall include four or more of the following project enhancements:
- (1) Joint parking agreement under SRC 806.020(a)(5) or implementation of a plan to satisfy off-street parking requirements through alternate modes of transportation under SRC 806.015(e)(2);
 - (2) Freestanding sign not more than five feet in height and placed upon a foundation;
 - (3) Weather protection, in the form of awnings or canopies, along more than 50 percent of the length of the ground floor building facade adjacent to sidewalks and pedestrian connections;
 - (4) Pedestrian connections that are:
 - (A) Constructed with pavers, scored or colored cement, and/or stamped asphalt;
 - (B) Elevated above the parking area and driveway; or
 - (C) Defined with landscaping or building features such as canopies, awnings, or arcades;
 - (5) Replacement of existing surface parking areas with new development of buildings or structures;
 - (6) A minimum of seven percent interior landscaping within parking areas not more than 50,000 square feet in size; or a minimum of ten percent interior landscaping within parking areas greater than 50,000 square feet in size;
 - (7) Installation of landscaping and irrigation using a plan designed by an Oregon landscape architect;

- (8) Construction of a building where at least 50 percent of the building frontage is constructed contiguous to the minimum building setback line;
- (9) Construction of one or more buildings at least two stories in height;
- (10) Construction of planter bays, each a minimum of 50 square feet in size, to meet minimum interior parking area landscaping requirements;
- (11) Construction of planter bays below the surface grade of parking areas to accommodate surface water runoff; or
- (12) Use of native plant materials to meet minimum landscaping requirements.

Sec. 612.020. - Design review.

Design review under SRC chapter 225 is required for development within the Walker School Residential Area Overlay Zone as follows:

- (a) Except as otherwise provided in this section, design review according to the design review guidelines or the design review standards set forth in SRC 612.025 is required for all residential development within the Walker School Residential Area Overlay Zone.
- (b) Design review according to the design review guidelines or the design review standards set forth in SRC 612.025 is not required for: development of single family, two family, three family, or four family uses.
 - (1) ~~Development of single family uses.~~
 - (2) ~~Development of two family uses.~~
- (c) Multiple family development shall be subject to design review according to ~~the multiple family design review guidelines or~~ the multiple family design review standards set forth in SRC chapter 702, and the design review guidelines or the design review standards set forth in SRC 612.025.
- (d) Any development requiring historic design review shall only be subject to design review according to the historic design review standards or the historic design review guidelines set forth in SRC chapter 230.

Sec. 613.015. - Uses.

Except as otherwise provided in this section, any use that is a permitted, special, conditional, or prohibited use in the underlying zone is a permitted, special, conditional, or prohibited use in the Broadway/High Street Retail Overlay Zone.

- (a) *Additional permitted uses.* The uses set forth in Table 613-1 are additional permitted (P) uses in the Broadway/High Street Retail Overlay Zone.

TABLE 613-1. ADDITIONAL PERMITTED USES		
Use	Status	Limitations & Qualifications
Household Living		
<u>Three family</u>	<u>P</u>	
<u>Four family</u>	<u>P</u>	

Multiple family	P	
Motor Vehicle, Trailer, and Manufactured Dwelling Sales and Service		
Commercial parking	P	Only the following commercial parking activities are allowed as additional permitted uses: ■ Parking structures.

- (b) *Additional conditional uses.* The uses set forth in Table 613-2, when allowed in the underlying zone, shall be additional conditional (C) uses in the Broadway/High Street Retail Overlay Zone.

TABLE 613-2. ADDITIONAL CONDITIONAL USES		
Use	Status	Limitations & Qualifications
Retail Sales and Service		
Postal services and retail financial services	C	Only the following postal services and retail financial services activities are additional conditional uses: ■ Banks and credit unions developed with a drive-through.

- (c) *Additional prohibited uses.* In addition to the prohibited uses in the underlying zone, any permitted, special, or conditional use, other than banks and credit unions, within the Broadway/High Street Retail Overlay Zone shall be a prohibited use within the overlay zone if developed with the following:
- (1) Drive-through.

Sec. 613.025. - Design review.

Design review under SRC chapter 225 is required for development within the Broadway/High Street Retail Overlay Zone as follows:

- (a) Except as otherwise provided in this section, design review according to the design review guidelines or the design review standards set forth in SRC 613.030 is required for all development within the Broadway/High Street Retail Overlay Zone.
- (b) Multiple family developments shall only be subject to design review according to the design review guidelines or the design review standards set forth in SRC 613.030.
- (c) Any development requiring historic design review shall only be subject to design review according to the historic design review standards or the historic design review guidelines set forth in SRC chapter 230.

Sec. 614.015. - Uses.

Except as otherwise provided in this section, any use that is a permitted, special, conditional, or prohibited use in the underlying zone is a permitted, special, conditional, or prohibited use in the Broadway/High Street Housing Overlay Zone.

- (a) *Additional permitted uses.* The uses set forth in Table 614-1 are additional permitted (P) uses in the Broadway/High Street Housing Overlay Zone.

TABLE 614-1. ADDITIONAL PERMITTED USES

Use	Status	Limitations & Qualifications
Household Living		
Three family	P	
Four family	P	
Multiple family	P	
Motor Vehicle, Trailer, and Manufactured Dwelling Sales and Service		
Commercial parking	P	Only the following commercial parking activities are allowed as additional permitted uses: <ul style="list-style-type: none"> ■ Parking structures.

- (b) *Uses within mixed-use project with 25 or more dwelling units.* Notwithstanding the permitted, special, conditional, or prohibited uses in the underlying zone, the only uses that shall be permitted (P) in a mixed use project with 25 or more dwelling units within the Broadway/High Street Housing Overlay Zone are the uses set forth in Table 614-2.

TABLE 614-2. USES WITHIN MIXED-USE PROJECT WITH 25 OR MORE DWELLING UNITS

Use	Status	Limitations & Qualifications
Household Living		
Multiple family	P	Multiple family is permitted, subject to SRC 614.015(b)(1).
Lodging		
Short-term commercial lodging	P	Short-term commercial lodging is permitted, subject to SRC 614.015(b)(1).
Long-term commercial lodging	P	Long-term commercial lodging is permitted, subject to SRC 614.015(b)(1).
Retail Sales and Service		
Eating and drinking establishments	P	Eating and drinking establishments are permitted, subject to SRC 614.015(b)(1).
Retail sales	P	Retail sales are permitted, unless noted below, subject to SRC 614.015(b)(1).
Personal services	P	Personal services are permitted, subject to SRC 614.015(b)(1).

Postal and retail financial services	P	Postal and retail financial services are permitted, subject to SRC 614.015(b)(1).
Business and Professional Services		
Office	P	Office is permitted, subject to SRC 614.015(b)(1).
Audio/visual media production	P	Audio/visual media production is permitted, subject to SRC 614.015(b)(1).
Recreation, Entertainment, and Cultural Services and Facilities		
Commercial entertainment—indoor	P	Commercial entertainment—indoor is permitted, subject to SRC 614.015(b)(1).
Recreational and cultural community services	P	Recreational and cultural community services are permitted, subject to SRC 614.015(b)(1).
Health Services		
Outpatient medical services and laboratories	P	Outpatient medical services and laboratories are permitted, subject to SRC 614.015(b)(1).

(1) Limitations on uses in a mixed-use project with 25 or more dwelling units. Uses in a mixed-use project with 25 or more dwelling units set forth in Table 614-2 shall conform to the following additional limitations:

(A) A mix of residential and nonresidential uses shall be provided.

(B) The use shall not include:

(i) Rendering, processing, or cleaning of animals, fish, seafood, fowl, poultry, fruits, vegetables, or dairy products, except for consumption on the premises.

(ii) Packaging of products for retail sale, except for purchases made by a retail customer at the time of purchase.

(iii) Outdoor display or storage of merchandise or materials.

(c) *Additional prohibited uses.* In addition to the prohibited uses in the underlying zone, any permitted, special, or conditional use within the Broadway/High Street Housing Overlay Zone shall be a prohibited use within the overlay zone if developed with the following:

(1) Drive-through.

Sec. 614.020. - Development standards.

Development within the Broadway/High Street Housing Overlay Zone must comply with the development standards applicable in the underlying zone and the development standards set forth in this section. The development standards in this section are in addition to, and not in lieu of, all other applicable development standards in the underlying zone. Where the development standards in this section conflict with the development standards applicable in the

underlying zone, the development standards in this section shall be the applicable development standard.

- (a) *Dwelling units required.* A minimum of 50 percent of the floor area of each new building shall include dwelling units.
- (b) *Location of nonresidential uses within building.* All nonresidential uses, except for office uses, shall be limited to the ground floor of a building. Office uses may be located on the upper floors of a building.
- (c) *Height.* Buildings and accessory structures within the Broadway/High Street Housing Overlay Zone shall conform to the height standards set forth in Table 614-3.

TABLE 614-3. HEIGHT		
Requirements	Standards	Limitations & Qualifications
Height		
Buildings		
All uses	Max. 50 ft.	
Accessory Structures		
Accessory to all uses	Max. 50 ft.	

- (d) *Additional development standards for uses in mixed-use project with 25 or more dwelling units.* Uses in a mixed-use project with 25 or more dwelling units set forth in Table 614-2 shall conform to the following additional development standards:
 - (1) A minimum of 50 percent of the floor area of each building within a mixed-use project shall include dwelling units; except that eating and drinking establishments may be housed in a separate building if the floor area of all nonresidential uses within the mixed-use project, including the eating and drinking establishments, total no more than 50 percent of the total floor area of the mixed-use project.
 - (2) All nonresidential uses, except for office uses, shall be limited to the ground floor of a building or buildings within a mixed-use project. Office uses may be located on upper floors.
- (e) *Reductions to required off-street parking.* Within the Broadway/High Street Retail/Housing Overlay Zone, the minimum number of off-street parking spaces required under SRC chapter 806 shall be automatically reduced by ten percent. Further reductions to the minimum number of required off-street parking spaces may be satisfied through one or more of the following alternative means; provided, however, the total number of off-street parking spaces reduced through such alternative means shall not exceed 20 percent:
 - (1) *Transit stop.* A transit stop or stops approved by the Salem-Keizer Transit District may be used to satisfy five percent of the minimum number of required off-street parking spaces for building sites located within 400 feet of the transit stop or stops.

- (2) *Covered bicycle parking.* Covered bicycle parking, provided at a ratio of one bicycle space for each ten vehicle parking spaces, may be used to satisfy five percent of the minimum number of required off-street parking spaces.
- (3) *Pedestrian improvements.* Pedestrian improvements, provided in an amount equal to or greater than one percent of the estimated construction cost of the proposed building(s), may be used to satisfy ten percent of the minimum number of required off-street parking spaces. Construction cost estimates shall be prepared by a licensed architect, landscape architect, or other qualified professional and shall be subject to review and approval by the Planning Administrator.
 - (A) Pedestrian improvements include plazas, sidewalk extensions on development sites (e.g., sidewalk extensions with outdoor cafe space), street furnishings (e.g., benches, public art, pedestrian-scale lighting, water fountains, trash receptacles, transit shelters, or shade structures), wayfinding signs, or similar amenities, as approved by the Planning Administrator.
 - (B) Where a plaza adjoins a building entrance, pedestrian improvements include the incorporation of weather protection over that plaza in the form of a canopy, awning, pergola, or similar feature.

Sec. 614.025. - Design review.

Design review under SRC chapter 225 is required for development within the Broadway/High Street Housing Overlay Zone as follows:

- (a) Except as otherwise provided in this section, design review according to the design review guidelines or the design review standards set forth in SRC 614.030 is required for all development within the Broadway/High Street Housing Overlay Zone.
- (b) Multiple family development shall only be subject to design review according to the design review guidelines or the design review standards set forth in SRC 614.030.
- (c) Any development requiring historic design review shall only be subject to design review according to the historic design review standards or the historic design review guidelines set forth in SRC chapter 230.

Sec. 615.015. - Uses.

Except as otherwise provided in this section, any use that is a permitted, special, conditional, or prohibited use in the underlying zone is a permitted, special, conditional, or prohibited use in the Broadway/High Street Transition Overlay Zone.

- (a) *Additional permitted uses.* The uses set forth in Table 615-1 are additional permitted (P) uses in the Broadway/High Street Transition Overlay Zone.

TABLE 615-1. ADDITIONAL PERMITTED USES		
Use	Status	Limitations & Qualifications
Household Living		
<u>Three family</u>	<u>P</u>	
<u>Four family</u>	<u>P</u>	

Multiple family	P	
Motor Vehicle, Trailer, and Manufactured Dwelling Sales and Service		
Commercial parking	P	Only the following commercial parking activities are allowed as additional permitted uses: <ul style="list-style-type: none"> ■ Parking structures.

(b) *Uses permitted only within a mixed-use project with 25 or more dwelling units.* Notwithstanding the permitted, special, conditional, or prohibited uses in the underlying zone, the uses set forth in Table 615-2 are permitted (P) within the Broadway/High Street Transition Overlay Zone only if located within a mixed use project with 25 or more dwelling units.

TABLE 615-2. USES PERMITTED ONLY WITHIN A MIXED-USE PROJECT WITH 25 OR MORE DWELLING UNITS

Use	Status	Limitations & Qualifications
Lodging		
Short-term commercial lodging	P	Short-term commercial lodging is permitted, subject to SRC 615.015(b)(1).
Long-term commercial lodging	P	Long-term commercial lodging is permitted, subject to SRC 615.015(b)(1).
Retail Sales and Service		
Eating and drinking establishments	P	Eating and drinking establishments are permitted, subject to SRC 615.015(b)(1).
Retail sales	P	Retail sales are permitted, subject to SRC 615.015(b)(1).
Personal services	P	Personal services are permitted, subject to SRC 615.015(b)(1).
Postal and retail financial services	P	Postal and retail financial services are permitted, subject to SRC 615.015(b)(1).
Business and Professional Services		
Office	P	Office is permitted, subject to SRC 615.015(b)(1).
Audio/visual media production	P	Audio/visual media production is permitted, subject to SRC 615.015(b)(1).
Recreation, Entertainment, and Cultural Services and Facilities		
Commercial entertainment—indoor	P	Commercial entertainment—indoor is permitted, subject to SRC 615.015(b)(1).

Recreational and cultural community services	P	Recreational and cultural community services are permitted, subject to SRC 615.015(b)(1).
Health Services		
Outpatient medical services and laboratories	P	Outpatient medical services and laboratories are permitted, subject to SRC 615.015(b)(1).

(1) *Limitations on uses permitted only within a mixed-use project with 25 or more dwelling units.* Uses permitted only within a mixed-use project with 25 or more dwelling units set forth in Table 615-2 shall conform to the following additional limitations:

- (A) A mix of residential and nonresidential uses shall be provided.
- (B) The use shall not include:
 - (i) Rendering, processing, or cleaning of animals, fish, seafood, fowl, poultry, fruits, vegetables, or dairy products, except for consumption on the premises.
 - (ii) Packaging of products for retail sale, except for purchases made by a retail customer at the time of purchase.
 - (iii) Outdoor display or storage of merchandise or materials.

(c) *Uses permitted only within a parking structure.* Notwithstanding the permitted, special, conditional, or prohibited uses in the underlying zone, the uses set forth in Table 615-3 are permitted (P) within the Broadway/High Street Transition Overlay Zone only if located within a parking structure.

TABLE 615-3. USES PERMITTED ONLY WITHIN A PARKING STRUCTURE		
Use	Status	Limitations & Qualifications
Lodging		
Short-term commercial lodging	P	
Long-term commercial lodging	P	
Retail Sales and Service		
Eating and drinking establishments	P	
Retail sales	P	
Personal services	P	
Postal and retail financial services	P	
Business and Professional Services		
Office	P	
Audio/visual media production	P	

Recreation, Entertainment, and Cultural Services and Facilities		
Commercial entertainment—indoor	P	
Recreational and cultural community services	P	
Health Services		
Outpatient medical services and laboratories	P	

(d) *Additional prohibited uses.* In addition to the prohibited uses in the underlying zone, any permitted, special, or conditional use within the Broadway/High Street Transition Overlay Zone shall be a prohibited use within the overlay zone if developed with the following:

- (1) Drive-through.

Sec. 615.020. - Development standards.

Development with the Broadway/High Street Transition Overlay Zone must comply with the development standards applicable in the underlying zone and the development standards set forth in this section. The development standards in this section are in addition to, and not in lieu of, all other applicable development standards in the underlying zone. Where the development standards in this section conflict with the development standards applicable in the underlying zone, the development standards in this section shall be the applicable development standard.

- (a) *Height.* Buildings and accessory structures within the Broadway/High Street Transition Overlay Zone shall conform to the height standards set forth in Table 615-4.

TABLE 615-4. HEIGHT		
Requirements	Standards	Limitations & Qualifications
Height		
Buildings		
All uses	Max. 50 ft.	
Accessory Structures		
Accessory to all uses	Max. 50 ft.	

- (b) *Additional development standards for uses permitted only in a mixed-use project with 25 or more dwelling units.* Uses permitted only in a mixed-use project with 25 or more dwelling units set forth in Table 615-2 shall conform to the following additional development standards:

- (1) A minimum of 50 percent of the floor area of each building within a mixed-use project shall include dwelling units; except that eating and drinking establishments may be housed in a separate building if the floor area of all nonresidential uses

within the mixed-use project, including the eating and drinking establishments, total no more than 50 percent of the total floor area of the mixed-use project.

- (2) All nonresidential uses, except for office uses, shall be limited to the ground floor of a building or buildings within a mixed-use project. Office uses may be located on upper floors.
- (c) *Reductions to required off-street parking.* Within the Broadway/High Street Transition~~Retail~~ Overlay Zone, the minimum number of off-street parking spaces required under SRC chapter 806 shall be automatically reduced by ten percent. Further reductions to the minimum number of required off-street parking spaces may be satisfied through one or more of the following alternative means; provided, however, the total number of off-street parking spaces reduced through such alternative means shall not exceed 20 percent:
 - (1) *Transit stop.* A transit stop or stops approved by the Salem-Keizer Transit District may be used to satisfy five percent of the minimum number of required off-street parking spaces for building sites located within 400 feet of the transit stop or stops.
 - (2) *Covered bicycle parking.* Covered bicycle parking, provided at a ratio of one bicycle space for each ten vehicle parking spaces, may be used to satisfy five percent of the minimum number of required off-street parking spaces.
 - (3) *Pedestrian improvements.* Pedestrian improvements, provided in an amount equal to or greater than one percent of the estimated construction cost of the proposed building(s), may be used to satisfy ten percent of the minimum number of required off-street parking spaces. Construction cost estimates shall be prepared by a licensed architect, landscape architect, or other qualified professional and shall be subject to review and approval by the Planning Administrator.
 - (A) Pedestrian improvements include plazas, sidewalk extensions on development sites (e.g., sidewalk extensions with outdoor cafe space), street furnishings (e.g., benches, public art, pedestrian-scale lighting, water fountains, trash receptacles, transit shelters, or shade structures), wayfinding signs, or similar amenities, as approved by the Planning Administrator.

Sec. 615.025. - Design review.

Design review under SRC chapter 225 is required for development within the Broadway/High Street Transition Overlay Zone as follows:

- (a) Except as otherwise provided in this section, design review according to the design review guidelines or the design review standards set forth in SRC 615.030 is required for all development within the Broadway/High Street Transition Overlay Zone.
- (b) Multiple family development, other than multiple family development within a mixed-use building, shall only be subject to design review according to ~~the multiple family design review guidelines or the multiple family design review standards set forth in SRC chapter 702.~~
- (c) Multiple family development within a mixed-use building shall only be subject to design review according to the design review guidelines or the design review standards set forth in SRC 615.030.

- (d) Any development requiring historic design review shall only be subject to design review according to the historic design review standards or the historic design review guidelines set forth in SRC chapter 230.

Sec. 616.020. - Development standards.

Development within the Riverfront High Density Residential Overlay Zone must comply with the development standards applicable in the underlying zone and the development standards set forth in this section. The development standards in this section are in addition to, and not in lieu of, all other applicable development standards in the underlying zone. Where the development standards in this section conflict with the development standards applicable in the underlying zone, the development standards in this section shall be the applicable development standard.

- (a) *Dwelling unit density.* Dwelling unit density within the Riverfront High Density Residential Overlay Zone shall conform to the standards set forth in Table 616-2.

TABLE 616-2. DWELLING UNIT DENSITY			
Use or Activity	Standard		Limitations & Qualifications
	Minimum	Maximum	
Single family, two family, <u>three family</u> , <u>four family</u> , and multiple family	20 dwelling units per acre	None	

- (b) *Height.* Buildings and accessory structures within the Riverfront High Density Residential Overlay Zone shall conform to the height standards set forth in Table 616-3.

TABLE 616-3. HEIGHT		
Requirements	Standards	Limitations & Qualifications
Height		
Buildings		
All uses	Max. 70 ft.	
Accessory Structures		
Accessory to all uses	Max. 70 ft.	

- (c) *Additional development standards for additional permitted uses in Table 616-1.* With the exception of parking structures, the additional permitted uses set forth in Table 616-1 shall conform to the following additional development standards:
- (1) *Location.* The uses shall be restricted to the ground floor of a building.
 - (2) *Size.* The uses shall not exceed 50 percent of the gross floor area of a project; provided, however, grocery stores and other related food stores shall not contain more than 15,000 square feet of gross floor area per establishment.

Sec. 617.020. - Development standards.

Development with the Riverfront Overlay Zone must comply with the development standards applicable in the underlying zone and the development standards set forth in this section. The development standards in this section are in addition to, and not in lieu of, all other applicable development standards in the underlying zone. Where the development standards in this section conflict with the development standards applicable in the underlying zone, the development standards in this section shall be the applicable development standard.

- (a) *Dwelling unit density.* Dwelling unit density within the Riverfront Overlay Zone shall conform to the standards set forth in Table 617-2.

TABLE 617-3. DWELLING UNIT DENSITY			
Use or Activity	Standard		Limitations & Qualifications
	Minimum	Maximum	
Single family, two family, <u>three family</u> , <u>four family</u> , and multiple family	20 dwelling units per acre	None	

- (b) *Height.* Buildings and accessory structures within the Riverfront Overlay Zone shall conform to the height standards set forth in Table 617-4.

TABLE 617-4. HEIGHT		
Requirements	Standards	Limitations & Qualifications
Height		
Buildings		
All uses	Max. 70 ft.	
Accessory Structures		
Accessory to all uses	Max. 70 ft.	

Sec. 619.015. - Uses.

Except as otherwise provided in this section, any use that is a permitted, special, conditional, or prohibited use in the underlying zone is a permitted, special, conditional, or prohibited use in the Mixed-Use Overlay Zone.

- (a) *Additional permitted uses.* The uses set forth in Table 619-1 are additional permitted (P) uses in the Mixed-Use Overlay Zone.

TABLE 619-1. ADDITIONAL PERMITTED USES

Use	Status	Limitations & Qualifications
Household Living		
Single family	P	Only the following single family activities are allowed as additional permitted uses: <ul style="list-style-type: none"> ■ Townhouse. ■ Residential home, as defined under ORS 197.660.
Two family	P	Only the following two family activities are allowed as additional permitted uses: <ul style="list-style-type: none"> ■ Duplex.
<u>Three family</u>	<u>P</u>	
<u>Four family</u>	<u>P</u>	
Multiple family	P	
Group Living		
Room and board	P	Only the following room and board activities are allowed as additional permitted uses: <ul style="list-style-type: none"> ■ Room and board serving 5 or fewer persons.
Recreation, Entertainment, and Cultural Services and Facilities		
Recreation and cultural Community services	P	
Parks and open space	P	
Public Safety		
Emergency services	P	Only the following emergency services activities are allowed as additional permitted uses: <ul style="list-style-type: none"> ■ Fire stations.

Sec. 619.020. - Development standards.

Development within the Mixed-Use Overlay Zone must comply with the development standards applicable in the underlying zone and the development standards set forth in this section. The development standards in this section are in addition to, and not in lieu of, all other applicable development standards in the underlying zone. Where the development standards in this section conflict with the development standards applicable in the underlying zone, the development standards in this section shall be the applicable development standard.

- (a) *Dwelling Unit Density.* Dwelling unit density within the Mixed-Use Overlay Zone shall conform to the standards set forth in Table 619-2.

TABLE 619-2. DWELLING UNIT DENSITY		
Use or Activity	Standard	Limitations & Qualifications

Single family, two family, <u>three family, four family,</u> and multiple family	Min. 12 dwelling units per acre	
	None	Applicable to mixed-use buildings.

- (b) *Height.* Buildings and accessory structures within the Mixed-Use Overlay Zone shall conform to the height standards set forth in Table 619-3.

TABLE 619-3. HEIGHT		
Requirements	Standards	Limitations & Qualifications
Height		
Buildings and Accessory Structures		
All uses	Max. 75 ft.	Applicable when developed as part of a mixed-use development.
Accessory Structures		
Accessory to all uses	Max. 75 ft.	Applicable when developed as part of a mixed-use development.

- (c) *Off-street parking.* Off-street parking for dwelling units within the Mixed-Use Overlay Zone shall be as follows:
- (1) *Minimum off-street parking.* The minimum off-street parking requirement for dwelling units within the Mixed-Use Overlay Zone shall be one space per dwelling unit.
 - (2) *Maximum off-street parking.* The maximum off-street parking requirement for dwelling units within the Mixed-use Overlay Zone shall be 2.5 spaces per dwelling unit.

Sec. 619.025. - Design review.

Design review under SRC chapter 225 is required for development within the Mixed-Use Overlay Zone as follows:

- (a) Multiple family development, other than multiple family development within a mixed-use building, shall be subject to design review according to ~~the multiple family design review guidelines or the multiple family design review standards set forth in SRC chapter 702.~~
- (b) Multiple family development within a mixed-use building shall not be subject to design review according to ~~the multiple family design review guidelines or the multiple family design review standards set forth in SRC chapter 702.~~

- (c) Any development requiring historic design review shall only be subject to design review according to the historic design review standards or the historic design review guidelines set forth in SRC chapter 230.

Sec. 621.015. - Development standards.

Change of use or development within the Superior/Rural Overlay Zone must comply with the development standards applicable in the underlying zone and the development standards set forth in this section. The development standards in this section are in addition to, and not in lieu of, all other applicable development standards in the underlying zone. Where the development standards in this section conflict with the development standards applicable in the underlying zone, the development standards in this section shall be the applicable development standard.

- (a) *Setbacks.* Setbacks within the Superior/Rural Overlay Zone shall be provided as set forth in Table 621-1.

TABLE 621-1. SETBACKS		
Requirement	Standard	Limitations & Qualifications
Abutting Street		
Buildings		
Uses other than single family, and two family, three family, and four family	Min. 12 ft., plus 1 ft. for each 1 ft. of height over 12 ft.; provided, however, not more than 20 ft. is required.	
Accessory Structures		
Accessory to uses other than single family, and two family, three family, and four family	Min. 12 ft., plus 1 ft. for each 1 ft. of height over 12 ft.; provided, however, not more than 20 ft. is required.	
Vehicle Use Areas		
Uses other than single family, and two family, three family, and four family	Min. 12 ft.	
Abutting Alley		
Buildings		
Uses other than single family, and two family, three family, and four family	Min. 38 ft.	
Accessory Structures		
Accessory to uses other than single family, and two family, three family, and four family	Min. 38 ft.	

Vehicle Use Areas		
Uses other than single family, and two family, three family, and four family	Min. 10 ft.	

(b) *Height.* Buildings and accessory structures within the Superior/Rural Overlay Zone shall conform to the height standards set forth in Table 621-2.

TABLE 621-2. HEIGHT		
Requirements	Standards	Limitations & Qualifications
Height		
Buildings		
Uses other than single family, and two family, three family, and four family	Max. 35 ft.	
Accessory Structures		
Accessory to uses other than single family, and two family, three family, and four family	Max. 35 ft.	

(c) *Landscaping.* Landscaping shall be provided for uses other than single family, ~~and two family, three family, and four family~~ as set forth in this subsection.

- (1) *Generally.* All areas of the lot not developed shall be landscaped. Landscaping shall meet the requirements set forth in SRC chapter 807.
- (2) *Landscaping abutting alley.*
 - (A) A minimum ten-foot-wide landscape strip shall be provided abutting the alley.
 - (B) Plant materials within the ten-foot-wide landscape strip shall conform to the plant unit (PU) values set forth in Table 621-3, and the number of required plant units set forth in Table 621-4.
 - (C) The required plant units within the ten-foot-wide landscape strip shall be distributed at a density of not less than three plant units per each 20 linear feet of boundary or lot line.
 - (D) Landscaping shall conform to the vision clearance requirements set forth in SRC chapter 805.

TABLE 621-3. PLANT UNIT VALUES

Plant Material	Plant Unit (PU) Value
1 canopy tree	1 PU
1 understory tree	1 PU
1 evergreen/conifer tree	1 PU
1 shrub	1 PU

TABLE 621-4. REQUIRED PLANT UNITS	
Plant Material	Required Plant Units (PU)
Canopy trees	Min. 2 PU per 100 linear feet of boundary or lot line.
Understory trees	Min. 6 PU per 100 linear feet of boundary or lot line.
Evergreen/conifer trees	Min. 6 PU per 100 linear feet of boundary or lot line.
Shrubs	Min. 9 PU per 100 linear feet of boundary or lot line.

- (d) *Screening.* Screening shall be provided for uses other than single family, ~~and two family,~~ three family, and four family as set forth in this subsection.
- (1) *Screening abutting alley.* A four-foot-high sight-obscuring fence, wall, or berm shall be provided abutting the alley. The sight-obscuring fence, wall, or berm shall stop 25 feet from either end of the alley. Screening shall conform to the vision clearance requirements set forth in SRC chapter 805.
 - (2) *Parking and loading areas.* Parking and loading areas shall be screened from adjacent residential uses and from abutting streets by a sight-obscuring fence, wall, or berm. Screening shall conform to the vision clearance requirements set forth in SRC chapter 805.
- (e) *Access.* Access to properties within the Superior/Rural Overlay Zone shall be limited as follows:
- (1) Not more than three permanent driveway approaches may be provided onto Commercial Street SE. The specific locations of the driveway approaches shall be approved by the Director as properties develop.
 - (2) Not more than one permanent driveway approach may be provided onto Superior Street SE, and not more than one permanent driveway approach may be provided onto Rural Street SE. The driveway approaches shall be located no closer than 100 feet west of Commercial Street SE.
 - (3) Driveways serving uses other than single family and two family shall not be allowed onto the alley between Rural Street SE and Superior Street SE.

- (4) If lots are developed individually, temporary access from Commercial Street SE to the individually developed lots may be provided until the permanent driveway approaches allowed under subsections (e)(1) and (2) of this section are developed.
- (5) As development or change of use of property occurs, reciprocal and irrevocable easements for access shall be provided by the appropriate property owners to accommodate joint access from each property to a public street. The easements shall be recorded with the County.
- (f) *Trees.* Trees with a dbh of ten inches or greater shall be preserved wherever possible.
- (g) *Existing buildings.* Existing residential buildings shall be maintained wherever possible and, if converted to nonresidential use, shall maintain their residential character.
- (h) *Location of off-street parking.* Off-street parking serving uses within the overlay zone shall not be located outside of the overlay zone.

Sec. 622.015. - Development standards.

Change of use or development within the Oxford/West Nob Hill Overlay Zone must comply with the development standards applicable in the underlying zone and the development standards set forth in this section. The development standards in this section are in addition to, and not in lieu of, all other applicable development standards in the underlying zone. Where the development standards in this section conflict with the development standards applicable in the underlying zone, the development standards in this section shall be the applicable development standard.

- (a) *Setbacks.* Setbacks within the Oxford/West Nob Hill Overlay Zone shall be provided as set forth in Table 622-1.

TABLE 622-1. SETBACKS		
Requirement	Standard	Limitations & Qualifications
Abutting Street		
Buildings		
Uses other than single family, and two family, <u>three family, and four family</u>	Min. 12 ft., plus 1 ft. for each 1 ft. of height over 12 ft.; provided, however, not more than 20 ft. is required.	Applicable abutting Commercial Street SE, Liberty Street SE, and Oxford Street SE.
	Min. 20 ft.	Applicable abutting West Nob Hill Street SE.
Accessory Structures		
Accessory to uses other than single family, and two family, <u>three family, and four family</u>	Min. 12 ft., plus 1 ft. for each 1 ft. of height over 12 ft.; provided, however,	Applicable abutting Commercial Street SE, Liberty Street SE, and Oxford Street SE.

	not more than 20 ft. is required.	
	Min. 20 ft.	Applicable abutting West Nob Hill Street SE.
Vehicle Use Areas		
Uses other than single family, and two family, three family, and four family	Min. 12 ft.	

(b) *Height.* Buildings and accessory structures within the Oxford/West Nob Hill Overlay Zone shall conform to the height standards set forth in Table 622-2.

TABLE 622-2. HEIGHT		
Requirements	Standards	Limitations & Qualifications
Height		
Buildings		
Uses other than single family, and two family, three family, and four family	Max. 35 ft.	
Accessory Structures		
Accessory to uses other than single family, and two family, three family, and four family	Max. 35 ft.	

(c) *Landscaping.* Landscaping shall be provided for uses other than single family, ~~and two family, three family, and four family~~ as set forth in this subsection.

- (1) *Generally.* All areas of the lot not developed shall be landscaped. Landscaping shall meet the requirements set forth in SRC chapter 807.
- (2) *Landscaping abutting West Nob Hill Street.*
 - (A) A continuous minimum 12-foot-wide landscape strip shall be provided abutting West Nob Hill Street SE. Sidewalks running perpendicular to the street and utility structures may be located within the 12-foot-wide landscape strip.
 - (B) Plant materials within the 12-foot-wide landscape strip shall conform to the plant unit (PU) values set forth in Table 622-3, and the number of required plant units set forth in Table 622-4.
 - (C) The required plant units within the 12-foot-wide landscape strip shall be distributed at a density of not less than three plant units per each 20 linear feet of boundary or lot line.
 - (D) Landscaping shall conform to the vision clearance requirements set forth in SRC chapter 805.

TABLE 622-3. PLANT UNIT VALUES

Plant Material	Plant Unit (PU) Value
1 canopy tree	1 PU
1 understory tree	1 PU
1 evergreen /conifer tree	1 PU
1 shrub	1 PU

TABLE 622-4. REQUIRED PLANT UNITS

Plant Material	Required Plant Units (PU)
Canopy trees	Min. 2 PU per 100 linear feet of boundary or lot line.
Understory trees	Min. 6 PU per 100 linear feet of boundary or lot line.
Evergreen/conifer trees	Min. 6 PU per 100 linear feet of boundary or lot line.
Shrubs	Min. 9 PU per 100 linear feet of boundary or lot line.

(d) *Screening.*

- (1) *Screening abutting West Nob Hill Street.* A four-foot-high sight-obscuring fence, wall, or berm shall be provided abutting West Nob Hill Street SE as follows:
 - (A) The sight-obscuring fence or wall shall be setback 12 feet from West Nob Hill Street.
 - (B) The sight-obscuring berm shall be located within the landscape strip required under subsection (c) of this section.
 - (C) The sight-obscuring fence, wall, or berm shall conform to the vision clearance requirements set forth in SRC chapter 805.
- (2) *Parking and loading areas.* Parking and loading areas shall be screened from adjacent residential uses by a four-foot-high sight-obscuring fence, wall, or hedge. Screening shall conform to the vision clearance requirements set forth in SRC chapter 805.

(e) *Access.* Access to properties within the Oxford/West Nob Hill Overlay Zone shall be limited as follows:

- (1) Not more than one driveway approach may be provided onto West Nob Hill Street SE.
- (2) Not more than one driveway approach may be provided onto Oxford Street SE.
- (3) Driveway approaches shall not be allowed onto Commercial Street SE.

- (f) *Trees.* Trees with a dbh of ten inches or greater shall be preserved wherever possible.
- (g) *Location of off-street parking.* Off-street parking serving uses within the overlay zone shall not be located outside of the overlay zone.

Sec. 623.015. - Development standards.

Change of use or development within the Oxford/Hoyt Overlay Zone must comply with the development standards applicable in the underlying zone and the development standards set forth in this section. The development standards in this section are in addition to, and not in lieu of, all other applicable development standards in the underlying zone. Where the development standards in this section conflict with the development standards applicable in the underlying zone, the development standards in this section shall be the applicable development standard.

- (a) *Orientation.* All activities shall be oriented away from West Nob Hill Street.
- (b) *Hours of operation.* Hours of operation shall be limited to 6:00 a.m. to 12:00 midnight.
- (c) *Setbacks.* Setbacks within the Oxford/Hoyt Overlay Zone shall be provided as set forth in Table 623-1.

TABLE 623-1. SETBACKS		
Requirement	Standard	Limitations & Qualifications
Abutting Street		
Buildings		
Uses other than single family, and two family, <u>three family, and four family</u>	Min. 20 ft.	Applicable abutting West Nob Hill Street SE.
Accessory Structures		
Accessory to uses other than single family, and two family, <u>three family, and four family</u>	Min. 20 ft.	Applicable abutting West Nob Hill Street SE.
Vehicle Use Areas		
Uses other than single family, and two family, <u>three family, and four family</u>	Min. 12 ft.	Applicable abutting West Nob Hill Street SE.

- (d) *Height.* Buildings and accessory structures within the Oxford/Hoyt Overlay Zone shall conform to the height standards set forth in Table 623-2.

TABLE 623-2. HEIGHT		
Requirements	Standards	Limitations & Qualifications
Height		
Buildings		

Uses other than single family, and two family, <u>three family, and four family</u>	Max. 35 ft.	
Accessory Structures		
Accessory to uses other than single family, and two family, <u>three family, and four family</u>	Max. 35 ft.	

- (e) *Landscaping.* Landscaping shall be provided for uses other than single family, ~~and two family,~~ three family, and four family as set forth in this subsection.
- (1) *Generally.* All areas of the lot not developed shall be landscaped. Landscaping shall meet the requirements set forth in SRC chapter 807.
 - (2) *Landscaping abutting West Nob Hill Street.*
 - (A) A continuous minimum 12-foot-wide landscape strip shall be provided abutting West Nob Hill Street SE. Sidewalks running perpendicular to the street and utility structures may be located within the 12-foot-wide landscape strip.
 - (B) Plant materials within the 12-foot-wide landscape strip shall conform to the plant unit (PU) values set forth in Table 623-3, and the number of required plant units set forth in Table 623-4.
 - (C) The required plant units within the 12-foot-wide landscape strip shall be distributed at a density of not less than three plant units per each 20 linear feet of boundary or lot line.
 - (D) Landscaping shall conform to the vision clearance requirements set forth in SRC chapter 805.

TABLE 623-3. PLANT UNIT VALUES	
Plant Material	Plant Unit (PU) Value
1 canopy tree	1 PU
1 understory tree	1 PU
1 evergreen/conifer tree	1 PU
1 shrub	1 PU

TABLE 623-4. REQUIRED PLANT UNITS	
Plant Material	Required Plant Units (PU)
Canopy trees	Min. 2 PU per 100 linear feet of boundary or lot line.
Understory trees	Min. 6 PU per 100 linear feet of boundary or lot line.

Evergreen/conifer trees	Min. 6 PU per 100 linear feet of boundary or lot line.
Shrubs	Min. 9 PU per 100 linear feet of boundary or lot line.

(f) *Screening.*

(1) *Screening abutting West Nob Hill Street.* A four-foot-high sight-obscuring fence, wall, or berm shall be provided abutting West Nob Hill Street SE as follows:

(A) The sight-obscuring fence or wall shall be setback 12 feet from West Nob Hill Street.

(B) The sight-obscuring berm shall be located within the landscape strip required under subsection (e) of this section.

(C) The sight-obscuring fence, wall, or berm shall conform to the vision clearance requirements set forth in SRC chapter 805.

(2) *Parking and loading areas.* Parking and loading areas shall be screened from adjacent residential uses by a sight-obscuring fence, wall, or berm, in combination with living plant material. Screening shall conform to the vision clearance requirements set forth in SRC chapter 805.

(g) *Access.* Access to properties within the Oxford/Hoyt Overlay Zone shall be limited as follows:

(1) Driveways serving uses other than single family and two family shall not be allowed onto West Nob Hill Street SE.

(2) Access to Commercial Street SE shall be limited to the following:

(A) Between Oxford Street SE and Rural Avenue SE. On the block between Oxford Street SE and Rural Avenue SE, access onto Commercial Street SE shall be limited to the two existing driveway approaches.

(B) Between Hoyt Street SE and Fawk Avenue SE. On the block between Hoyt Street SE and Fawk Avenue SE, access to Commercial Street SE shall be limited to one entrance-only driveway approach.

(C) Between Rural Avenue SE and Fawk Avenue SE. On the blocks between Rural Avenue SE and Fawk Avenue SE, no driveway approaches shall be allowed onto Commercial Street SE; provided, however, if lots are developed individually, temporary access from Commercial Street SE to the individually developed lots may be allowed until permanent access to Rural Avenue SE, Jerris Avenue SE, or Fawk Avenue SE is secured. As development or change of use of property occurs, reciprocal and irrevocable easements for access shall be provided by the appropriate property owners to accommodate joint access from each property to Rural Avenue SE, Jerris Avenue SE, or Fawk Avenue SE. The easements shall be recorded with the County.

(h) *Location of off-street parking.* Off-street parking serving uses within the overlay zone shall not be located outside of the overlay zone.

Sec. 624.015. - Development standards.

Change of use or development within the Hoyt/McGilchrist Overlay Zone must comply with the development standards applicable in the underlying zone and the development standards set forth in this section. The development standards in this section are in addition to, and not in lieu of, all other applicable development standards in the underlying zone. Where the development standards in this section conflict with the development standards applicable in the underlying zone, the development standards in this section shall be the applicable development standard.

- (a) *Orientation.* All activities shall be oriented away from West Nob Hill Street.
- (b) *Hours of operation.* Hours of operation shall be limited to 6:00 a.m. to 12:00 midnight.
- (c) *Setbacks.* Setbacks within the Hoyt/McGilchrist Overlay Zone shall be provided as set forth in Table 624-1.

TABLE 624-1. SETBACKS		
Requirement	Standard	Limitations & Qualifications
Abutting Street		
Buildings		
Uses other than single family, and two family, <u>three family, and four family</u>	Min. 20 ft.	Applicable abutting West Nob Hill Street SE.
Accessory Structures		
Accessory to uses other than single family, and two family, <u>three family, and four family</u>	Min. 20 ft.	Applicable abutting West Nob Hill Street SE.
Vehicle Use Areas		
Uses other than single family, and two family, <u>three family, and four family</u>	Min. 12 ft.	Applicable abutting West Nob Hill Street SE.

- (d) *Height.* Buildings and accessory structures within the Hoyt/McGilchrist Overlay Zone shall conform to the height standards set forth in Table 624-2.

TABLE 624-2. HEIGHT		
Requirements	Standards	Limitations & Qualifications
Height		
Buildings		
Uses other than single family, and two family, <u>three family, and four family</u>	Max. 35 ft.	
Accessory Structures		

Accessory to uses other than single family, and two family, three family, and four family	Max. 35 ft.	
--	-------------	--

- (e) *Landscaping.* Landscaping shall be provided for uses other than single family, ~~and two family, three family, and four family~~ as set forth in this subsection.
- (1) *Generally.* All areas of the lot not developed shall be landscaped. Landscaping shall meet the requirements set forth in SRC chapter 807.
- (2) *Landscaping abutting West Nob Hill Street.*
- (A) A continuous minimum 12-foot-wide landscape strip shall be provided abutting West Nob Hill Street SE. Sidewalks running perpendicular to the street and utility structures may be located within the 12-foot-wide landscape strip.
- (B) Plant materials within the 12-foot-wide landscape strip shall conform to the plant unit (PU) values set forth in Table 624-3, and the number of required plant units set forth in Table 624-4.
- (C) The required plant units within the 12-foot-wide landscape strip shall be distributed at a density of not less than three plant units per each 20 linear feet of boundary or lot line.
- (D) Landscaping shall conform to the vision clearance requirements set forth in SRC chapter 805.

TABLE 624-3. PLANT UNIT VALUES	
Plant Material	Plant Unit (PU) Value
1 canopy tree	1 PU
1 understory tree	1 PU
1 evergreen/conifer tree	1 PU
1 shrub	1 PU

TABLE 624-4. REQUIRED PLANT UNITS	
Plant Material	Required Plant Units (PU)
Canopy trees	Min. 2 PU per 100 linear feet of boundary or lot line.
Understory trees	Min. 6 PU per 100 linear feet of boundary or lot line.
Evergreen/conifer trees	Min. 6 PU per 100 linear feet of boundary or lot line.
Shrubs	Min. 9 PU per 100 linear feet of boundary or lot line.

- (f) *Screening.*
- (1) *Screening abutting West Nob Hill Street.* A four-foot-high sight-obscuring fence, wall, or berm shall be provided abutting West Nob Hill Street SE as follows:
 - (A) The sight-obscuring fence or wall shall be setback 12 feet from West Nob Hill Street.
 - (B) The sight-obscuring berm shall be located within the landscape strip required under subsection (e) of this section.
 - (C) The sight-obscuring fence, wall, or berm shall conform to the vision clearance requirements set forth in SRC chapter 805.
 - (2) *Parking and loading areas.* Parking and loading areas shall be screened from adjacent residential uses by a sight-obscuring fence, wall, or berm, in combination with living plant material. Screening shall conform to the vision clearance requirements set forth in SRC chapter 805.
- (g) *Access.* Access to properties within the Hoyt/McGilchrist Overlay Zone shall be limited as follows:
 - (1) All properties with frontage on Commercial Street SE shall be allowed one driveway approach onto Commercial Street SE.
 - (2) No new driveway approaches shall be allowed onto West Nob Hill Street SE.
- (h) *Location of off-street parking.* Off-street parking serving uses within the overlay zone shall not be located outside of the overlay zone.

Sec. 626.015. - Uses.

- (a) *General.* Except as otherwise provided in this section, the uses set forth in Table 626-1 shall be the only permitted (P), special (S), conditional (C), and prohibited (N) uses in the Commercial/High Density Residential Overlay Zone.

TABLE 626-1. USES		
Use	Status	Limitations & Qualifications
Household Living		
Single family	P	Residential home, as defined under ORS 197.660.
	N	All other single family.
Two family	N	
<u>Three family</u>	<u>P</u>	
<u>Four family</u>	<u>P</u>	
Multiple family	P	
Group Living		
Room and board	P	Room and board serving 5 or fewer persons.
	N	All other room and board.

Residential care	P	
Nursing care	S	Nursing care, subject to SRC 700.045.
Lodging		
Short-term commercial lodging	P	
Long-term commercial lodging	P	
Nonprofit shelters	P	
Retail Sales and Service		
Eating and drinking establishments	P	
Retail sales	N	The following retail sales activities: <ul style="list-style-type: none"> ■ Lumber and building materials dealers. ■ Hardware stores. ■ Lawn and garden supply stores. ■ Auto supply stores. ■ Meat and seafood markets, where live animals are sold or processed. ■ Used merchandise stores, where sales and storage of merchandise and equipment is not conducted entirely within a building.
	P	All other retail sales.
Personal services	P	
Postal services and retail financial services	P	
Business and Professional Services		
Office	P	
Audio/visual media production	N	
Laboratory research and testing	N	
Motor Vehicle, Trailer, and Manufactured Dwelling Sales and Services		
Motor vehicle and manufactured dwelling and trailer sales	N	
Motor vehicle services	N	Gas stations.

	C	All other motor vehicle services.
Commercial parking	P	
Park-and-ride facilities	N	
Taxicabs and car services	N	
Heavy vehicle and trailer sales	N	
Heavy vehicle and trailer service and storage	N	
Recreation, Entertainment, and Cultural Services and Facilities		
Commercial entertainment— indoor	C	Nightclubs, located within 200 feet of a residential zone.
	P	All other commercial entertainment—indoor.
Commercial entertainment— outdoor	P	
Major event entertainment	N	
Recreational and cultural community services	P	
Parks and open space	P	
Nonprofit membership assembly	P	
Religious assembly	P	
Health Services		
Medical centers/hospitals	N	
Outpatient medical services and laboratories	P	
Educational Services		
Day care	P	The following day care activities: ■ Child day care home. ■ Adult day care home.
	C	The following day care activities: ■ Child day care center. ■ Adult day care center.
	N	All other day care.

Basic education	P	
Post-secondary and adult education	P	
Civic Services		
Governmental services	P	
Social services	P	
Governmental maintenance services and construction	N	
Public Safety		
Emergency services	P	
Detention facilities	N	
Military installations	P	
Funeral and Related Services		
Cemeteries	N	
Funeral and cremation services	P	
Construction Contracting, Repair, Maintenance, and Industrial Services		
General repair services	P	
Building and grounds services and construction contracting	N	
Cleaning plants	N	
Industrial services	N	
Wholesale Sales, Storage, and Distribution		
General wholesaling	N	<p>The following general wholesaling activities:</p> <ul style="list-style-type: none"> ■ Automobile, and other motor vehicle, and trailer wholesalers. ■ Manufactured dwelling wholesalers. ■ Motor vehicle supplies and parts wholesalers. ■ Non-consumer electronics and electrical supplies wholesalers. ■ Heating and cooling equipment and supplies wholesalers. ■ Industrial and commercial supplies wholesalers. ■ Toys and sporting goods wholesalers. ■ Meat, fish, and poultry product wholesalers.

		<ul style="list-style-type: none"> ■ Farm supplies wholesalers. ■ Paint and varnish wholesalers. ■ Tobacco product wholesalers.
	P	All other general wholesaling.
Heavy wholesaling	N	
Warehousing and distribution	P	
Self-service storage	P	
Manufacturing		
General manufacturing	N	
Heavy manufacturing	N	
Printing	P	
Transportation Facilities		
Aviation facilities	N	
Passenger ground transportation facilities	P	Transit stop shelters.
	N	All other passenger ground transportation facilities.
Marine facilities	N	
Utilities		
Basic utilities	P	
Wireless communication facilities	Allowed	Wireless communication facilities are allowed, subject to SRC chapter 703.
Drinking water treatment facilities	N	
Power generation facilities	N	
Data center facilities	N	
Fuel dealers	N	
Waste-related facilities	N	
Mining and Natural Resource Extraction		
Petroleum and natural gas production	N	
Surface mining	N	
Farming, Forestry, and Animal Services		
Agriculture	N	

Forestry	N	
Agriculture and forestry services	N	
Keeping of livestock and other animals	N	
Animal services	N	
Other Uses		
Temporary uses	P	Replacement single family dwelling is permitted, subject to SRC 701.020.
Home occupations	S	Home occupations are allowed, subject to SRC 700.020
Historic resource adaptive reuse pursuant to SRC chapter 230	Allowed	Historic resource adaptive reuse pursuant to SRC chapter 230 is allowed, subject to SRC 230.085

- (b) *Additional conditional uses.* In addition to the uses set forth in Table 626-1, any permitted, special, or conditional use within the Commercial/High Density Residential Overlay Zone shall be a conditional use within the overlay zone if developed with the following:
- (1) Drive-through.
- (c) *Continued uses.* Uses existing within the Commercial/High Density Residential Overlay Zone that were allowed as permitted, special, or conditional uses on November 30, 1998, but which would otherwise be made nonconforming uses by this chapter, are hereby deemed continued uses. The owner shall have the burden to demonstrate continued use status under this subsection.
- (1) A continued use may be intensified, and buildings or structures housing a continued use may be enlarged, rebuilt, or the exterior altered, provided such intensification, enlargement, rebuilding, or exterior alteration complies with all applicable standards in the underlying zone.
 - (2) A continued use may be extended onto other properties within the Commercial/High Density Residential Overlay Zone. The extension of a continued use onto other properties within the Commercial/High Density Residential Overlay Zone must comply with all applicable standards in the underlying zone.
 - (3) A continued use may be changed to any use that is allowed in the Commercial/High Density Residential Overlay Zone. Such change of use shall terminate the continued use status conferred by this subsection and the property must thereafter only be used for uses allowed in the Commercial/High Density Residential Overlay Zone.
 - (4) A determination by the Building Official that the building or structure housing a continued use is derelict or dangerous, as defined in SRC 50.600 and 56.230, shall terminate continued use status conferred by this subsection and the property may

thereafter only be used for uses allowed in the Commercial/High Density Residential Overlay Zone.

Sec. 626.020. - Development standards.

Development within the Commercial/High Density Residential Overlay Zone must comply with the development standards applicable in the underlying zone and the development standards set forth in this section. The development standards in this section are in addition to, and not in lieu of, all other applicable development standards in the underlying zone. Where the development standards in this section conflict with the development standards applicable in the underlying zone, the development standards in this section shall be the applicable development standard.

- (a) *Continued development.* Buildings and structures existing within the Commercial/High Density Residential Overlay Zone that conformed to the development standards existing on November 30, 1998, but which would otherwise be made nonconforming development by this chapter, are hereby deemed continued development. The owner shall have the burden to demonstrate continued development status under this subsection.
 - (1) Continued development may be enlarged, rebuilt, or the exterior altered, provided such enlargement, rebuilding, or exterior alteration complies with all applicable standards in the underlying zone.
 - (2) Continued development may be extended onto other properties within the Commercial/High Density Residential Overlay Zone. The extension of continued development onto other properties within the Commercial/High Density Residential Overlay Zone must comply with all applicable standards in the underlying zone.
 - (3) A determination by the Building Official that a continued development is derelict or dangerous, as defined in SRC 50.600 and 56.230, shall terminate the continued development status conferred by this subsection and the building or structure shall thereafter be deemed a nonconforming development.
- (b) *Development density.* Development within the Commercial/High Density Residential Overlay Zone shall conform to the density standards set forth in Table 626-2. Dwelling unit density cannot be varied or adjusted.

TABLE 626-2. DEVELOPMENT DENSITY		
Requirements	Standard	Limitations & Qualifications
Development Density		
<u>Three family, four family, and multiple family</u>	Min. 14 dwelling units per acre	
All other uses	Min. 0.6 FAR	Applicable to lots less than 32,000 sq. ft. in size.
	Min. 0.75 FAR	Applicable to lots 32,000 sq. ft. or greater in size.

- (c) *Dwelling units required.* Development on lots with frontage on Fourth Street NE shall provide residential dwelling units meeting the residential density requirements of Table 626-2 if:
- (1) The lot is greater than 32,000 square feet in size;
 - (2) The lot is vacant; or
 - (3) A use is expanded by more than 50 percent of the ground floor area.
- (d) *Setbacks.* Setbacks within the Commercial/High Density Residential Overlay Zone shall be provided as set forth in Table 626-3.

TABLE 626-3. SETBACKS		
Requirements	Standards	Limitations & Qualifications
Abutting Street		
Buildings		
All uses	None	
Accessory Structures		
Accessory to all uses	None	
Interior Front		
Buildings		
All uses	None	
Accessory Structures		
Accessory to all uses	None	
Interior Side		
Buildings		
All uses	None	
Accessory Structures		
Accessory to all uses	None	
Interior Rear		
Buildings		
All uses	Min. 5 ft.	
Accessory Structures		

Accessory to all uses	Min. 5 ft.	
-----------------------	------------	--

- (e) *Height.* Buildings and accessory structures within the Commercial/High Density Residential Overlay Zone shall conform to the height standards set forth in Table 626-4.

TABLE 626-4. HEIGHT		
Requirements	Standards	Limitations & Qualifications
Height		
Buildings		
Three family, four family, and multiple family	No Max.	
All other uses	Max. 50 ft.	
	No Max.	Applicable to mixed-use developments.
Accessory Structures		
Accessory to <u>three family, four family, and multiple family</u>	No Max.	
Accessory to all other uses	Max. 50 ft.	
	No Max.	Applicable to mixed-use developments.

- (f) *Screening.*

- (1) Uses shall be screened from abutting residentially zoned lots, and residential uses on abutting lots, by a minimum six-foot-high sight-obscuring fence, wall, or hedge.
- (2) Concertina or barbed wire fencing shall be screened from adjacent properties and abutting streets by sight-obscuring landscaping.

- (g) *Outdoor storage.* Outdoor storage of materials and equipment is prohibited.

Sec. 626.025. - Design review.

Design review under SRC chapter 225 is required for development within the Commercial/High Density Residential Overlay Zone as follows:

- (a) Multiple family development, other than multiple family development within a mixed-use building, shall be subject to design review according to ~~the multiple family design review guidelines or the multiple family design review standards~~ set forth in SRC chapter 702.
- (b) Multiple family development within a mixed-use building shall not be subject to design review according to ~~the multiple family design review guidelines or the multiple family design review standards~~ set forth in SRC chapter 702.

- (c) Residential care with ~~five~~three or more self-contained dwelling units shall be subject to design review according to ~~the multiple family design review guidelines or the multiple family design review standards set forth in SRC chapter 702.~~
- (d) Any development requiring historic design review shall only be subject to design review according to the historic design review standards or the historic design review guidelines set forth in SRC chapter 230.

Sec. 631.010. - Uses.

Except as otherwise provided in this section, any use that is a permitted, special, conditional, or prohibited use in the underlying zone is a permitted, special, conditional, or prohibited use in the Compact Development Overlay Zone.

- (a) *Continued uses.* ~~Four family uses and Mmultiple~~ family uses existing within the Compact Development Overlay Zone on January 1, 1999, but which would otherwise be made nonconforming uses by this chapter, are hereby deemed continued uses. The owner shall have the burden to demonstrate continued use status under this subsection.
 - (1) A continued use may be intensified or expanded, and buildings or structures housing a continued use may be enlarged, rebuilt, or the exterior altered, provided such intensification, expansion, enlargement, rebuilding, or exterior alteration complies with all applicable standards of the Multiple Family Residential-I (RM-I) Zone.
 - (2) Abandonment shall terminate the continued use status conferred by this subsection and the property may thereafter only be used for uses allowed in the Compact Development Overlay Zone. For purposes of this subsection, the term "abandonment" means the cessation of the use or structure for a continuous period of one year.
 - (3) A determination by the Building Official that the building or structure housing a continued use is derelict or dangerous, as defined in SRC 50.600 and 56.230, shall terminate the continued use status conferred by this subsection and the property may thereafter only be used for uses allowed in the Compact Development Overlay Zone.
 - (4) Continued uses are exempt from the development standards and the design review guidelines and design review standards of this chapter. Upon termination of continued use status, the development standards and the design review guidelines and design review standards of this chapter shall apply.
- (b) *Additional permitted uses.* The uses set forth in Table 631-1 are additional permitted (P) uses in the Compact Development Overlay Zone.

TABLE 631-1. ADDITIONAL PERMITTED USES		
Use	Status	Limitations & Qualifications
Household Living		
Single family	P	

Two family	P	
Three family	S	Subject to SRC 700.081.
Four family	N	
Multiple family	PN	

Sec. 631.015. - Development standards.

Development within the Compact Development Overlay Zone must comply with the development standards applicable in the underlying zone and the development standards set forth in this section. The development standards in this section are in addition to, and not in lieu of, all other applicable development standards in the underlying zone. Where the development standards in this section conflict with the development standards applicable in the underlying zone, the development standards in this section shall be the applicable development standard.

- (a) *Lot standards.* Lots within the Compact Development Overlay Zone shall conform to the standards set forth in Table 631-2.

TABLE 631-2. LOT STANDARDS		
Requirement	Standard	Limitations & Qualifications
Lot Area		
Single family	Min. 1,500 sq. ft.	Applicable to townhouses.
	Min. 3,000 sq. ft.	Applicable to all other single family.
Two family and multiple three family	Min. 3,000 sq. ft. per dwelling unit	
Lot Width		
Single family, two family, and multiple three family	Min. 20 ft.	
Lot Depth		
Single family, two family, and multiple three family	Min. 65 ft.	
	Min. 120 ft.	Applicable to double frontage lots.
Street Frontage		
Single family, two family, and multiple three family	Min. 20 ft.	

- (b) *Dwelling unit density.* Dwelling unit density within the Compact Development Overlay Zone shall conform to the standards set forth in this subsection. Dwelling unit density cannot be varied or adjusted.
- (1) *Minimum density.* There is no minimum dwelling unit density.
 - (2) *Maximum density.* The maximum dwelling unit density shall be 14 dwelling units per acre; provided, however:
 - (A) Not more than three dwelling units shall be permitted on an individual lot; and
 - (B) Not more than five townhouse dwelling units shall be attached in a single structure.
- (c) *Setbacks.* Setbacks within the Compact Development Overlay Zone shall be provided as set forth in Table 631-3.

TABLE 631-3. SETBACKS		
Requirement	Standard	Limitations & Qualifications
Abutting Street		
Buildings		
Single family (other than townhouses), and two family, and three family	Min. 12 ft.	
	Min. 20 ft.	Applicable along collector or arterial streets.
Accessory Structures		
Accessory to single family, and two family, and three family	None	Applicable to accessory structures not more than 4 ft. in height.
	Min. 12 ft.	Applicable to accessory structures greater than 4 ft. in height
	Min. 20 ft.	Applicable to accessory structures greater than 4 ft. in height when located in a yard adjacent to a collector or arterial street.
Interior Front		
Buildings		
Single family (other than townhouses), and two family, and three family	Min. 12 ft.	
Accessory Structures		
	None	Applicable to accessory structures not more than 4 ft. in height.

Accessory to single family, and two family, <u>and three family</u>	Min. 12 ft.	Applicable to accessory structures greater than 4 ft. in height
Interior Side		
Buildings		
Single family (other than townhouses)	Min. 3 ft.	Applicable to existing buildings.
	Min. 5 ft.	Applicable to new building.
Two family <u>and three family</u>	Min. 5 ft.	
Accessory Structures		
Accessory to single family, and two family, <u>and three family</u>	None	Applicable to accessory structures having at least 1 wall which is an integral part of a fence.
	Min. 5 ft.	Applicable to all other accessory structures.
Interior Rear		
Buildings		
Single family (other than townhouses), and two family, <u>and three family</u>	Min. 14 ft.	Applicable to any portion of a building not more than 1 story in height.
	Min. 20 ft.	Applicable to any portion of a building greater than 1 story in height.
Accessory Structures		
Accessory to single family, and two family, <u>and three family</u>	None	Applicable to accessory structures not more than 9 ft. in height.
	Min. 1 ft. for each 1 ft. of height over 9 ft.	Applicable to accessory structures greater than 9 ft. in height.
	Min. 1 ft.	Applicable to accessory structures adjacent to an alley, unless a greater setback is required based on the height of the accessory structure.

(d) *Lot coverage; height.* Buildings and accessory structures within the Compact Development Overlay Zone shall conform to the lot coverage and height standards set forth in Table 631-4.

TABLE 631-4. LOT COVERAGE; HEIGHT		
Requirement	Standard	Limitations & Qualifications

Lot Coverage		
Buildings and Accessory Structures		
Single family, two family, and multiple <u>three</u> family	Max. 60%	
Rear Yard Coverage		
Accessory Structures		
Accessory to single family, two family, and multiple <u>three</u> family	Max. 25%	
Height		
Buildings		
Single family, two family, and multiple <u>three</u> family	Max. 28 ft. or existing building height, whichever is greater	Applicable to existing buildings.
	Max. 35 ft.	Applicable to new buildings.
Accessory Structures		
Accessory to single family, two family, and multiple <u>three</u> family	Max. 15 ft.	

- (e) *Building separation.* A minimum ten-foot separation shall be provided between individual buildings containing dwelling units located on the same lot.
- (f) *Access.*
 - (1) Where a property abuts an alley, access to parking for single family, two family, and ~~multiple~~three family uses shall be taken from the alley.
 - (2) Within front yards abutting streets, no driveway serving single family, two family, or ~~multiple~~three family uses shall be more than one-half the width of the property frontage on the street or 20 feet, whichever is less. Flag lot accessways shall comply with the standards set forth in SRC 800.025.

Sec. 631.020. - Design review.

Design review under SRC chapter 225 is required for development within the Compact Development Overlay Zone as follows:

- (a) ~~Townhouses shall be subject to design review according to the design review guidelines or the design review standards set forth in SRC 631.025.~~
- (b) ~~Multiple family development shall be subject to design review according to the multiple family design review guidelines or the multiple family design review standards set forth~~

in SRC chapter 702, and the design review guidelines or the design review standards set forth in SRC 631.025.

- (eb) Any development requiring historic design review shall only be subject to design review according to the historic design review standards or the historic design review guidelines set forth in SRC chapter 230.

Sec. 631.025.—Design review guidelines and design review standards.

(a) ~~Building setbacks, location, size, and articulation.~~

(1) ~~Setbacks.~~

(A) ~~Design review guidelines.~~

- (i) Buildings shall be setback from abutting properties in a manner that provides an appropriate transition which encourages compatibility with the neighborhood.

(B) ~~Design review standards.~~

- (i) Buildings shall comply with the setbacks set forth in Table 631-5.

TABLE 631-5. BUILDING SETBACKS		
Requirement	Standard	Limitations & Qualifications
Abutting Street		
Buildings 28 feet or less in height	Min. 12 ft.	
	Min. 20 ft.	Applicable along collector or arterial streets.
Buildings greater than 28 feet in height	Min. 12 ft., plus 1 ft. for each 1 ft. of height over 28 ft.	
	Min. 20 ft., plus 1 ft. for each 1 ft. of height over 28 ft.	Applicable along collector or arterial streets.
Interior Front		
Buildings 28 feet or less in height	Min. 12 ft.	

Buildings greater than 28 feet in height	Min. 12 ft., plus 1 ft. for each 1 ft. of height over 28 ft.	
Interior Side		
Buildings 28 feet or less in height	Min. 5 ft.	Applicable to buildings, other than townhouses.
	None	Applicable to townhouses where they abut at the interior side lot line.
	Min. 5 ft.	Applicable to townhouses where they do not abut at the interior side lot line.
Buildings greater than 28 feet in height	Min 5 ft., plus 1 ft. for each 1 ft. of height over 28 ft.	Applicable to buildings, other than townhouses.
	None	Applicable to townhouses where they abut at the interior side lot line.
	Min. 5 ft., plus 1 ft. for each 1 ft. of height over 28 ft.	Applicable to townhouses where they do not abut at the interior side lot line.
Interior Rear		
Buildings	Min. 14 ft.	Applicable to any portion of a building not more than 1 story in height.
	Min. 20 ft.	Applicable to any portion of a building greater than 1 story in height.

~~(2) Building location, size, and orientation.~~

~~(A) Design review guidelines.~~

- ~~(i) A majority of the dwelling units shall be constructed within close proximity to the street right-of-way.~~
- ~~(ii) Buildings shall be located to reinforce the residential character of the neighborhood.~~
- ~~(iii) Where possible, dwelling unit entries shall be visible from the street and shall incorporate weather protection into their design.~~

- ~~(iv) The appearance of building bulk shall be minimized by:~~
- ~~(aa) Establishing a building offset interval along building facades; and~~
- ~~(bb) Dispersing windows throughout building facades.~~
- ~~(B) Design review standards:~~
 - ~~(i) Dwelling units within 28 feet of a street right-of-way shall provide entrances that face the street (see Figure 631-1).~~
 - ~~(ii) Buildings shall have no dimension greater than 100 feet.~~
 - ~~(iii) On sites with 75 feet or more of buildable width, a minimum of 50 percent of the buildable width shall be occupied by building(s) placed at the setback line. Accessory structures shall not apply towards meeting the required percentage.~~
 - ~~(iv) Every two attached dwelling units shall be offset from the next dwelling unit by at least four feet in depth (see Figure 631-2).~~
 - ~~(v) Individual and common entryways shall be articulated with a differentiated roof, awning, or portico (see Figure 631-1).~~
 - ~~(vi) Windows shall be provided in all habitable rooms, other than bathrooms, that face a street.~~

~~FIGURE 631-1. ARTICULATED BUILDING ENTRANCES FACING A STREET~~

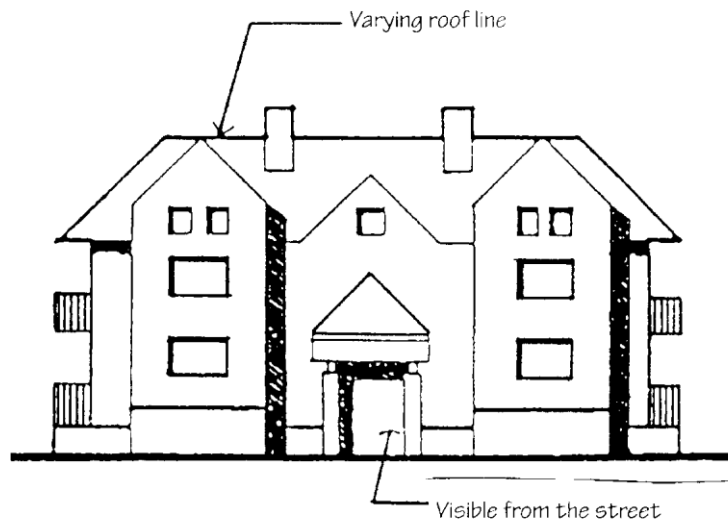
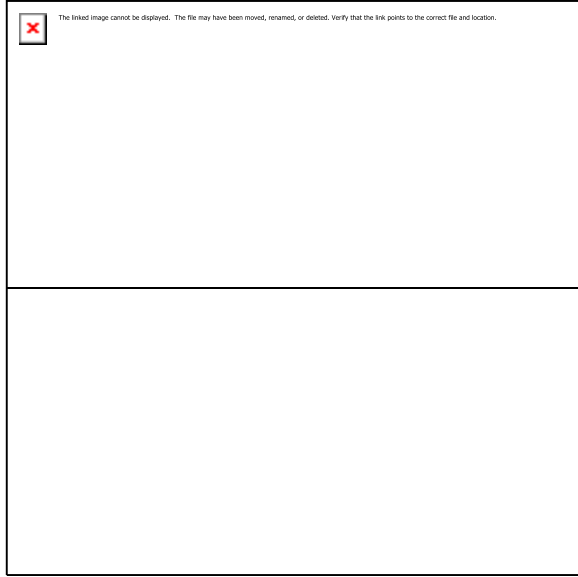
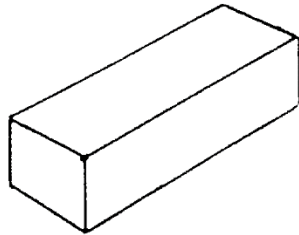
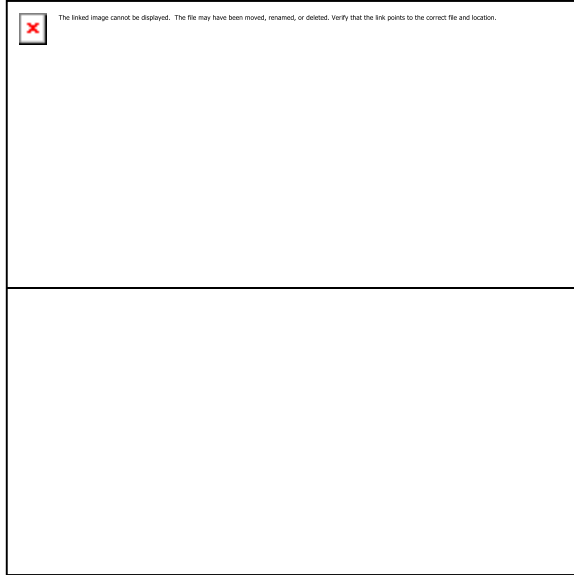
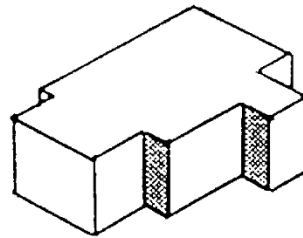

FIGURE 631-2. BUILDING OFFSETS AND ARTICULATION



**Undesirable
Architectural
Treatment**



**Horizontal Articulation
Added**

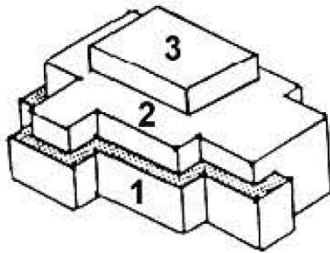

**Vertical Articulation
Added
(1-3 as examples)**

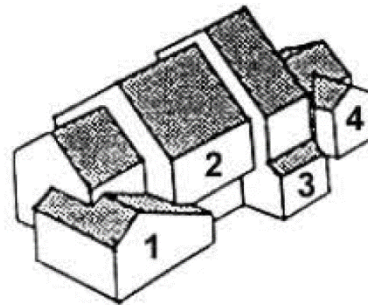

**Multi-Planed Roofs and Awnings Add
Desirable Articulation
(1-4 as examples)**

~~(b) — Open space:~~

~~(1) — Private open space:~~

~~(A) — Design review guidelines:~~

~~(i) — Individual private open space shall be provided for each dwelling unit.~~

~~(ii) — Private open space shall be easily accessible from the dwelling unit.~~

~~(iii) If private open space is located adjacent to common open space, a buffer between the two open space areas shall be provided.~~

~~(B) Design review standards:~~

~~(i) Private open space, meeting the size and dimension standards set forth in Table 631-5, shall be provided for each dwelling unit.~~

TABLE 631-5. PRIVATE OPEN SPACE SIZE AND DIMENSIONS		
Location of Dwelling Unit	Minimum Open Space Area Size	Minimum Dimension
Not more than 5 feet above finished grade	96 sq. ft.	6 ft.
More than 5 feet above finished grade	48 sq. ft.	6 ft.

~~(ii) Private open space shall be located contiguous to the dwelling unit, with direct access to the private open space provided through a doorway (see Figure 631-3).~~

~~(iii) Private open space shall be visually separated from common open space through the use of perimeter landscaping or fencing.(see Figure 631-3).~~

FIGURE 631-3. PRIVATE OPEN SPACE

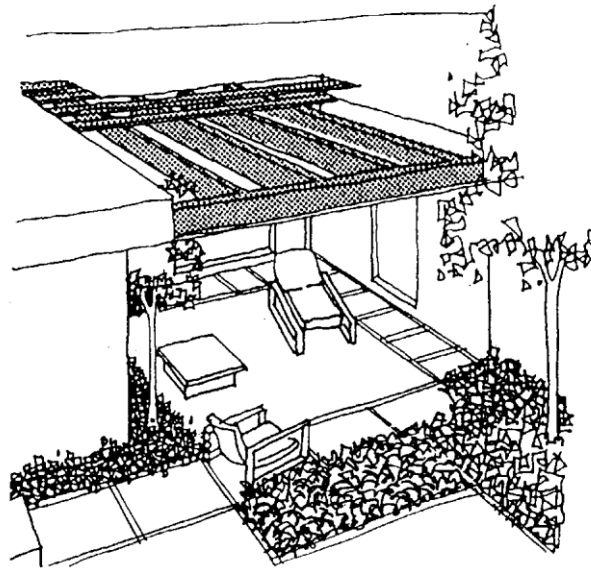
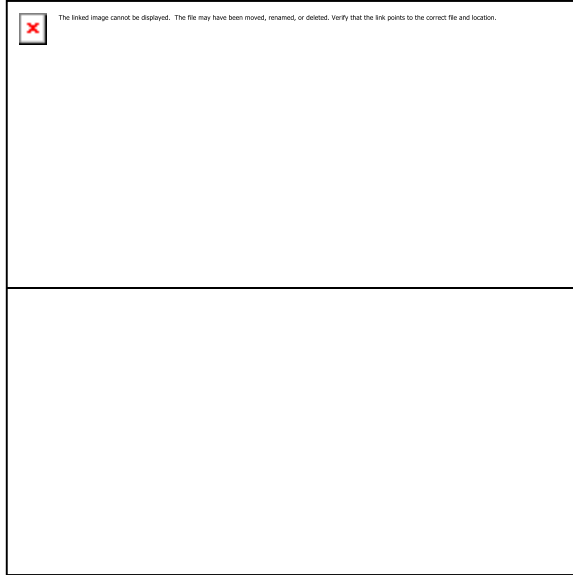

(c) — *Parking, access, and circulation.*

(1) — *General parking and site access.*

(A) — *Design review guidelines.*

- (i) — Parking areas and driveways shall be located and designed to minimize impacts to abutting properties and promote human scale within the development.

(B) — *Design review standards.*

- (i) — Not more than one driveway approach shall be provided to an individual lot.
- (ii) — Parking areas shall not occupy more than 50 percent of any street frontage.
- (iii) — Parking areas shall be setback a minimum of 20 feet from the public right-of-way.

- ~~(iv) — Garages shall be setback from the street at least four feet further than the front wall of the main building.~~
- ~~(v) — The design and materials of garages and carports shall be compatible with the design and materials of the dwelling units.~~

~~(d) — *Landscaping.*~~

~~(1) — *General landscaping.*~~

~~(A) — *Design review guidelines.*~~

- ~~(i) — Landscaping shall be provided to buffer the development from abutting uses.~~
- ~~(ii) — A variety of trees and other plant materials shall be distributed throughout the site and located adjacent to buildings and parking areas.~~
- ~~(iii) — Trees shall be planted within the street right-of-way to enhance the residential character of the development.~~

~~(B) — *Design review standards.*~~

- ~~(i) — A minimum of one tree shall be planted or retained for every 2,000 square feet of gross site area.~~
- ~~(ii) — Trees shall be planted to provide canopy coverage for at least one-third of the open space and setbacks within 15 years of planting. Existing trees that are retained may be counted towards meeting this requirement.~~
- ~~(iii) — Within the street right-of-way, trees shall be planted at one of the following ratios:
 - ~~(aa) — *Canopy trees.* One canopy tree shall be planted for every 50 feet of street frontage; or~~
 - ~~(bb) — *Columnar trees.* One columnar tree shall be planted for every 30 feet of street frontage.~~~~
- ~~(iv) — A minimum of two plant units shall be provided adjacent to the primary entrance of each dwelling unit, or combination of dwelling units.~~
- ~~(v) — Landscaping shall be distributed around the perimeter of buildings as follows:
 - ~~(aa) — *Trees.* Trees shall be provided in the minimum amount of ten plant units per 60 linear feet of exterior building wall. The trees shall be distributed around the perimeter of the building and located not more than 25 feet from the exterior wall. Existing trees that are retained may be counted towards meeting this requirement.~~
 - ~~(bb) — *Shrubs.* Shrubs shall be provided in the minimum amount of one plant unit per 15 linear feet of exterior building wall. The shrubs shall be distributed around the perimeter of the building and located not more than 25 feet from the exterior wall.~~~~
- ~~(vi) — Landscaping shall be distributed around the perimeter of parking areas as follows:~~

- (aa) ~~*Trees.* A minimum of one canopy tree shall be planted every 50 feet along the perimeter of the parking area. The canopy trees shall be located within 15 feet of the edge of the parking area (see Figure 631-4). Existing canopy trees that are retained may be counted towards meeting this requirement.~~

~~FIGURE 631-4. PARKING AREA PERIMETER CANOPY TREES~~

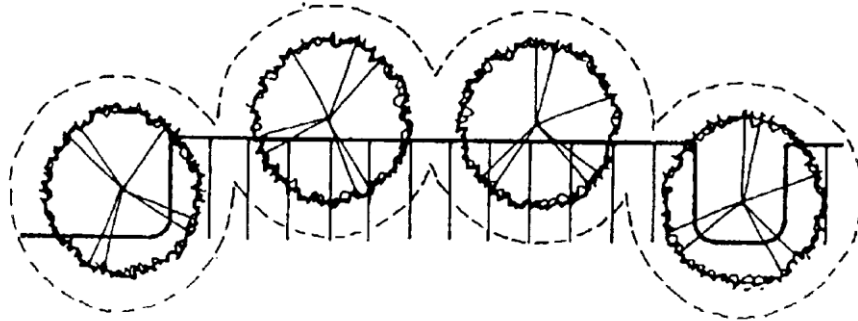
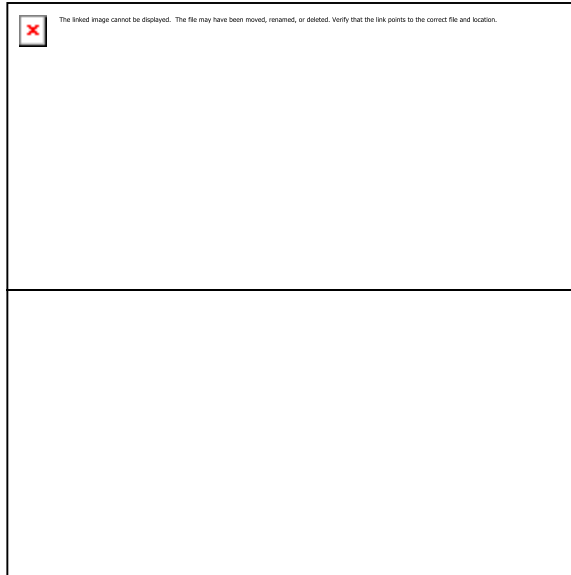

- ~~(e) *Crime prevention through environmental design.*~~

- ~~(1) *Safety features for residents.*~~

- ~~(A) *Design review guidelines.*~~

- ~~(i) Developments shall be designed in a manner that considers crime prevention and resident safety.~~
- ~~(ii) Landscaping and fencing shall be provided in a manner that does not obscure visual surveillance of common open space, parking areas, or dwelling unit entryways.~~

- ~~(B) *Design review standards.*~~

- ~~(i) Fences, walls, and plant materials shall not be installed between street-facing dwelling units and public or private streets in locations that obstruct the visibility~~

~~of dwelling unit entrances from the street. For purposes of this standard, the term "obstructed visibility" means the entry is not in view from the street along one-half or more of the dwelling unit's frontage.~~

~~(ii) — Lighting shall be provided that illuminates all exterior dwelling unit entrances, pedestrian walkways, and parking areas within the development.~~

~~(iii) — A completed "Enhanced Safety Assessment Report for Multi-Family Construction" shall be submitted. Compliance with the provisions of the assessment is advisable but not mandatory.~~

Sec. 700.005. - Special uses, generally.

- (a) A special use is a use that, while allowed in certain zones and overlay zones, has the potential for creating impacts that merit special standards beyond those that would otherwise apply to uses generally in that zone or overlay zone. A use that is designated as a special use in one zone or overlay zone may be a permitted use in another zone or overlay zone.
- (b) The special use standards set forth in this chapter apply only where a use is designated as a special use.
- (c) A special use that complies with the standards set forth in this chapter and with the applicable standards of the UDC does not require approval beyond that required for a use that is a permitted use.
- ~~(d) The special use standards set forth in this chapter may be modified, unless otherwise specially provided in this chapter. Modification to a special use standard shall be made pursuant to conditional use approval, as provided in SRC chapter 240. In no case shall conditional use approval allow a standard that is less restrictive than the development standards established in the zone or overlay zone. Except as specifically provided in this section, a project may only deviate from the special use standards in this chapter through conditional use approval as provided in SRC chapter 240, and not through an adjustment or variance.~~
- (e) Notwithstanding subsection (d) of this section, modifications deviation from a special use standard for accessory dwelling units and three family and four family uses shall be made pursuant to adjustment approval, as provided in SRC chapter 250, or variance approval, as provided in SRC chapter 245.

Sec. 700.010. - Basic education.

Where designated as a special use, basic education shall comply with the additional standards set forth in this section.

~~(a) — Lot area. Minimum three acres.~~

~~(a) — Setbacks.~~

- (1) Buildings shall be set back from every lot line a minimum of one foot for each one foot of building height; provided, however, the setback need not exceed 35 feet in depth.
- (2) Off-street parking and loading areas shall be setback a minimum of ten feet from any abutting residentially zoned property or property used for a residential use.

- (c) ~~Lot coverage. No main building or combination of classroom buildings shall occupy more than 30 percent of the lot area.~~

Sec. 700.081. Three family and four family uses.

Where designated as a special use, three family and four family uses shall comply with the additional standards set forth in this section.

- (a) Buildings shall be constructed with at least one primary entrance that is articulated with a differentiated roof, awning, or porch.
- (b) At least one primary building entrance shall be oriented toward a street or front lot line. Alternatively, primary building entrances may be oriented toward a common open space that is adjacent to the street.
- (c) Buildings shall have a pitched roof with a slope of not less than three feet in height for each 12 feet in width.
- (d) Off-street vehicle use areas shall not exceed 50 percent of the buildable width along each street.

~~CHAPTER 702. MULTIPLE FAMILY DESIGN REVIEW GUIDELINES AND STANDARDS~~

~~Sec. 702.001. Purpose.~~

~~The purpose of this chapter is to establish design review guidelines and design review standards for multiple family development.~~

~~Sec. 702.005. Multiple family design review.~~

- (a) ~~Except as provided under subsection (b) of this section, and unless otherwise provided in the UDC, design review under SRC chapter 225 is required for all multiple family development.~~
- (b) ~~Exceptions. Multiple family design review is not required for:~~
- (A) ~~Multiple family development within a mixed-use building.~~
- (B) ~~Multiple family development within:~~
- (i) ~~The Central Business District (CB) Zone.~~
- (ii) ~~The South Waterfront Mixed Use (SWMU) Zone.~~
- (iii) ~~The Neighborhood Center Mixed Use (NCMU) Zone.~~
- (iv) ~~The Broadway/High Street Retail Overlay Zone~~
- (v) ~~The Broadway/High Street Housing Overlay Zone.~~
- (vi) ~~The General Retail/Office Overlay Zone.~~
- (vii) ~~The Front Street Overlay Zone.~~
- (viii) ~~The Riverfront High Density Residential Overlay Zone.~~
- (ix) ~~The Riverfront Overlay Zone.~~

- (x) ~~The Salem Downtown Historic District.~~
- (xi) ~~The Public and Private Health Services (PH) Zone.~~
- (xii) ~~The Mixed Use I (MU-I) Zone.~~
- (xiii) ~~The Mixed Use II (MU-II) Zone.~~

~~Sec. 702.010. — Multiple family design review guidelines and design review standards.~~

~~Multiple family development shall comply with either all of the applicable design review guidelines or all of the applicable design review standards set forth in this chapter. The design review guidelines and the design review standards set forth in this chapter are in addition to, and not in lieu of, all other applicable development standards in the UDC. Where the design review guidelines or the design review standards conflict with the development standards in the UDC, the design review guidelines and the design review standards shall be the applicable development standard.~~

~~Sec. 702.015. — Open space design review guidelines and standards.~~

~~(a) — *Open space design goals and objectives.*~~

~~(1) — *Design goals.*~~

- ~~(A) — Implement Council goals and neighborhood policies that encourage open space in multiple family developments;~~
- ~~(B) — Provide common and private open space for active and passive uses;~~
- ~~(C) — Encourage preservation of the natural open qualities which may exist on a site;~~
- ~~(D) — Ensure that open space is accessible with pedestrian pathways available to all residents of the development; and~~
- ~~(E) — Provide visual relief from structural bulk.~~

~~(2) — *Design objectives.*~~

- ~~(A) — Locate open space throughout the site and in proximity to dwelling units;~~
- ~~(B) — Provide centrally located open space in increments large enough to accommodate intended activities;~~
- ~~(C) — Integrate open space with the natural topography;~~
- ~~(D) — Maximize private open space for each dwelling unit;~~
- ~~(E) — Preserve exposure to light, air, and visual access;~~
- ~~(F) — Provide children's play areas interspersed and centrally located within multiple family developments;~~
- ~~(G) — Maximize visual relief from structural bulk;~~
- ~~(H) — Provide separation between buildings on and off site;~~
- ~~(I) — Promote active recreational opportunities within open space; and~~
- ~~(J) — Provide pedestrian access to all common open space areas to promote active use.~~

FIGURE 702-1. MULTIPLE FAMILY CONCEPTUAL SITE DESIGN

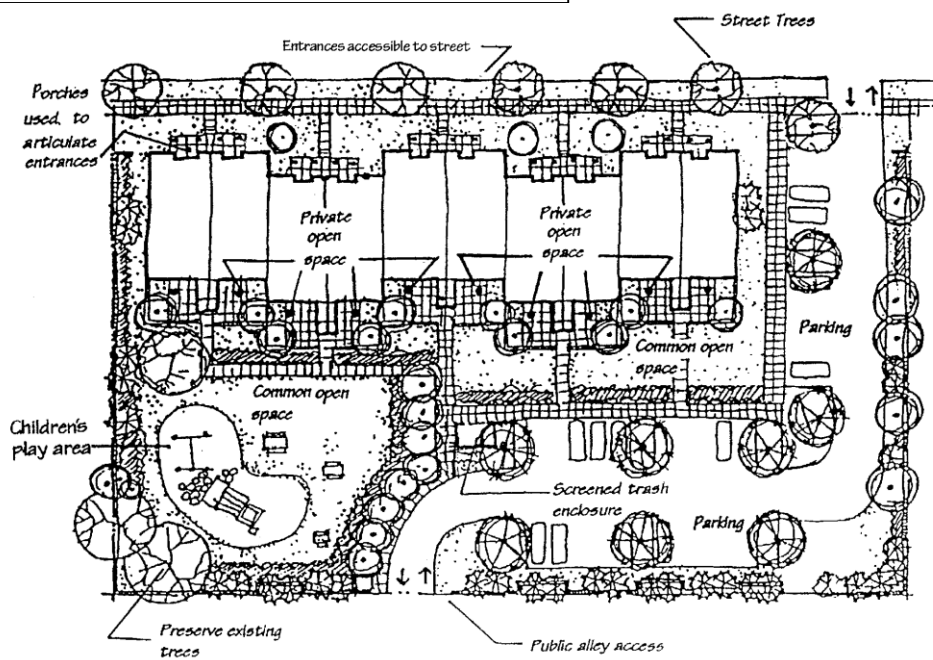
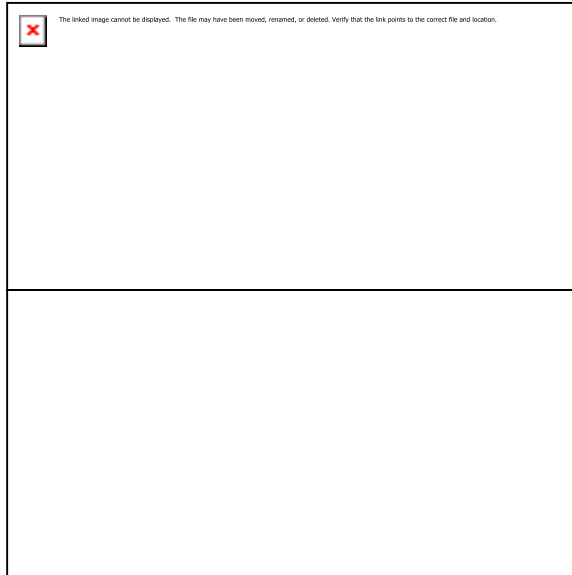

(b) ~~Common open space.~~

(1) ~~Design review guidelines.~~

- (A) ~~A variety of open space areas of sufficient size shall be provided for use by all residents.~~
- (B) ~~Common open space shall be distributed around buildings and throughout the site.~~
- (C) ~~The amount of perimeter setbacks used for common open space shall be minimized.~~

(2) ~~Design review standards.~~

- (A) ~~Common open space shall be provided in all newly constructed multiple family developments with five or more dwelling units as follows:~~
- (i) ~~A minimum of 30 percent of the gross site area shall be designated and permanently reserved as common open space.~~
 - (ii) ~~Not more than 50 percent of the common open space shall be located in the required perimeter setbacks of the development.~~
 - (iii) ~~Not more than 15 percent of the common open space shall be located on land with slopes greater than 25 percent.~~
 - (iv) ~~Indoor or covered recreation space may count toward the common open space requirement, provided such indoor or covered space does not exceed 30 percent of the common open space.~~
 - (v) ~~At least one of the common open space areas provided within the development shall meet the size and dimensional standards set forth in Table 702-1.~~

TABLE 702-1. COMMON OPEN SPACE AREA SIZE AND DIMENSIONS		
Number of Dwelling Units	Minimum Open Space Area Size	Minimum Horizontal Dimension
5 to 10	500 sq. ft.	20 ft.
11 to 20	750 sq. ft.	25 ft.
More than 20	1000 sq. ft., plus an additional 250 sq. ft. for every 20 units, or portion thereof, over 20 units.	25 ft.

(c) ~~Children's play areas and adult recreation areas.~~

(1) ~~Design review guidelines.~~

- (A) ~~A variety of common open area opportunities shall be provided for enjoyment by all residents.~~
- (B) ~~Children's play and/or adult recreation areas shall be located centrally within the development.~~
- (C) ~~Children's play areas, if provided, shall be located in a manner to incorporate safety into the design by including such things as locating play areas to be visible from dwelling units, locating play areas away from physical barriers such as driveways and parking areas, and selection of play equipment with safe designs.~~

(2) ~~Design review standards.~~

- (A) ~~Outdoor children's play and/or adult recreation areas shall be provided, as set forth in Table 702-2, in all newly constructed multiple family developments with 20 or~~

~~more dwelling units. Outdoor children's play and/or adult recreation areas count toward meeting the common open space requirement.~~

TABLE 702-2. OUTDOOR CHILDREN'S PLAY AREAS AND ADULT RECREATION AREAS		
Number of Dwelling Units	Play/Recreation Area Size	Minimum Horizontal Dimension
1 to 19	N/A	N/A
20	950 sq. ft.	25 ft.
More than 20	950 sq. ft., plus an additional 250 sq. ft. for every 20 units, or portion thereof, over 20 units.	25 ft.

-

- ~~(B) Outdoor children's play and/or adult recreation areas shall be located centrally within the development.~~
- ~~(C) Outdoor children's play and/or adult recreation areas shall not be located within required setbacks.~~
- ~~(D) Outdoor children's play and/or adult recreation areas may be located within stormwater detention areas if the area meets the following:

 - ~~(i) No dimension is less than 15 feet wide;~~
 - ~~(ii) Side slopes are 4:1 or less; and~~
 - ~~(iii) There is a minimum 250 square foot area with a slope no greater than two percent.~~~~
- ~~(E) A minimum 30-inch tall fence shall be installed to separate outdoor children's play areas from any parking lot, drive aisle, or street.~~

~~(d) Private open space.~~

~~(1) Design review guidelines:~~

- ~~(A) Individual private open space shall be provided for each dwelling unit in all newly constructed multiple family developments.~~
- ~~(B) Private open space shall be easily accessible from the dwelling unit.~~
- ~~(C) If private open space is located adjacent to common open space, a buffer between the two open space areas shall be provided.~~

~~(2) Design review standards:~~

- (A) ~~Private open space, meeting the size and dimension standards set forth in Table 702-3, shall be provided for each dwelling unit in all newly constructed multiple family developments.~~

TABLE 702-3. PRIVATE OPEN SPACE SIZE AND DIMENSIONS		
Location of Dwelling Unit	Minimum Open Space Area Size	Minimum Dimension
Not more than 5 feet above finished grade	96 sq. ft.	6 ft.
More than 5 feet above finished grade	48 sq. ft.	6 ft.

- (B) ~~Private open space shall be located contiguous to the dwelling unit, with direct access to the private open space provided through a doorway.~~
- (C) ~~Private open space shall be visually separated from common open space through the use of perimeter landscaping or fencing.~~

~~Sec. 702.020.— Landscaping design review guidelines and standards.~~

~~(a) — Landscaping design goals and objectives.~~

~~(1) — Landscaping goals.~~

- (A) ~~Encourage a quality living environment for all residents of the City;~~
- (B) ~~Ensure aesthetic values in the construction of multiple family developments;~~
- (C) ~~Achieve compatibility between multiple family developments and surrounding land uses; and~~
- (D) ~~Encourage a mix of landscaping treatments and techniques to enhance multiple family developments.~~

~~(2) — Landscaping objectives.~~

- (A) ~~Provide adequate separation between abutting properties;~~
- (B) ~~Mitigate noise;~~
- (C) ~~Screen objectionable views;~~
- (D) ~~Establish a sense of place;~~
- (E) ~~Provide definition to dwelling unit entries and pedestrian pathways;~~
- (F) ~~Promote safety, security, and privacy;~~
- (G) ~~Enhance structural elements;~~
- (H) ~~Provide visual relief from blank exterior walls, building mass, and bulk;~~
- (I) ~~Help retain the long term value of property;~~

- ~~(J) Minimize the visual impact of impervious surfaces; and~~
- ~~(K) Provide protection from winter wind and summer sun.~~

~~(b) General landscaping.~~

~~(1) Design review guidelines.~~

- ~~(A) A variety of tree types shall be distributed throughout the site to maximize tree canopy.~~
- ~~(B) Landscaping shall be used to shield the site from winter winds and summer sun.~~
- ~~(C) Existing trees shall be preserved to the maximum extent possible.~~
- ~~(D) Where a development site abuts property zoned Residential Agricultural (RA) or Single Family Residential (RS), an appropriate combination of landscaping and screening shall be provided that is sufficient to buffer between the multiple family development and the abutting RA or RS zoned property.~~

~~(2) Design review standards.~~

- ~~(A) A minimum one tree shall be planted or preserved for every 2,000 square feet of gross site area.~~
- ~~(B) Trees shall be planted that, at maturity, will provide canopy coverage over at least one third of the open space and setbacks.~~
- ~~(C) Landscaping, or a combination of landscaping and fencing, shall be provided for developments abutting arterial or collector streets to prevent headlights from shining into the windows of buildings.~~
- ~~(D) Where a development site abuts property that is zoned Residential Agricultural (RA) or Single Family Residential (RS), a combination of landscaping and screening shall be provided to buffer between the multiple family development and the abutting RA or RS zoned property. The landscaping and screening shall include the following:
 - ~~(i) A minimum of one tree, not less than 1.5 inches in caliper, for every 30 linear feet of abutting property width; and~~
 - ~~(ii) A minimum six-foot tall, decorative, sight-obscuring fence or wall. The fence or wall shall be constructed of materials commonly used in the construction of fences and walls, such as wood, stone, rock, brick, or other durable materials. Chainlink fencing with slats shall be not allowed to satisfy this standard.~~~~

~~(c) Street frontage.~~

~~(1) Design review guidelines.~~

- ~~(A) The residential character of the site shall be enhanced with trees planted within the public right-of-way.~~

~~(2) Design review standards.~~

- ~~(A) Trees shall be planted within the public right-of-way at one of the following ratios:
 - ~~(i) Canopy trees. One canopy tree per 50 linear feet of street frontage, or fraction thereof.~~~~

- (ii) ~~Columnar trees. One columnar tree per 40 linear feet of street frontage, or fraction thereof.~~

FIGURE 702-2. ~~CANOPY AND COLUMNAR TREES~~

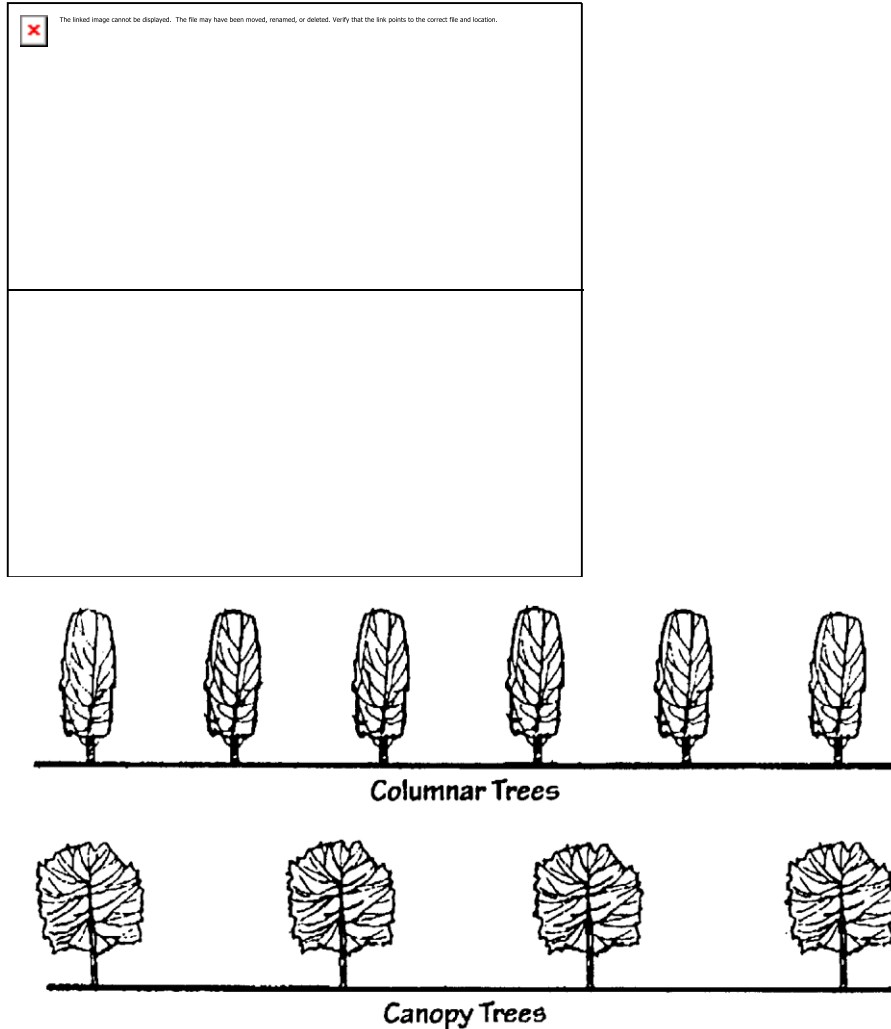

(d) ~~Building exteriors.~~

(1) ~~Design review guidelines.~~

- (A) ~~Landscaping shall be planted to define and accentuate the primary entryway of each dwelling unit, or combination of dwelling units.~~
- (B) ~~Vertical and horizontal landscape elements shall be provided along all exterior walls to soften the visual impact of buildings and create residential character.~~

(2) ~~Design review standards.~~

- (A) ~~A minimum of two plant units, as set forth in SRC chapter 807, Table 807-2, shall be provided adjacent to the primary entryway of each dwelling unit, or combination of dwelling units.~~

(B) ~~New trees shall be planted, or existing trees shall be preserved, at a minimum density of ten plant units per 60 linear feet of exterior building wall. Such trees shall be located not more than 25 feet from the edge of the building footprint.~~

(C) ~~Shrubs, when used, shall be distributed around the perimeter of buildings at a minimum density of one plant unit per 15 linear feet of exterior building wall.~~

(e) ~~Privacy:~~

(1) ~~Design review guidelines:~~

(A) ~~Landscaping, or a combination of landscaping and fencing, shall be used to buffer the multiple family development from abutting properties.~~

(B) ~~Landscaping shall be used to enhance the privacy of dwelling units. Methods may include fencing in combination with plant units.~~

(2) ~~Design review standards:~~

(A) ~~Ground level private open space shall be physically and visually separated from common open space with perimeter landscaping or perimeter fencing (see Figure 702-3).~~

FIGURE 702-3. SEPARATION OF PRIVATE AND COMMON OPEN SPACE

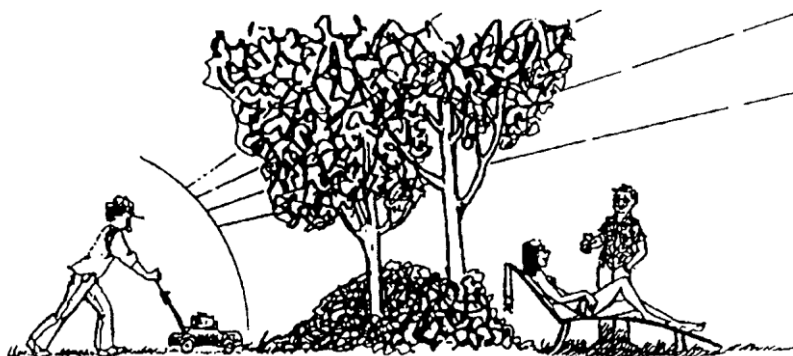
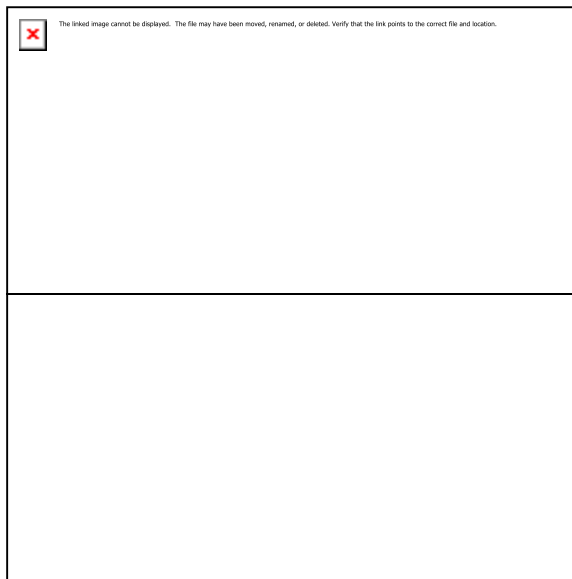

(f) *Parking areas.*

(1) *Design review guidelines.*

(A) Canopy trees shall be distributed throughout the interior, and planted along the perimeter, of parking areas (see Figure 702-4 and Figure 702-5).

(2) *Design review standards.*

(A) A minimum of one canopy tree shall be planted along every 50 feet of the perimeter of parking areas. Trunks of the trees shall be located within 15 feet of the edge of the parking area (see Figure 702-4).

(B) Canopy trees shall be planted within planter bays (see Figure 702-5).

(C) Planter bays shall be a minimum width of 18 feet.

FIGURE 702-4. PARKING LOT LANDSCAPING

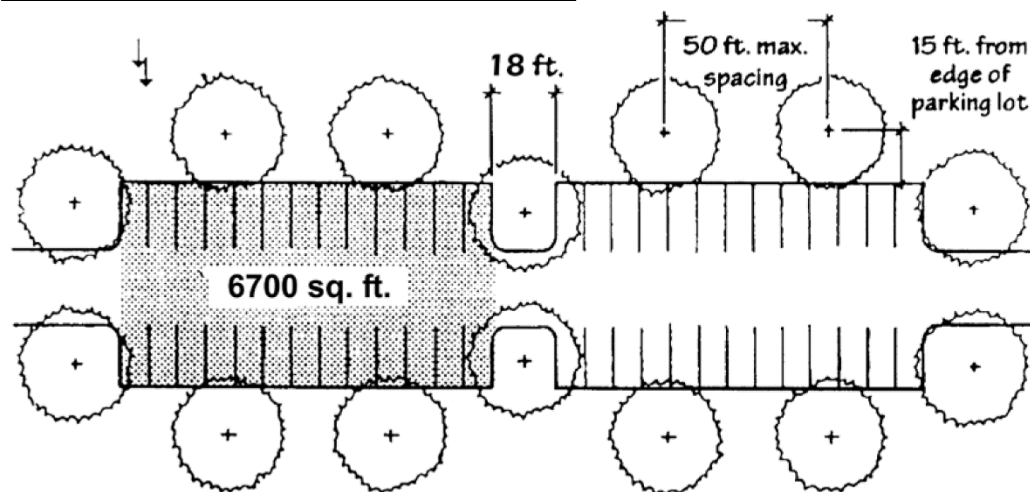
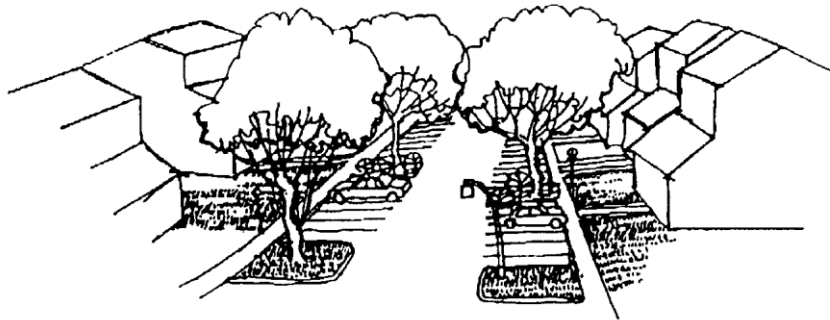
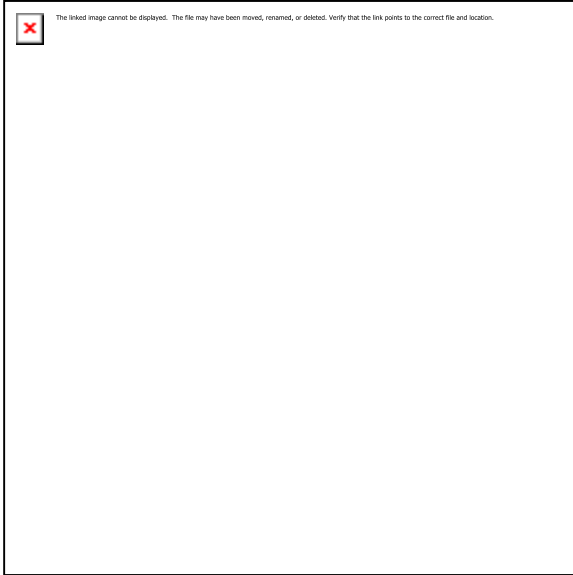

FIGURE 702-5. PARKING LOT WITH CANOPY TREES



~~Sec. 702.025.— Crime prevention through environmental design.~~

~~(a) — Safety features for residents~~

~~(1) — Design review guidelines.~~

~~(A) — Multiple family developments shall be designed in a manner that considers crime prevention and resident safety.~~

~~(B) — Landscaping and fencing shall be provided in a manner that does not obscure visual surveillance of common open space, parking areas, or dwelling unit entryways.~~

~~(2) — Design review standards.~~

~~(A) — Fences, walls, and plant materials shall not be installed between street-facing dwelling units and public or private streets in locations that obstruct the visibility of dwelling unit entrances from the street. For purposes of this standard, the term "obstructed visibility" means the entry is not in view from the street along one-half or more of the dwelling unit's frontage.~~

~~(B) — Landscaping and fencing adjacent to common open space, parking areas, and dwelling unit entryways shall be limited to a maximum height of three feet.~~

- ~~(C) Windows shall be provided in all habitable rooms, other than bathrooms, that face common open space, parking areas, and pedestrian paths.~~
- ~~(D) Lighting shall be provided that illuminates all exterior dwelling unit entrances, parking areas, and pedestrian paths within the development.~~
- ~~(E) A completed "Enhanced Safety Assessment Report for Multi-Family Construction" shall be submitted. Compliance with the provisions of the assessment is advisable but not mandatory.~~

~~Sec. 702.030. Parking, site access, and circulation.~~

~~(a) Parking, site access, and circulation design goals and objectives.~~

~~(1) Parking, site access, and circulation goals.~~

- ~~(A) Ensure safe and efficient site access, pedestrian and vehicle circulation, and parking in multiple family developments;~~
- ~~(B) Promote circulation and access for all modes of transportation;~~
- ~~(C) Encourage aesthetic and functional site design with consideration for natural contours and topography as it relates to parking and site access in multiple family developments; and~~
- ~~(D) Encourage pedestrian and vehicle circulation linkages which will integrate amenities within multiple family developments and with the surrounding area.~~

~~(2) Parking, site access, and circulation objectives.~~

- ~~(A) Provide transportation connections to surrounding areas;~~
- ~~(B) Promote accessibility to and within the site;~~
- ~~(C) Integrate the design of parking areas and pedestrian pathways with natural contours and topography;~~
- ~~(D) Minimize views of parking areas from public rights-of-way;~~
- ~~(E) Provide clear and identifiable connections to and between buildings;~~
- ~~(F) Minimize vehicle, pedestrian, and bicycle circulation conflicts;~~
- ~~(G) Provide adequate lighting levels for parking and pedestrian pathways;~~
- ~~(H) Promote the separation of pedestrian, bicycle, and vehicular traffic;~~
- ~~(I) Maximize the convenience of parking for residents;~~
- ~~(J) Provide pedestrian access to common open space;~~
- ~~(K) Locate loading and service areas for ease of use with minimal conflict with on-site parking and circulation activities;~~
- ~~(L) Locate building entrances and exits to provide direct connections between parking areas and the street;~~
- ~~(M) Provide compatibility in design and materials between parking and the dwelling units; and~~
- ~~(N) Minimize the expanse of continuous parking areas.~~

~~(b) General parking and site access.~~

~~(1) Design review guidelines.~~

- ~~(A) Parking areas shall be designed to minimize the expanse of continuous parking (see Figure 702-6).~~
- ~~(B) Pedestrian pathways shall be provided that connect to and between buildings, common open space, parking areas, and surrounding uses (see Figure 702-7).~~
- ~~(C) Parking shall be located to maximize the convenience of residents.~~
- ~~(D) Parking areas and circulation systems shall be designed in a manner that considers site topography, natural contours, and any abutting properties zoned Residential Agriculture (RA) or Single Family Residential (RS).~~

~~(2) Design review standards.~~

- ~~(A) Parking areas greater than 6,700 square feet in area shall be physically and visually separated with landscaped planter bays that are a minimum of 18 feet in width. Individual parking areas may be connected by an aisle or driveway (see Figure 702-6).~~
- ~~(B) Pedestrian pathways shall be provided that connect to and between buildings, common open space, and parking areas (see Figure 702-7).~~
- ~~(C) Pathways connecting to and between buildings, common open space, and parking areas shall be separated from dwelling units by a minimum distance of ten feet. Separation shall be measured from the pathway edge closest to any dwelling unit.~~
- ~~(D) Garages, carports, and parking areas shall be set back a minimum of 20 feet from the public right-of-way.~~
- ~~(E) Where a development site abuts, and is located uphill from, property zoned Residential Agriculture (RA) or Single Family Residential (RS), and the slope of the development site within 40 feet of the abutting RA or RS zoned property is 15 percent or greater, parking areas shall be set back not less than 20 feet from the property line of the abutting RA or RS zoned property. Decorative walls, earthen berms, fencing, landscaping, or any combination thereof shall be provided to prevent glare from headlights onto abutting properties.~~
- ~~(F) The design and materials of garages and carports shall be compatible with the design and materials of the dwelling units.~~
- ~~(G) Areas of slope shall be avoided for placement of parking areas.~~
- ~~(H) Disturbance of environmentally sensitive areas shall be minimized in placement of parking areas.~~

FIGURE 702-6. CONCEPTUAL PARKING AREA LAYOUT

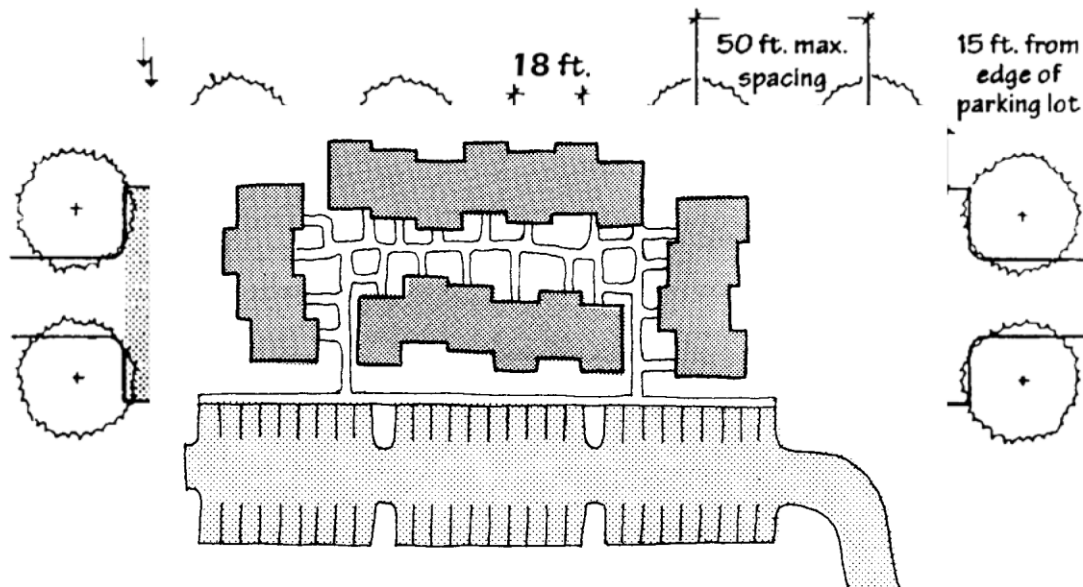
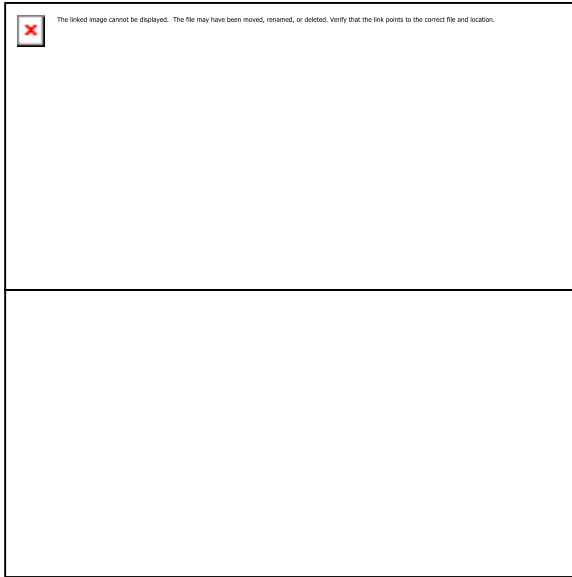

FIGURE 702-7. PEDESTRIAN PATHWAYS [GRAPHIC]

(c) *Site access.*

(1) *Design review guidelines.*

- (A) ~~Accessibility to and from the site shall be provided for both automobiles and pedestrians.~~
- (B) ~~Site access shall be provided in a manner that minimizes vehicle and pedestrian conflicts.~~
- (C) ~~Where possible, driveway access shall be provided onto collector or local streets rather than arterial streets.~~
- (D) ~~Where possible, driveway access shall be consolidated with either existing or future driveways serving adjacent developments.~~

~~(E) Parking areas shall be located to minimize their visibility from the public right-of-way and abutting properties (see Figure 702-8).~~

~~(2) Design review standards:~~

~~(A) Pedestrian pathways shall be provided that connect the development to the public sidewalks.~~

~~(B) Direct access from the street to individual units, clusters of units, or common interior lobbies shall be provided for residential buildings located within 32 feet of a public street.~~

~~(C) Where the development has frontage on more than one street, and such streets have different classifications in the Salem Transportation System Plan, driveway access shall be provided to the street with the lowest classification.~~

~~(D) Where possible, driveway access shall be consolidated with either existing or future driveways serving adjacent developments.~~

~~(E) Walls, fences, or landscaping shall be provided to buffer parking areas from public streets and abutting properties (see Figure 702-8).~~

~~FIGURE 702-8. PARKING AREAS BUFFERED FROM RIGHT-OF-WAY~~

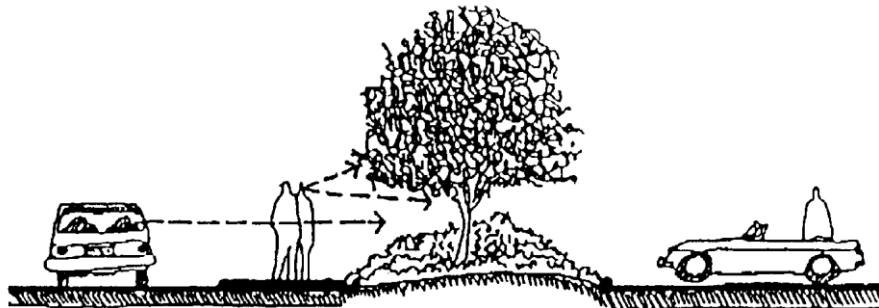
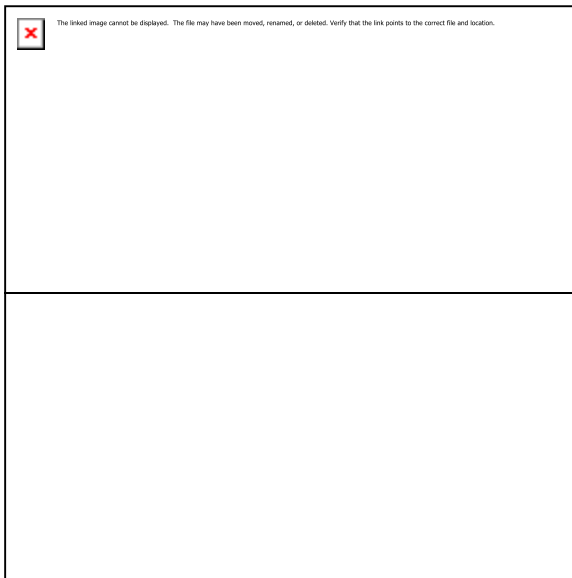

~~Sec. 702.035. Building mass and facade design.~~

- (a) ~~Building mass and facade design goals and objectives.~~
- (1) ~~Building mass and facade design goals.~~
- (A) ~~Ensure that structures do not present excessive visual mass or bulk to public view or to adjoining properties;~~
 - (B) ~~Achieve architecturally defined entryways, and building design that relates to human scale;~~
 - (C) ~~Encourage aesthetically pleasing, interesting, and functional architecture and site design, including compatibility between parking facilities and the dwelling units;~~
 - (D) ~~Provide architectural design that integrates well with adjoining development; and~~
 - (E) ~~Promote interesting and non-monotonous architecture and site design.~~
- (2) ~~Building mass and facade design objectives.~~
- (A) ~~Integrate structures on-site with natural topography;~~
 - (B) ~~Encourage an appropriate transition between new structures on-site with existing structures on abutting sites;~~
 - (C) ~~Promote human scale development;~~
 - (D) ~~Preserve exposure to light, air, and visual access;~~
 - (E) ~~Create visually interesting buildings by integrating structures with landscaping;~~
 - (F) ~~Integrate new structures into the existing neighborhood;~~
 - (G) ~~Promote the relationship of structures with streets;~~
 - (H) ~~Encourage structure siting which creates useable open spaces;~~
 - (I) ~~Encourage the interplay of contrast and compatibility in building siting, including design compatibility between parking facilities and dwelling units;~~
 - (J) ~~Break up building facades through architecturally defined building entryways; and~~
 - (K) ~~Design building rooflines which reinforce the residential character of the building and the surrounding neighborhood.~~
- (b) ~~General siting and building mass.~~
- (1) ~~Design review guidelines.~~
- (A) ~~Buildings shall be sited with sensitivity to topography and natural landform (see Figure 702-9).~~
 - (B) ~~The development shall be designed to reinforce human scale.~~
 - (C) ~~Buildings with long monotonous exterior walls shall be avoided.~~
- (2) ~~Design review standards.~~
- (A) ~~Where the development is located on a lot with an average cross slope of 15 percent or more, do not regrade more than 60 percent of the site surface area.~~
 - (B) ~~Buildings shall have no dimension greater than 150 feet.~~

FIGURE 702-9. BUILDINGS SITED SENSITIVELY IN RELATION TO TOPOGRAPHY

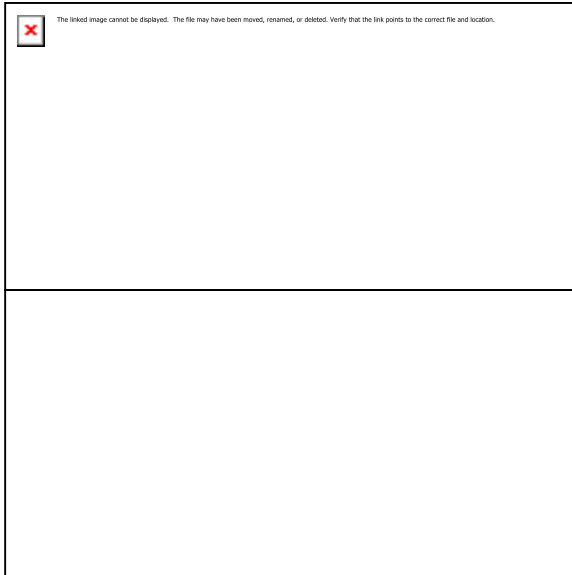

(c) *Compatibility.*

(1) *Design review guidelines.*

- (A) ~~Contrast and compatibility shall be provided throughout the site through building design, size, and location.~~
- (B) ~~Appropriate transitions shall be provided between new buildings and structures on-site and existing buildings and structures on abutting sites.~~
- (C) ~~Architectural elements and facade materials shall be used to provide continuity throughout the site.~~
- (D) ~~The majority of dwelling units within the development shall be placed as close as possible to the street right-of-way.~~
- (E) ~~Architecturally defined and covered entryways shall be incorporated into the design of buildings.~~

(2) *Design review standards.*

- (A) ~~Except as provided in subsection (c)(2)(B) of this section, where a development site abuts property zoned Residential Agricultural (RA) or Single Family Residential (RS), buildings shall be setback from the abutting RA or RS zoned property as set forth in Table 702-4.~~

TABLE 702-4. SETBACKS ABUTTING PROPERTY ZONED RA AND RS

Number of Building Stories	Minimum Setback
1	Min. 1 foot for each 1 foot of building height, but in no case less than 14 ft.
2 or more	Min. 1 foot for each 1 foot of building height, but in no case less than 20 ft.

(B) ~~Where a development site abuts, and is located uphill from, property zoned Residential Agricultural (RA) or Single Family Residential (RS), and the slope of the development site within 40 feet of the abutting RA or RS zoned property is 15 percent or greater, buildings shall be setback from the abutting RA or RS zoned property as set forth in Table 702-5.~~

TABLE 702-5. SETBACKS ABUTTING PROPERTY ZONED RA AND RS

Number of Building Stories	Minimum Setback	Limitation & Qualifications
1 to 2	Min. 1 foot for each 1 foot of building height, but in no case less than 20 ft.	
3 or more	Min. 1 foot for each 1 foot of building height, but in no case less than 40 ft.	
	Min. 1 foot for each 1 foot of building height	<p>Applicable when, within 40 feet of the abutting RA or RS zoned property:</p> <ul style="list-style-type: none"> ■ Buildings are designed so that the longest dimension of the building and any private open space areas, such as balconies or patios, do not face the abutting RA or RS zoned property; or ■ Buildings are designed to contain no more

		<p> — than 6 dwelling units, the lengths of the — buildings facing the abutting RA or RS — zone property are no greater than 70 feet, — and the buildings are separated by a — minimum distance of 1 foot for each — 1 foot of building height. </p>
--	--	---

- ~~(C) On sites with 75 feet or more of buildable width, a minimum of 50 percent of the buildable width shall be occupied by building placed at the setback line. Accessory structures shall not apply towards meeting the required percentage.~~
- ~~(D) Roof-mounted mechanical equipment, other than vents or ventilators, shall be screened from ground level view. Screening shall be as high as the top of the mechanical equipment, and shall be integrated with exterior building design.~~
- ~~(E) A porch or architecturally defined entry area shall be provided for each ground level dwelling unit. Shared porches or entry areas are permitted, provided the porch or entry area has at least 25 square feet of area for each dwelling unit, with no dimension less than five feet. Porches and entry areas shall be open on at least one side, and may be covered or uncovered. All grade level porches shall include hand-railings, half walls, or shrubs to define the outside perimeter.~~

~~(d) *Building articulation.*~~

~~(1) *Design review guidelines.*~~

- ~~(A) The appearance of building bulk shall be minimized by:

 - ~~(i) Establishing a building offset interval along building facades; and~~
 - ~~(ii) Dispersing windows throughout building facades.~~~~
- ~~(B) Articulation shall be provided at the common entryway to all residential buildings.~~
- ~~(C) Building roofs shall reinforce the residential character of the neighborhood.~~

~~(2) *Design review standards.*~~

- ~~(A) Every two attached dwelling units shall be offset from the next dwelling unit by at least four feet in depth (see Figure 702-10).~~
- ~~(B) Within 28 feet of every property line, the building setback for adjacent buildings on the same lot shall vary by at least four feet in depth.~~
- ~~(C) Common entrances shall be provided to not more than four dwelling units.~~

- (D) ~~Individual and common entryways shall be articulated with a differentiated roof, awning, or portico.~~
- (E) ~~Flat roofs, and the roof ridges of sloping roofs, shall not exceed a horizontal length of 100 feet without providing differences in elevation of at least four feet.~~
- (F) ~~Windows shall be provided in all habitable rooms, other than bathrooms, that face required setbacks, common open areas, and parking areas.~~

FIGURE 702-10. BUILDING OFFSETS AND ARTICULATION

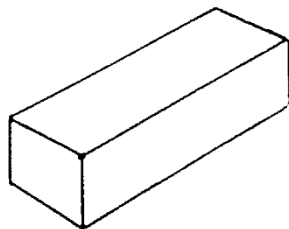
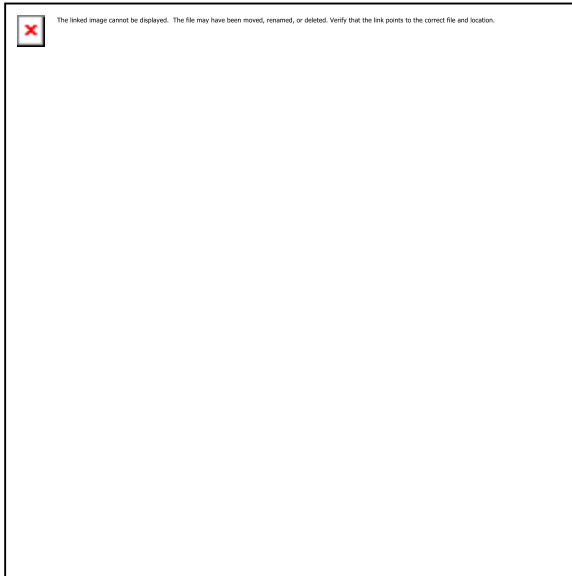

**Undesirable
Architectural Treatment**

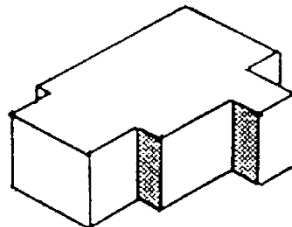

**Horizontal Articulation
Added**

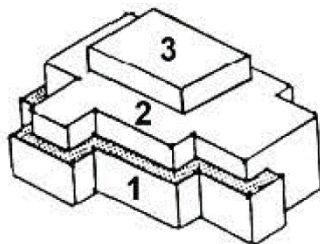

**Vertical Articulation
Added
(1-3 as examples)**

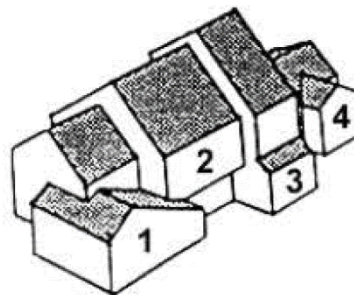

**Multi-Planed Roofs and Awnings Add
Desirable Articulation
(1-4 as examples)**

Sec. 702.040. -- Recycling.

~~(a) -- On-site design and location of facilities.~~

~~(1) -- Design review guidelines.~~

- ~~(A) -- Facilities shall be provided to allow recycling opportunities for tenants that are as conveniently located as the trash receptacles, and that are in compliance with any applicable federal, state, or local laws.~~
- ~~(B) -- The design and materials of recycling areas shall be similar to the design and materials of the buildings within the development.~~
- ~~(C) -- Recycling areas shall be located to provide adequate access for franchised haulers, and shall have containers sufficient to allow collection of all recyclables collected by the haulers.~~

~~(2) -- Design review standards.~~

- ~~(A) -- Recycling areas shall be located, designed, and constructed in conformance with any applicable federal, state, or local laws relating to fire, building, access, transportation, circulation, or safety.~~
- ~~(B) -- Recycling areas shall be protected against environmental conditions, such as rain.~~
- ~~(C) -- Instructions for using recycling containers and how to prepare and separate all the materials collected by franchised haulers shall be clearly posted in recycling areas.~~
- ~~(D) -- Recycling areas shall be provided that are sufficient in capacity, number, distribution, and size to serve the tenants of the development.~~
- ~~(E) -- The design and materials of recycling areas shall be similar to the design and materials of the buildings within the development.~~

CHAPTER 702. - MULTIPLE FAMILY DESIGN REVIEW STANDARDS

Sec. 702.001. - Purpose.

The purpose of this chapter is to establish design review standards for multiple family development.

Sec. 702.005. - Multiple family design review.

(a) Except as provided under subsection (b) of this section, and unless otherwise provided in the UDC, design review under SRC chapter 225 is required for all multiple family development.

(b) Exceptions. Multiple family design review is not required for:

(A) Multiple family development within a mixed-use building.

(B) Multiple family development within:

- (i) The Central Business District (CB) Zone.
- (ii) The South Waterfront Mixed-Use (SWMU) Zone.
- (iii) The Neighborhood Center Mixed-Use (NCMU) Zone.
- (iv) The Broadway/High Street Retail Overlay Zone

- (v) The Broadway/High Street Housing Overlay Zone.
- (vi) The General Retail/Office Overlay Zone.
- (vii) The Front Street Overlay Zone.
- (viii) The Riverfront High Density Residential Overlay Zone.
- (ix) The Riverfront Overlay Zone.
- (x) The Salem Downtown Historic District.
- (xi) The Public and Private Health Services (PH) Zone.
- (xii) The Mixed Use-I (MU-I) Zone.
- (xiii) The Mixed Use-II (MU-II) Zone.
- (xvi) The West Salem Central Business District (WSCB) Zone.

Sec. 702.010. - Multiple family design review standards.

Multiple family development shall comply with all of the applicable design review standards as follows:

- (a) Multiple family development with five to 12 dwelling units shall comply with the design review standards set forth in SRC 702.015 or the design review standards set forth in SRC 702.020.
- (b) Multiple family development with 13 or more dwelling units shall comply with the design review standards set forth in SRC 702.020.
- (c) The design review standards set forth in this chapter are in addition to, and not in lieu of, all other applicable development standards in the UDC. Where the design review standards conflict with the development standards in the UDC, the design review standards shall be the applicable development standard.

Sec. 702.015 Design review standards for multiple family development with five to 12 units

(a) Open space standards

- (1) To encourage the preservation of natural open space qualities that may exist on a site and to provide opportunities for active and passive recreation, all newly constructed multiple family developments shall provide a minimum 20 percent of the gross site area as designated and permanently reserved open space. For the purposes of this subsection, the term "newly constructed multiple family developments" shall not include multiple family developments created through only construction or improvements to the interior of an existing building(s). Indoor or covered recreation space may count toward this open space requirement.
- (A) To ensure usable open space, at least one common open space area shall be provided within the development that is at least 500 square feet in size and has a minimum dimension of 20 feet for all sides.

(B) To allow for a mix of different types of open space areas and flexibility in site design, private open space, meeting the size and dimension standards set forth in Table 702-1, may count toward the open space requirement. All private open space must meet the size and dimension standards set forth in Table 702-1.

TABLE 702-1. PRIVATE OPEN SPACE SIZE AND DIMENSIONS		
Location of Dwelling Unit	Minimum Open Space Area Size	Minimum Dimension
<u>Not more than 5 feet above finished grade</u>	<u>96 sq. ft.</u>	<u>6 ft.</u>
<u>More than 5 feet above finished grade</u>	<u>48 sq. ft.</u>	<u>6 ft.</u>

(C) To encourage active recreational opportunities for residents, the square footage of an improved open space area may be counted twice toward the total amount of required open space, provided each such area meets the standards set forth in this subsection. Example: a 500-square-foot improved open space area may count as 1,000 square feet toward the open space requirement.

- (i) Be a minimum 500 square feet in size with a minimum dimension of 20 feet for all sides; and
- (ii) Include at least one of the following types of features:
 - a. Covered pavilion
 - b. Designated picnic area with benches and at least two picnic tables
 - c. Ornamental or food garden
 - d. Developed and equipped children’s play area, with a minimum 30-inch tall fence to separate the children’s play area from any parking lot, drive aisle, or street
 - e. Sports area or court (e.g., tennis, handball, volleyball, basketball, soccer)
 - f. Swimming pool or wading pool

(D) To encourage proximity to and use of public parks, the total amount of required open space may be reduced by 50 percent for developments that are located within one-quarter mile of a publicly-owned urban, community, or neighborhood park as measured along a route utilizing public or private streets that are existing or will be constructed with the development.

(b) Landscaping standards

- (1) Where a development site abuts property that is zoned Residential Agricultural (RA) or Single Family Residential (RS), a combination of landscaping and screening shall be provided to buffer between the multiple family development and the abutting RA or RS zoned property. The landscaping and screening shall include the following:
 - (A) A minimum of one tree, not less than 1.5 inches in caliper, for every 30 linear feet of abutting property width; and
 - (B) A minimum six-foot tall, decorative, sight-obscuring fence or wall. The fence or wall shall be constructed of materials commonly used in the construction of fences and walls, such as wood, stone, rock, brick, or other durable materials. Chainlink fencing with slats shall be not allowed to satisfy this standard.
- (2) Multiple family developments shall comply with the landscaping standards applicable in the underlying zone in which such developments are located.

(c) Site safety and security

- (1) Windows shall be provided in all habitable rooms, other than bathrooms, on each wall that faces common open space, parking areas, and pedestrian paths to encourage visual surveillance of such areas and minimize the appearance of building bulk.
- (2) Lighting shall be provided that illuminates all exterior dwelling unit entrances, parking areas, and pedestrian paths within the development.

(d) Parking and site design

- (1) To minimize the visual impact of on-site parking and to enhance the pedestrian experience, off-street surface parking areas and vehicle maneuvering areas shall be located behind or beside buildings and structures. Off-street surface parking areas and vehicle maneuvering areas shall not be located between a building or structure and a street.
- (2) To ensure safe pedestrian access to and throughout a development site, pedestrian pathways shall be provided that connect to and between buildings, common open space, and parking areas, and that connect the development to the public sidewalks.

(e) Façade and building design

- (1) Where a development site abuts property zoned Residential Agricultural (RA) or Single Family Residential (RS), buildings shall be setback from the abutting RA or RS zoned property as set forth in Table 702-2 to provide appropriate transitions between new buildings and structures on-site and existing buildings and structures on abutting sites.

TABLE 702-2. SETBACKS ABUTTING PROPERTY ZONED RA AND RS

<u>Building Dimension Adjacent to Property Zoned RA and RS</u>	<u>Number of Building Stories</u>	<u>Minimum Setback</u>
<u>80 feet or less</u>	<u>1 or 2</u>	<u>10 feet</u>
	<u>3 or more</u>	<u>20 feet</u>
<u>Greater than 80 feet</u>	<u>1</u>	<u>Min. 1 foot for each 1 foot of building height, but in no case less than 14 ft.</u>
	<u>2 or more</u>	<u>Min. 1 foot for each 1 foot of building height, but in no case less than 20 ft.</u>

- (A) A 5-foot reduction is permitted to each required setback in Table 702-2 provided that the height of the required fence in Sec. 702.015(b)(1)(B) is increased to eight feet tall.
- (2) On sites with 75 feet or more of buildable width, a minimum of 40 percent of the buildable width shall be occupied by building placed at the setback line to enhance visual interest and activity along the street. Accessory structures shall not apply towards meeting the required percentage.
- (3) To orient buildings to the street, any ground-level unit, cluster of units, or interior lobbies, or portions thereof, located within 25 feet of the property line abutting a street shall have a building entrance facing the street, with direct pedestrian access to the adjacent sidewalk.
- (4) A porch or architecturally defined entry area shall be provided for each ground level dwelling unit. Shared porches or entry areas shall be provided to not more than four dwelling units. Individual and common entryways shall be articulated with a differentiated roof, awning, stoop, forecourt, arcade or portico.
- (5) Roof-mounted mechanical equipment, other than vents or ventilators, shall be screened from ground level view. Screening shall be as high as the top of the mechanical equipment, and shall be integrated with exterior building design.
- (6) To reinforce the residential character of the neighborhood, flat roofs, and the roof ridges of sloping roofs, shall not exceed a horizontal length of 75 feet without providing differences in elevation of at least four feet in height. In lieu of providing differences in elevation, a cross gable or dormer that is a minimum of four feet in length may be provided. (See Figure 702-1)

FIGURE 702-1. MULTIPLE FAMILY ROOFLINE MODULATION OPTIONS

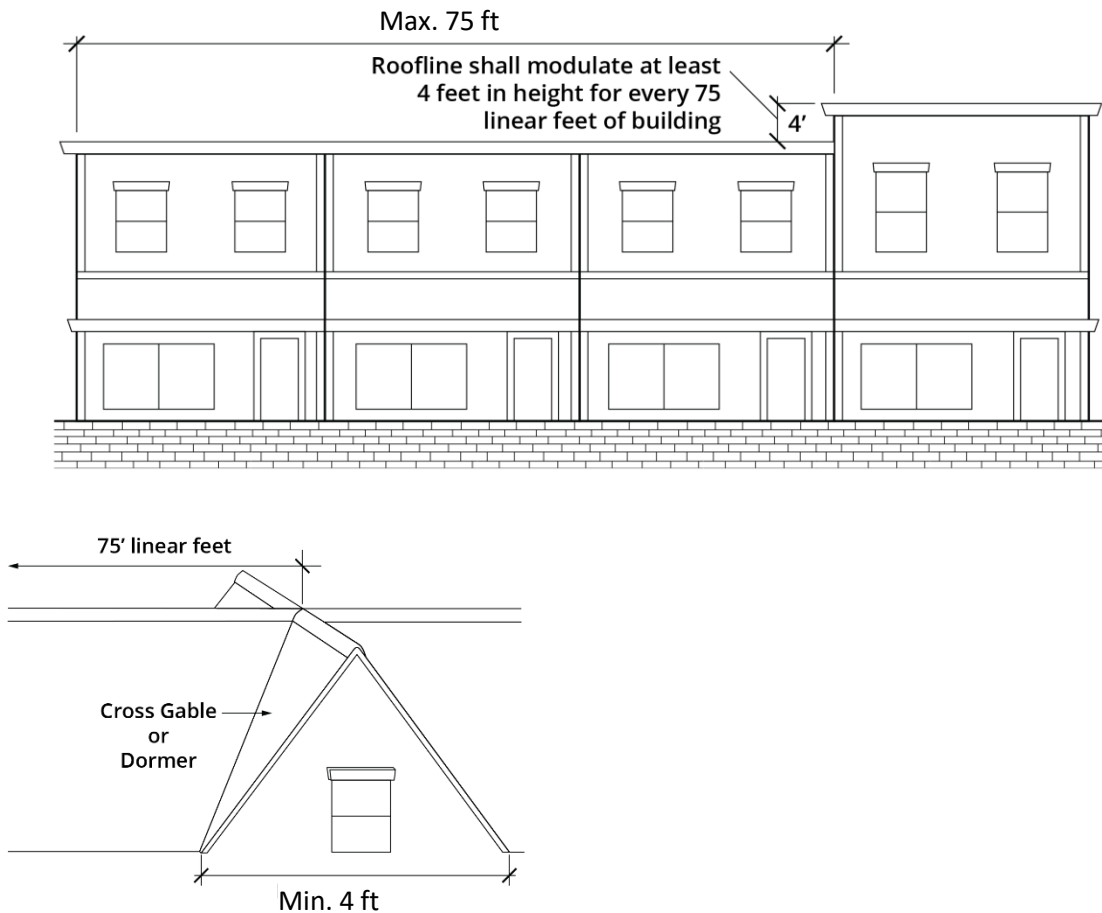

Sec. 702.020 Design review standards for multiple family development with 13 or more units.

(a) Open space standards

(1) To encourage the preservation of natural open qualities that may exist on a site and to provide opportunities for active and passive recreation, all newly constructed multiple family developments shall provide a minimum 30 percent of the gross site area in designated and permanently reserved open space. For the purposes of this subsection, the term "newly constructed multiple family developments" shall not include multiple family developments created through only construction or improvements to the interior of an existing building(s). Indoor or covered recreation space may count toward this open space requirement.

(A) To ensure usable open space that is of sufficient size, at least one common open space area shall be provided that meets the size and dimension standards set forth in Table 702-3.

TABLE 702-3. COMMON OPEN SPACE AREA SIZE AND DIMENSIONS

<u>Number of Dwelling Units</u>	<u>Minimum Open Space Area Size</u>	<u>Minimum Horizontal Dimension</u>
<u>13 to 20</u>	<u>750 sq. ft.</u>	<u>25 ft.</u>
<u>More than 20</u>	<u>1000 sq. ft., plus an additional 250 sq. ft. for every 20 units, or portion thereof, over 20 units.</u>	<u>25 ft.</u>

- (B) To ensure the provided open space is usable, a maximum of 15 percent of the common open space shall be located on land with slopes greater than 25 percent.
- (C) To allow for a mix of different types of open space areas and flexibility in site design, private open space, meeting the size and dimension standards set forth in Table 702-4, may count toward the open space requirement. All private open space must meet the size and dimension standards set forth in Table 702-4.

TABLE 702-4. PRIVATE OPEN SPACE SIZE AND DIMENSIONS

<u>Location of Dwelling Unit</u>	<u>Minimum Open Space Area Size</u>	<u>Minimum Dimension</u>
<u>Not more than 5 feet above finished grade</u>	<u>96 sq. ft.</u>	<u>6 ft.</u>
<u>More than 5 feet above finished grade</u>	<u>48 sq. ft.</u>	<u>6 ft.</u>

- (D) To ensure a mix of private and common open space in larger developments, private open space, meeting the size and dimension standards set forth in Table 702-4, shall be provided for a minimum of 20 percent of the dwelling units in all newly constructed multiple family developments with 20 or more dwelling units. Private open space shall be located contiguous to the dwelling unit, with direct access to the private open space provided through a doorway.
- (E) To encourage active recreational opportunities for residents, the square footage of an improved open space area may be counted twice toward the total amount of required open space, provided each such area meets the standards set forth in this subsection. Example: a 750-square-foot improved open space area may count as 1,500 square feet toward the open space requirement.
- (i) Be a minimum 750 square feet in size with a minimum dimension of 25 feet for all sides; and
- (ii) Include at least one of the following types of features:
- a. Covered pavilion

- b. Picnic area with benches and at least two picnic tables
 - c. Ornamental or food garden
 - d. Developed and equipped children's play area, with a minimum 30-inch tall fence to separate the children's play area from any parking lot, drive aisle, or street
 - e. Sports court (e.g., tennis, handball, volleyball)
 - f. Swimming pool or wading pool
- (F) To encourage proximity to and use of public parks, the total amount of required open space may be reduced by 50 percent for developments that are located within one-quarter mile of a public urban, community, or neighborhood park as measured along a route utilizing public or private streets that are existing or will be constructed with the development.

(b) Landscaping standards

- (1) To encourage the preservation of trees and maintain or increase tree canopy, a minimum of one tree shall be planted or preserved for every 2,000 square feet of gross site area.
- (2) Where a development site abuts property that is zoned Residential Agricultural (RA) or Single Family Residential (RS), a combination of landscaping and screening shall be provided to buffer between the multiple family development and the abutting RA or RS zoned property. The landscaping and screening shall include the following:
 - (A) A minimum of one tree, not less than 1.5 inches in caliper, for every 30 linear feet of abutting property width; and
 - (B) A minimum six-foot tall, decorative, sight-obscuring fence or wall. The fence or wall shall be constructed of materials commonly used in the construction of fences and walls, such as wood, stone, rock, brick, or other durable materials. Chainlink fencing with slats shall be not allowed to satisfy this standard.
- (3) To define and accentuate primary entryways, a minimum of two plant units, shall be provided adjacent to the primary entryway of each dwelling unit, or combination of dwelling units.
- (4) To soften the visual impact of buildings and create residential character, new trees shall be planted, or existing trees shall be preserved, at a minimum density of ten plant units per 60 linear feet of exterior building wall. Such trees shall be located not more than 25 feet from the edge of the building footprint.

(5) Shrubs shall be distributed around the perimeter of buildings at a minimum density of one plant unit per 15 linear feet of exterior building wall.

(6) To ensure the privacy of dwelling units, ground level private open space shall be physically and visually separated from common open space with perimeter landscaping or perimeter fencing.

FIGURE 702-2. SEPARATION OF PRIVATE AND COMMON OPEN SPACE

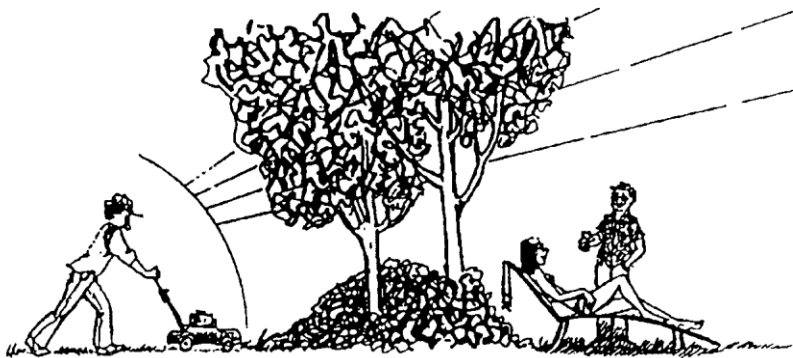
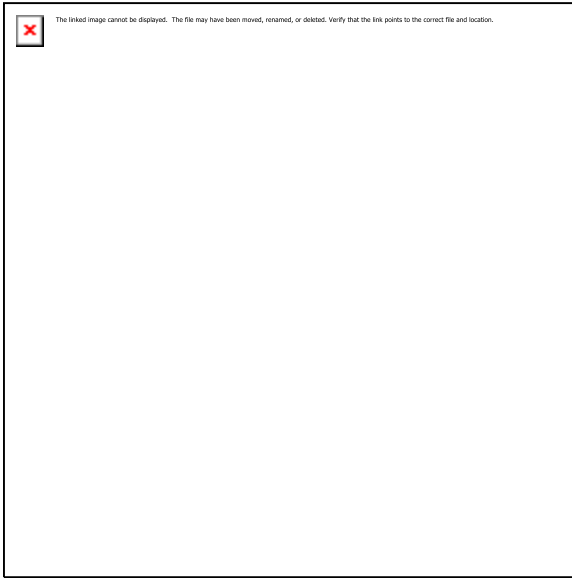

(7) To provide protection from winter wind and summer sun and to ensure trees are distributed throughout a site and along parking areas, a minimum of one canopy tree shall be planted along every 50 feet of the perimeter of parking areas. Trunks of the trees shall be located within 10 feet of the edge of the parking area (see Figure 702-3).

(A) A minimum of one canopy tree shall be planted within each planter bay.

(B) A landscaped planter bay a minimum of 9 feet in width shall be provided at a minimum spacing of one for every 12 spaces. (see Figure 702-3).

FIGURE 702-3. CONCEPTUAL PARKING AREA LAYOUT

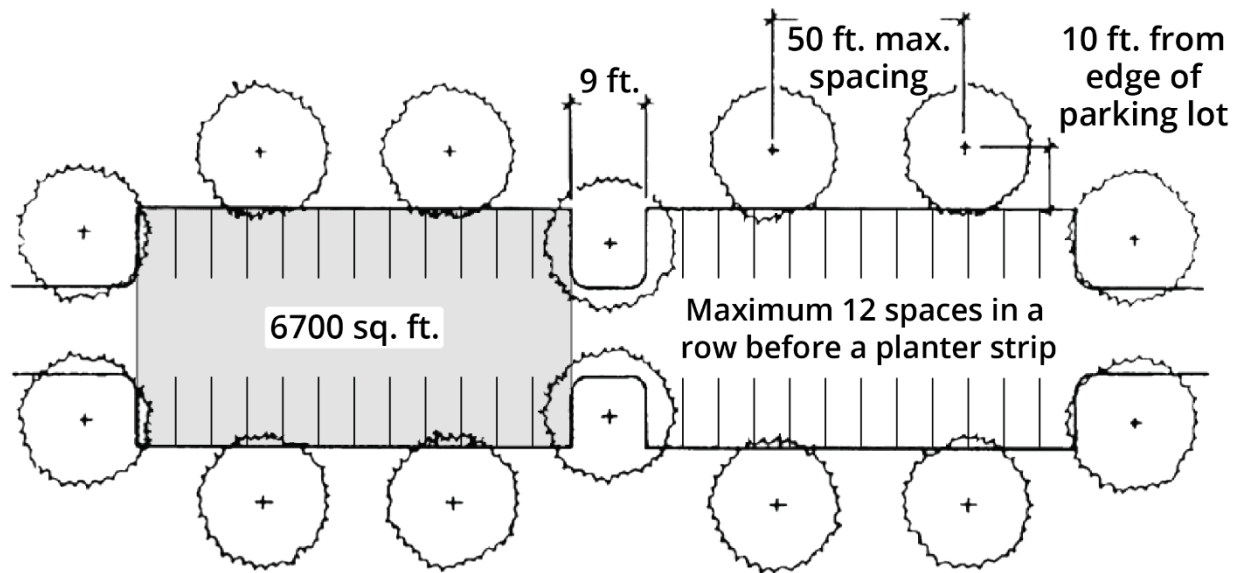

(8) Multiple family developments with 13 or more units are exempt from the landscaping requirements in SRC chapter 806.

(c) Site safety and security

- (1) Windows shall be provided in all habitable rooms, other than bathrooms, on each wall that faces common open space, parking areas, and pedestrian paths to encourage visual surveillance of such areas and minimize the appearance of building bulk.
- (2) Lighting shall be provided that illuminates all exterior dwelling unit entrances, parking areas, and pedestrian paths within the development to enhance visibility and resident safety.
- (3) Fences, walls, and plant materials shall not be installed between street-facing dwelling units and public or private streets in locations that obstruct the visibility of dwelling unit entrances from the street. For purposes of this standard, the term "obstructed visibility" means the entry is not in view from the street along one-half or more of the dwelling unit's frontage.
- (4) Landscaping and fencing adjacent to common open space, parking areas, and dwelling unit entryways shall be limited to a maximum height of three feet to encourage visual surveillance of such areas.

(d) Parking and site design

- (1) To minimize large expanses of continuous pavement, parking areas greater than 6,700 square feet in area shall be physically and visually separated with landscaped planter

bays that are a minimum of 9 feet in width. Individual parking areas may be connected by an aisle or driveway (see Figure 702-3).

(2) To minimize the visual impact of on-site parking and to enhance the pedestrian experience, off-street surface parking areas and vehicle maneuvering areas shall be located behind or beside buildings and structures. Off-street surface parking areas and vehicle maneuvering areas shall not be located between a building or structure and a street.

(3) Where a development site abuts, and is located uphill from, property zoned Residential Agriculture (RA) or Single Family Residential (RS), and the slope of the development site within 40 feet of the abutting RA or RS zoned property is 15 percent or greater, parking areas shall be set back not less than 20 feet from the property line of the abutting RA or RS zoned property to ensure parking areas are designed to consider site topography and minimize visual impacts on abutting residential properties.

(4) To ensure safe pedestrian access to and throughout a development site, pedestrian pathways shall be provided that connect to and between buildings, common open space, and parking areas, and that connect the development to the public sidewalks.

(e) Façade and building design

(1) To preclude long monotonous exterior walls, buildings shall have no dimension greater than 150 feet.

(2) Where a development site abuts property zoned Residential Agricultural (RA) or Single Family Residential (RS), buildings shall be setback from the abutting RA or RS zoned property as set forth in Table 702-5 to provide appropriate transitions between new buildings and structures on site and existing buildings and structures on abutting sites.

TABLE 702-5. SETBACKS ABUTTING PROPERTY ZONED RA AND RS	
Number of Building Stories	Minimum Setback
<u>1</u>	<u>Min. 1 foot for each 1 foot of building height, but in no case less than 14 ft.</u>
<u>2 or more</u>	<u>Min. 1 foot for each 1 foot of building height, but in no case less than 20 ft.</u>

(A) A 5-foot reduction is permitted to each required setback in Table 702-5 provided that the height of the required fence in Sec. 702.020(b)(2)(B) is increased to eight feet tall.

- (3) To enhance compatibility between new buildings on site and abutting residential sites, balconies shall not be located on building facades that face properties that are zoned RA or RS, unless separated by a street.
- (4) On sites with 75 feet or more of buildable width, a minimum of 40 percent of the buildable width shall be occupied by building placed at the setback line to enhance visual interest and activity along the street. Accessory structures shall not apply towards meeting the required percentage.
- (5) To orient buildings to the street, any ground-level unit, cluster of units, interior lobbies, or portions thereof, located within 25 feet of the property line abutting a street shall have a building entrance facing that street, with direct pedestrian access to adjacent sidewalks.
- (6) A porch or architecturally defined entry area shall be provided for each ground level dwelling unit. Shared porches or entry areas shall be provided to not more than four dwelling units. Individual and common entryways shall be articulated with a differentiated roof, awning, stoop, forecourt, arcade or portico.
- (7) Roof-mounted mechanical equipment, other than vents or ventilators, shall be screened from ground level view. Screening shall be as high as the top of the mechanical equipment, and shall be integrated with exterior building design.
- (8) To reinforce the residential character of the neighborhood, flat roofs, and the roof ridges of sloping roofs, shall not exceed a horizontal length of 100 feet without providing differences in elevation of at least four feet in height. In lieu of providing differences in elevation, a cross gable or dormer that is a minimum of four feet in length may be provided. (See Figure 702-4)

FIGURE 702-4. MULTIPLE FAMILY ROOFLINE MODULATION OPTIONS

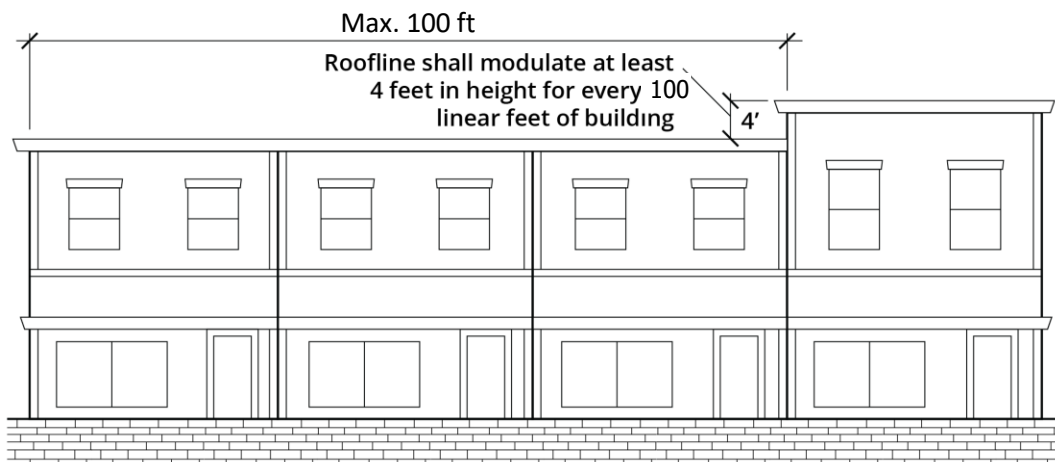

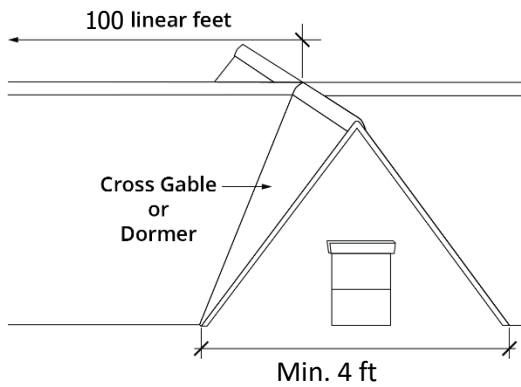

(9) To minimize the appearance of building bulk, each floor of each building's vertical face that is 80 feet in length or longer shall incorporate one or more of the design elements below (see examples in Figure 702-5). Design elements shall vary from other wall surfaces by a minimum of four feet and such changes in plane shall have a minimum width of six feet.

- (A) Offsets (recesses and extensions)
- (B) Covered deck
- (C) Covered balcony
- (D) Cantilevered balcony, provided at least half of its depth is recessed
- (E) Covered entrance

FIGURE 702-5. EXAMPLE OF DESIGN ELEMENTS FOR ARTICULATION





(10) To visually break up the building's vertical mass, the first floor of each building, except for single-story buildings, shall be distinguished from its upper floors by at least one of the following (see examples in Figure 702-6):

- (A) Change in materials
- (B) Change in color
- (C) Molding or other horizontally-distinguishing transition piece

FIGURE 702-6. EXAMPLE OF DESIGN ELEMENTS FOR ARTICULATION



Sec. 800.055. - Solid waste service areas.

Solid waste service areas shall provide for the safe and convenient collection of solid waste and recyclable and compostable materials by the local solid waste collection franchisee.

(a) *Applicability.* Solid waste service area design standards shall apply to:

- (1) All new solid waste, recycling, and compostable service areas, where use of a solid waste, recycling, and compostable receptacle of one cubic yard or larger is proposed; and

- (2) Any change to an existing solid waste service area for receptacles of one cubic yard or larger that requires a building permit.
- (b) *Solid waste receptacle placement standards.* All solid waste receptacles shall be placed at grade on a concrete pad that is a minimum of four inches thick, or on an asphalt pad that is a minimum of six inches thick. The pad shall have a slope of no more than a three percent and shall be designed to discharge stormwater runoff consistent with the overall stormwater management plan for the site approved by the Director.
- (1) *Pad area.* In determining the total concrete pad area for any solid waste service area:
- (A) The pad area shall extend a minimum of one foot beyond the sides and rear of the receptacle; and
 - (B) The pad area shall extend a minimum three feet beyond the front of the receptacle.
 - (C) In situations where receptacles face each other, a minimum four feet of pad area shall be required between the fronts of the facing receptacles.
- (2) *Minimum separation.*
- (A) A minimum separation of 1.5 feet shall be provided between the receptacle and the side wall of the enclosure.
 - (B) A minimum separation of five feet shall be provided between the receptacle and any combustible walls, combustible roof eave lines, or building or structure openings.
- (3) *Vertical clearance.*
- (A) Receptacles two cubic yards or less. Receptacles two cubic yards or less in size shall be provided with a minimum of eight feet of unobstructed overhead or vertical clearance for servicing.
 - (B) Receptacles greater than two cubic yards. Receptacles greater than two cubic yards in size shall be provided with a minimum of 14 feet of unobstructed overhead or vertical clearance for servicing; provided, however, overhead or vertical clearance may be reduced to eight feet:
 - (i) For enclosures covered by partial roofs, where the partial roof over the enclosure does not cover more than the rear eight feet of the enclosure, as measured from the inside of the rear wall of the enclosure (see Figure 800-6); or
 - (ii) Where a physical barrier is installed within, and a maximum of eight feet from the front opening of, the enclosure preventing the backward movement of the receptacle (see figure 800-7).

FIGURE 800-6 REDUCED OVERHEAD OR VERTICAL CLEARANCE FOR PARTIALLY ROOFED ENCLOSURES

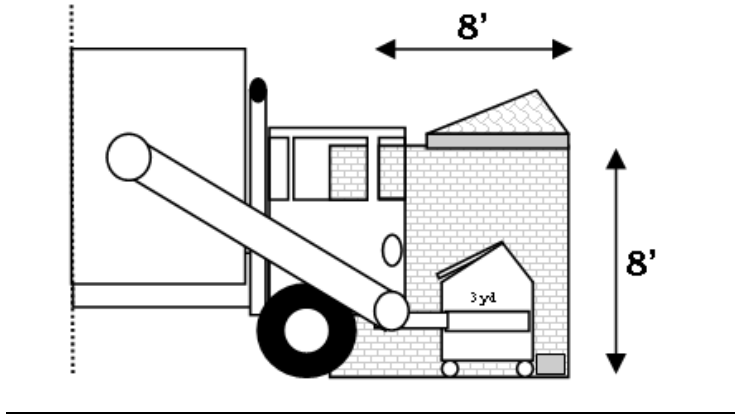
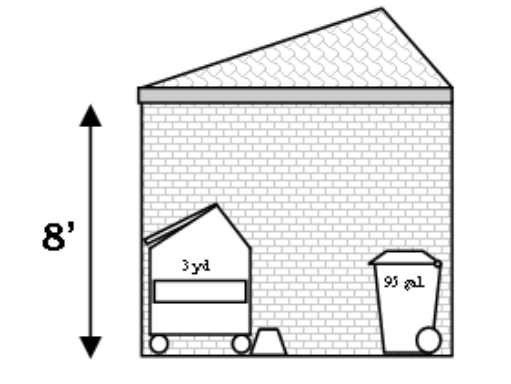

FIGURE 800-7 REDUCED OVERHEAD OR VERTICAL CLEARANCE FOR ENCLOSURES WITH INTERNAL PHYSICAL BARRIER



(c) *Permanent drop box and compactor placement standards.*

- (1) All permanent drop boxes shall be placed on a concrete pad that is a minimum of six inches thick. The pad shall have a slope of no more than one percent and shall be designed to discharge stormwater runoff consistent with the overall stormwater management plan for the site approved by the Director.
- (2) All permanent compactors shall be placed on a concrete pad that is structurally engineered or in compliance with the manufacturer specifications. The pad shall have a slope of no more than three percent and shall be designed to discharge stormwater runoff consistent with the overall stormwater management plan for the site approved by the Director.
- (3) Pad area. The pad area shall be a minimum of 12 feet in width. The pad area shall extend a minimum of five feet beyond the rear of the permanent drop box or compactor.
- (4) Minimum separation. A minimum separation of five feet shall be provided between the permanent drop box or compactor and any combustible walls, combustible roof eave lines, or building or structure openings.

(d) *Solid waste service area screening standards.*

- (1) Solid waste, recycling, and compostable service areas shall be screened from all streets abutting the property and from all abutting residentially zoned property by a

minimum six-foot-tall sight-obscuring fence or wall; provided, however, where receptacles, drop boxes, and compactors are located within an enclosure, screening is not required. For the purpose of this standard, abutting property shall also include any residentially zoned property located across an alley from the property.

- (2) Existing screening at the property line shall satisfy screening requirements if it includes a six-foot-tall sight-obscuring fence or wall.
- (e) *Solid waste service area enclosure standards.* When enclosures are used for required screening or aesthetics, such enclosures shall conform to the ~~following standards set forth in this subsection-~~ The overall dimensions of an enclosure are dependent upon the number and size of receptacles the enclosure is designed to accommodate.
- (1) *Front opening of enclosure.* The front opening of the enclosure shall be unobstructed and shall be a minimum of 12 feet in width.
 - (2) *Measures to prevent damage to enclosure.*
 - (A) Enclosures constructed of wood or chainlink fencing material shall contain a minimum four-inch nominal high bumper curb at ground level located 12 inches inside the perimeter of the outside walls of the enclosure to prevent damage from receptacle impacts.
 - (B) Enclosures constructed of concrete, brick, masonry block, or similar types of material shall contain a minimum four-inch nominal high bumper curb at ground level located 12 inches inside the perimeter of the outside walls of the enclosure, or a fixed bumper rail to prevent damage from receptacle impacts.
 - (C) The requirements under subsections (e)(2)(A) and (B) of this section shall not apply if the enclosure is designed to be separated:
 - (i) A minimum distance of two feet from the sides of the container or receptacles; and
 - (ii) A minimum of three feet from the rear of the container or receptacles.
 - (3) *Enclosure gates.* Any gate across the front opening of an enclosure shall swing freely without obstructions. For any enclosure opening with an unobstructed width of that is less than 15 feet in width, the gates shall open a minimum of 120 degrees. For any enclosure opening with an unobstructed width of that is 15 feet or greater in width, the gates shall open a minimum of 90 degrees. All gates shall have restrainers in the open and closed positions.
 - (4) *Prohibited enclosures.* Receptacles shall not be stored in buildings or entirely enclosed structures unless the receptacles are:
 - (A) Stored in areas protected by an automatic sprinkler system approved by the City Fire Marshal; or
 - (B) Stored in a building or structure of a fire resistive Type I or Type IIA construction that is located not less than ten feet from other buildings and used exclusively for solid waste receptacle storage.
- (f) *Solid waste service area vehicle access.*
- (1) Vehicle operation area.
 - (A) A vehicle operation area shall be provided for solid waste collection service vehicles that is free of obstructions and no less than 45 feet in length and 42

15 feet in width; provided, however, where the front opening of an enclosure is wider than 15 feet, the width of the vehicle operation area shall be increased to equal the width of the front opening of the enclosure. Vehicle operation areas shall be made available in-perpendicular to the front of every receptacle, or, in the case of multiple receptacles within an enclosure, in-perpendicular to front of every enclosure opening.

- (B) For solid waste service areas having receptacles of two cubic yards or less, the vehicle operation area may be located:
- (i) Perpendicular Directly in front of the to the permanent location of the receptacle or the enclosure opening (see Figure 800-8); or
 - (ii) Parallel to the permanent location of the receptacle or the enclosure opening (see Figure 800-9); or
 - ~~(ii)~~ (iii) In a location where the receptacle can be safely maneuvered manually not more than 45 feet into a position at one end of the vehicle operation area for receptacle servicing.

FIGURE 800-8. VEHICLE OPERATION AREA PERPENDICULAR TO FRONT OF ENCLOSURE

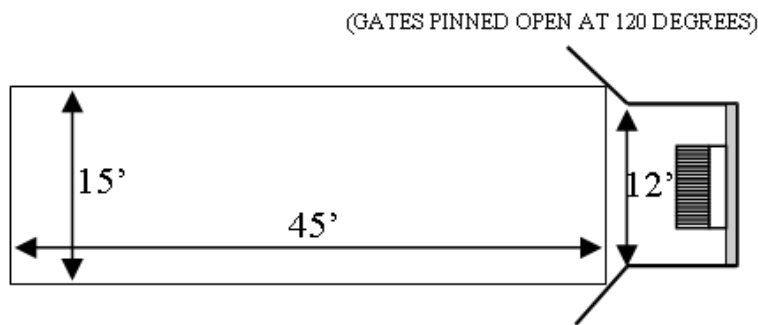
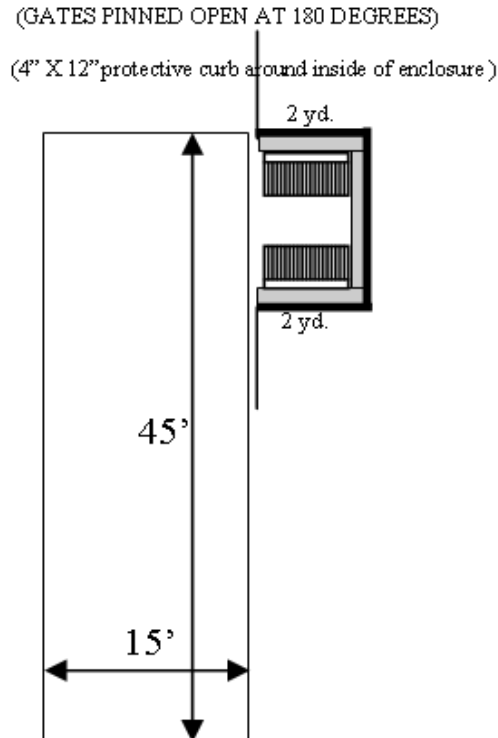
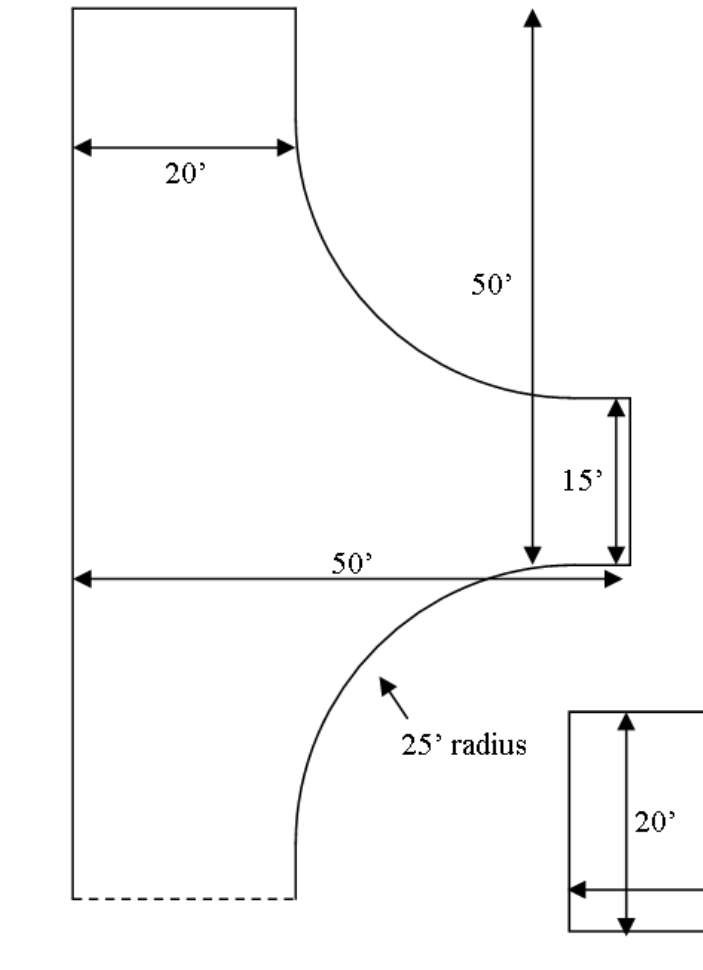

FIGURE 800-9. VEHICLE OPERATION AREA PARALLEL TO FRONT OF ENCLOSURE



- (C) The vehicle operation area may be coincident with a parking lot drive aisle, or driveway, or alley provided that such area is kept free of parked vehicles and other obstructions at all times except for the normal ingress and egress of vehicles.
- (D) Vertical clearance. Vehicle operation areas shall have a minimum vertical clearance of 14 feet.
- (D)(E) In the event that access to the vehicle operation area is not a direct approach into position for operation of the service vehicle, a turnaround, in conformance with the minimum dimension and turning radius requirements shown in Figure 800-10 designed and constructed pursuant to the Public Works Design Standards, shall be required to allow safe and convenient access for collection service.

FIGURE 800-10. VEHICLE OPERATION AREA PARALLEL TO FRONT OF ENCLOSURE



- (2) Vehicle operation areas shall be designed so that waste collection service vehicles are not required to back onto a public street or leave the premises.
- (3) Vehicle operation areas shall be paved with asphalt, concrete, or other hard surfacing approved by the Director, and shall be adequately designed, graded, and drained to the approval of the Director.
- (4) Signs. "No Parking" signs shall be placed in a prominent location on the enclosure, or painted on the pavement in front of the enclosure or receptacle, to ensure unobstructed and safe access for the servicing of receptacles.
- (g) *Notice to solid waste collection franchisee.* Upon receipt of an application to vary or adjust the standards set forth in this section, notification and opportunity to comment shall be provided to the applicable solid waste collection franchisee. Notice required under this subsection shall be in addition to the notification required for a variance or adjustment under SRC chapter 300.

Sec. 800.065. - Pedestrian access.

Except where pedestrian access standards are provided elsewhere under the UDC, all developments, other than single family, two family, three family, four family, and multiple

family developments, shall include an on-site pedestrian circulation system developed in conformance with the standards in this section.

(a) *Pedestrian connections required.* The on-site pedestrian circulation system shall provide pedestrian connectivity throughout the development site as follows:

(1) *Connection between building entrances and streets.*

(A) A pedestrian connection shall be provided between the primary building entrance of each building on the development site and each adjacent street. Where a building has more than one primary building entrance, a single pedestrian connection from one of the building's primary entrances to each adjacent street is allowed; provided each of the building's primary entrances are connected, via a pedestrian connection, to the required connection to the street (see Figure 800-116).

(B) Where an adjacent street is a transit route and there is an existing or planned transit stop along street frontage of the development site, at least one of the required pedestrian connections shall connect to the street within 20 feet of the transit stop (see Figure 800-127).

FIGURE 800-116. PEDESTRIAN CONNECTIONS BETWEEN BUILDING ENTRANCES AND STREET

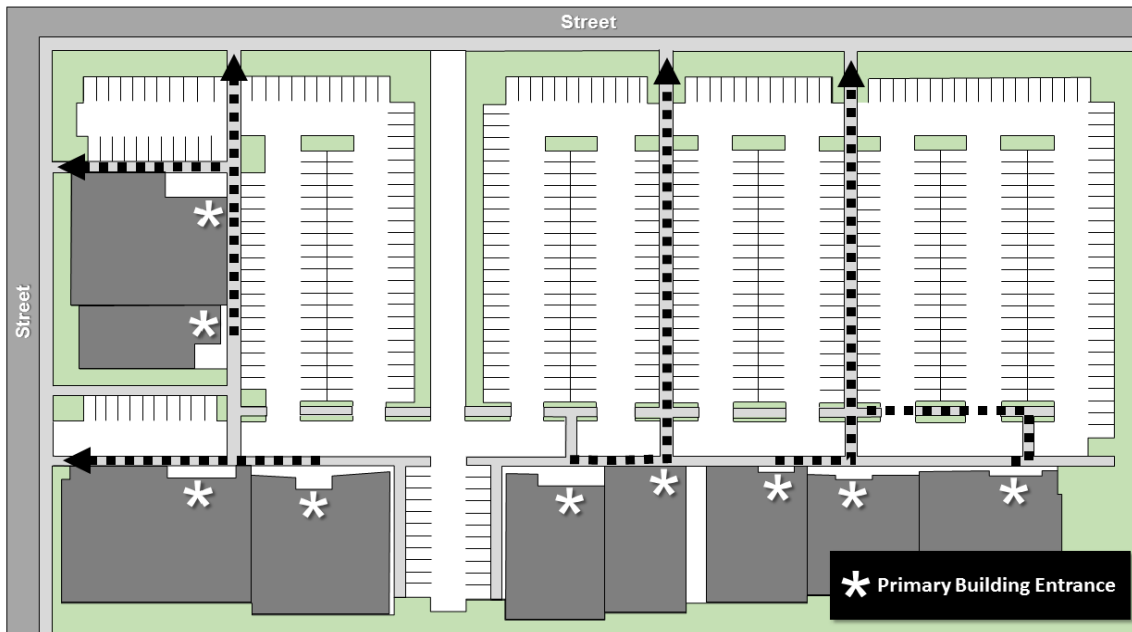
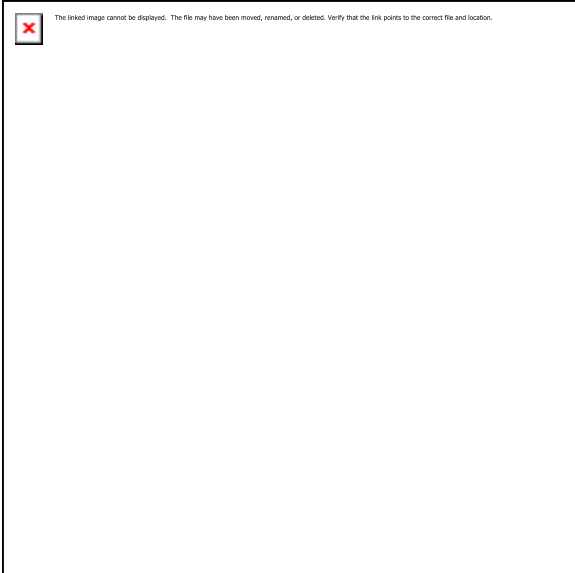
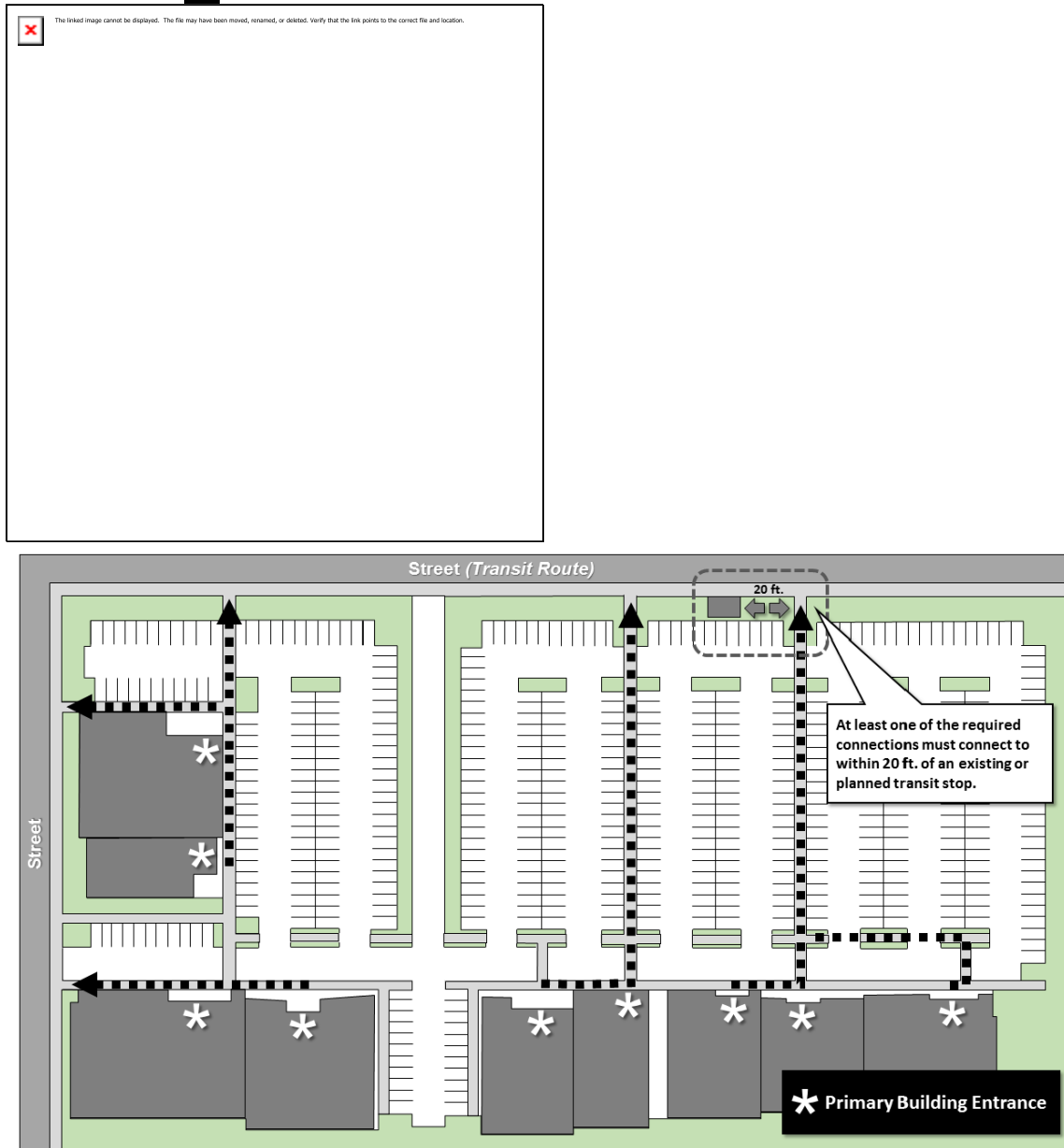

FIGURE 800-127. PEDESTRIAN CONNECTIONS ABUTTING TRANSIT ROUTE



- (2) *Connection between buildings on the same development site.* Where there is more than one building on a development site, a pedestrian connection, or pedestrian connections, shall be provided to connect the primary building entrances of all of the buildings.
- (3) *Connection through off-street parking areas.*
 - (A) Surface parking areas. Except as provided under subsection (a)(3)(A)(iii) of this section, off-street surface parking areas greater than 25,000 square feet in size or including four or more consecutive parallel drive aisles shall include pedestrian connections through the parking area to the primary building entrance as provided in this subsection.

- (i) The pedestrian connections shall be:
 - (aa) ~~Shall be p~~Provided in a minimum amount of either one connection for every four drive aisles or one connection for every 250 feet (See Figure 800-~~138~~); provided, however, in no case shall less than one pedestrian connection be provided. Where the pedestrian connection requirements of this subsection result in a fractional number, any fractional number greater than 0.5 shall be round up to require an additional pedestrian connection;
 - (bb) ~~Shall be s~~Spaced a minimum of two drive aisles apart; and
 - (cc) ~~Shall connect~~Connected to a pedestrian connection, or pedestrian connections, that lead to the primary building entrance.
- (ii) A pedestrian connection provided between a primary building entrance and a street may be counted as a required connection through an off-street surface parking area.
- (iii) Regardless of the size of the off-street parking area, pedestrian connections are not required through off-street surface parking areas that have a depth, in all locations, of not more than 124 feet. For purposes of this subsection, parking area depth is measured through the parking area from its outside edge towards the building.
- (iv) For purposes of this subsection, off-street surface parking area means:
 - (aa) An off-street surface parking area that is separated from other off-street surface parking areas on the development site by either a driveway, which begins at the street and extends into the site, or other physical separation; or
 - (bb) An off-street surface parking area located in a separate location on the development site from other off-street surface parking areas.

FIGURE 800-~~138~~. PEDESTRIAN CONNECTIONS THROUGH OFF-STREET PARKING AREAS

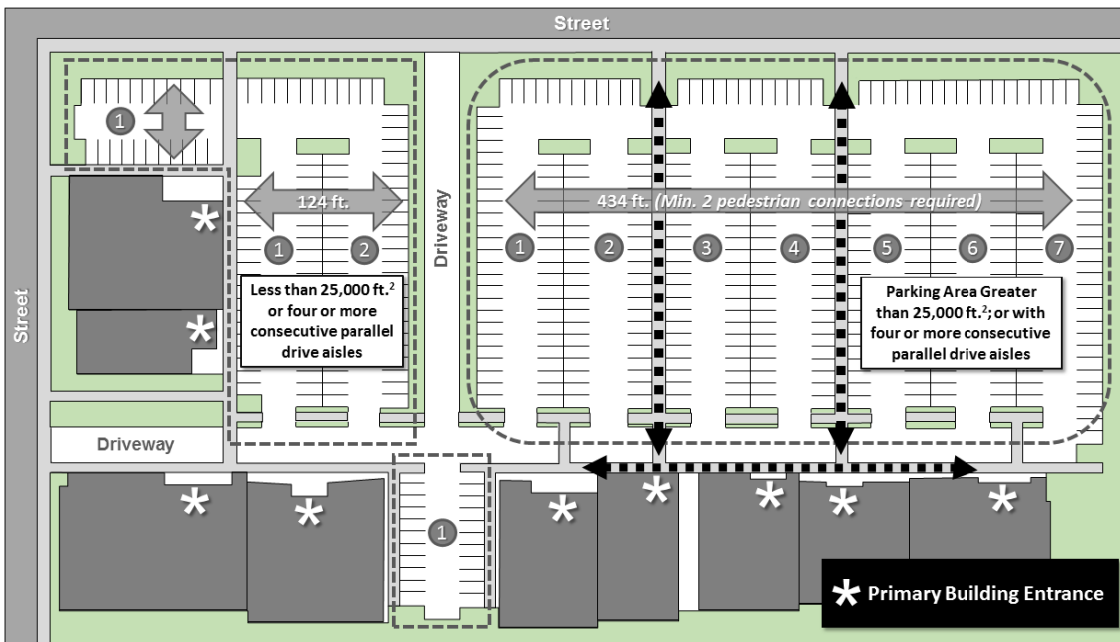
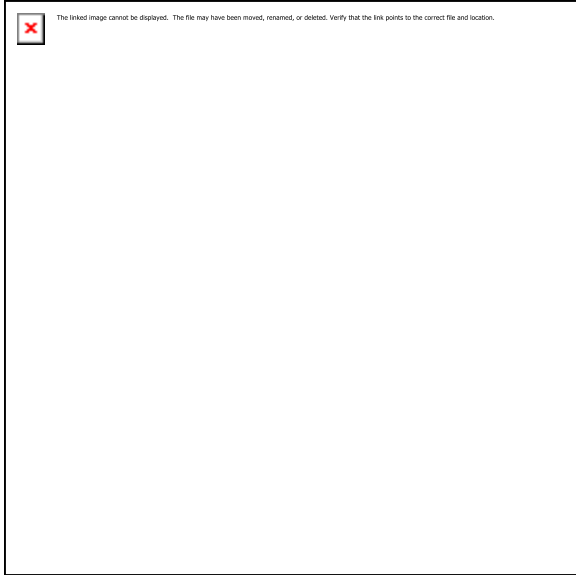

- (B) Parking structures and parking garages. Where an individual floor of a parking structure or parking garage exceeds 25,000 square feet in size, a pedestrian connection shall be provided through the parking area on that floor to an entrance/exit.
- (4) *Connection to existing or planned paths and trails.* Where an existing or planned path or trail identified in the Salem Transportation System Plan (TSP) or the Salem Comprehensive Parks System Master Plan passes through a development site, the path or trail shall:
 - (A) Be constructed, and a public access easement or dedication provided; or

- (B) When no abutting section of the trail or path has been constructed on adjacent property, a public access easement or dedication shall be provided for future construction of the path or trail.
- (5) *Connection to abutting properties.* Whenever a vehicular connection is provided from a development site to an abutting property, a pedestrian connection shall also be provided. A pedestrian connection is not required, however:
- (A) To abutting properties used for activities falling within the following use classifications, use categories, and uses under SRC Chapter 400:
 - (i) Single family;
 - (ii) Two family;
 - (iii) Group living;
 - (iv) Industrial;
 - (v) Infrastructure and utilities; and
 - (vi) Natural resources.
 - (B) Where the use of an abutting property has specific security needs that make providing a connection impractical or undesirable;
 - (C) Where on-site activities on abutting properties, such as the operation of trucks, forklifts, and other equipment and machinery would present safety conflicts with pedestrians;
 - (D) Where buildings or other improvements on abutting properties physically preclude a connection now or in the future; or
 - (E) Where physical conditions of the land, such as topography or existing natural resource areas, including, but not limited to, wetlands, ponds, lakes, streams, or rivers, make providing a connection impractical.
- (b) *Design and materials.* Required pedestrian connections shall be in the form of a walkway, or may be in the form of a plaza.
- (1) Walkways shall conform to the following:
- (A) Material and width. Walkways shall be paved with a hard-surface material meeting the Public Works Design Standards, and shall be a minimum of five feet in width.
 - (B) Where a walkway crosses driveways, parking areas, parking lot drive aisles, and loading areas, the walkway shall be visually differentiated from such areas through the use of elevation changes, a physical separation, speed bumps, a different paving material, or other similar method. Striping does not meet this requirement, except when used in a parking structure or parking garage.
 - (C) Where a walkway is located adjacent to an auto travel lane, the walkway shall be raised above the auto travel lane or separated from it by a raised curb, bollards, landscaping or other physical separation. If the walkway is raised above the auto travel lane it must be raised a minimum of four inches in height and the ends of the raised portions must be equipped with curb ramps. If the walkway is separated from the auto travel lane with bollards, bollard spacing must be no further than five feet on center.

- (2) Wheel stops or extended curbs shall be provided along required pedestrian connections to prevent the encroachment of vehicles onto pedestrian connections.
- (c) *Lighting.* The on-site pedestrian circulation system shall be lighted to a level where the system can be used at night by employees, customers, and residents.

Sec. 804.020. - Class 1. Driveway approach permit.

- (a) *Required.* A Class 1 driveway approach permit is required for:
 - (1) A driveway approach onto a local or collector street providing access to a single family, ~~or two family,~~ three family, or four family use.
 - (2) A driveway approach for any land-locked lot or parcel providing access onto a local or collector street, unless the driveway is part of an existing shared access.
 - (3) A driveway approach providing access to a corner lot that abuts only local or collector streets, where the driveway approach will provide access onto the street with the lower street classification.
 - (4) Maintenance, repair, or replacement of an existing permitted driveway approach, other than maintenance, repair, or replacement that is part of, or needed for, redevelopment of commercial or industrially zoned property.
- (b) *Procedure type.* A Class 1 driveway approach permit is processed as a Type I procedure under SRC chapter 300.
- (c) *Submittal requirements.* In lieu of the application submittal requirements under SRC chapter 300, an application for a Class 1 driveway approach permit shall include the following:
 - (1) A completed application form.
 - (2) A site plan, of a size and form and in the number of copies meeting the standards established by the Director, containing the following information:
 - (A) The location and dimensions of the proposed driveway approach;
 - (B) The relationship to nearest street intersection and adjacent driveway approaches;
 - (C) The location of all utilities;
 - (D) The location of any existing or proposed buildings, structures, or vehicular use areas;
 - (E) The location of any trees and vegetation adjacent to the location of the proposed driveway approach that are required to be protected pursuant to SRC chapter 808; and
 - (F) The location of any street trees adjacent to the location of the proposed driveway approach.
 - (3) Identification of the uses or activities served, or proposed to be served, by the driveway approach.
 - (4) Any other information, as determined by the Director, which may be required to adequately review and analyze the proposed driveway approach for conformance with the applicable criteria.

- (d) *Criteria.* A Class 1 driveway approach permit shall be granted if the proposed driveway approach meets the standards of this chapter and the Public Works Design Standards.

Sec. 804.025. - Class 2 driveway approach permit.

- (a) *Required.* A Class 2 driveway approach permit is required for:
- (1) A driveway approach onto a parkway, major arterial, or minor arterial;
 - (2) A driveway approach onto a local or collector street providing access to a use other than single family, ~~or two family~~, three family, or four family;
 - (3) A driveway approach providing access to a corner lot that abuts only local or collector streets, where the driveway approach will provide access onto the street with the higher street classification; or
 - (4) Maintenance, repair, or replacement of an existing permitted driveway approach, which is part of, or needed for, redevelopment of commercial or industrially zoned property.
- (b) *Procedure type.* A Class 2 driveway approach permit is processed as a Type II procedure under SRC chapter 300.
- (c) *Submittal requirements.* In lieu of the application submittal requirements under SRC chapter 300, an application for a Class 2 driveway approach permit shall include the following:
- (1) A completed application form.
 - (2) A site plan, of a size and form and in the number of copies meeting the standards established by the Director, containing the following information:
 - (A) The location and dimensions of the proposed driveway approach;
 - (B) The relationship to nearest street intersection and adjacent driveway approaches;
 - (C) Topographic conditions;
 - (D) The location of all utilities;
 - (E) The location of any existing or proposed buildings, structures, or vehicular use areas;
 - (F) The location of any trees and vegetation adjacent to the location of the proposed driveway approach that are required to be protected pursuant to SRC chapter 808; and
 - (G) The location of any street trees adjacent to the location of the proposed driveway approach.
 - (3) Identification of the uses or activities served, or proposed to be served, by the driveway approach.
 - (4) Any other information, as determined by the Director, which may be required to adequately review and analyze the proposed driveway approach for conformance with the applicable criteria.
- (d) *Criteria.* A Class 2 driveway approach permit shall be granted if:
- (1) The proposed driveway approach meets the standards of this chapter and the Public Works Design Standards;

- (2) No site conditions prevent placing the driveway approach in the required location;
- (3) The number of driveway approaches onto an arterial are minimized;
- (4) The proposed driveway approach, where possible:
 - (A) Is shared with an adjacent property; or
 - (B) Takes access from the lowest classification of street abutting the property;
- (5) The proposed driveway approach meets vision clearance standards;
- (6) The proposed driveway approach does not create traffic hazards and provides for safe turning movements and access;
- (7) The proposed driveway approach does not result in significant adverse impacts to the vicinity;
- (8) The proposed driveway approach minimizes impact to the functionality of adjacent streets and intersections; and
- (9) The proposed driveway approach balances the adverse impacts to residentially zoned property and the functionality of adjacent streets.

Sec. 804.030. - Access onto local and collector streets.

- (a) *Number of driveway approaches.* Except as otherwise provided in this chapter, a lot or parcel is entitled to one driveway approach onto a local or collector street. Additional driveway approaches from a single family, ~~or two family,~~ three family, or four family use onto a local or collector street may be allowed through Class 1 driveway permit approval.
- (b) *Permitted access.*
 - (1) Driveway approaches onto local and collector streets shall only provide access to a permitted parking or vehicular use area, except where the driveway approach will provide access to a site controlled by a franchised utility service provider or a governmental entity.
 - (2) For a corner lot that abuts only local or collector streets, the driveway approach shall provide access to the street with the lower street classification.
- (c) *Spacing.* Driveway approaches providing direct access to a collector street shall be located no less than 200 feet from intersections with major arterials or minor arterials, measured from centerline to centerline.
- (d) *Vision clearance.* Driveway approaches onto local and collector streets shall comply with the vision clearance requirements set forth in SRC chapter 805.

Sec. 804.050. - Driveway approach development standards.

Driveway approaches shall conform to the following development standards:

- (a) *Design and construction.* Driveway approaches shall be designed and constructed in conformance with this chapter and the Public Works Design Standards.
- (b) *Width.*
 - (1) *Driveway approach width for single family, ~~and two family,~~ three family, and four family uses.* Driveway approaches serving single family, ~~and two family,~~ three

family, and four family uses shall conform to the minimum and maximum widths set forth in Table 804-1.

TABLE 804-1. DRIVEWAY APPROACH WIDTH FOR SINGLE FAMILY, ~~AND-TWO FAMILY,~~ THREE FAMILY, AND FOUR FAMILY USES

Number of Parking Spaces Served	Width	
	Minimum	Maximum
1 space	10 ft.	15 ft.
2 spaces	14 ft.	24 ft.
3 or more spaces	18 ft.	36 ft.

- (2) *Driveway approach width for uses other than single family, ~~and-two family,~~ three family, and four family.* Driveway approaches serving uses other than single family, ~~and-two family,~~ three family, and four family shall conform to the minimum and maximum widths set forth in Table 804-2.

TABLE 804-2. DRIVEWAY APPROACH WIDTH FOR USES OTHER THAN SINGLE FAMILY, ~~OR TWO FAMILY,~~ THREE FAMILY, OR FOUR FAMILY

Type of Driveway	Width	
	Minimum	Maximum
One-way driveway approach	12 ft.	20 ft.
Two-way driveway approach	22 ft.	40 ft.

- (3) *Measurement.* For purposes of this subsection, driveway approach width shall be determined by measurement of the paved surface of the driveway at the property line.

- (c) *Marking and signage.* Where required by the Public Works Design Standards, driveway approaches shall be clearly marked or signed and maintained in conformance with the Public Works Design Standards.

Sec. 806.015. - Amount off-street parking.

- (a) *Minimum required off-street parking.* Unless otherwise provided under the UDC, off-street parking shall be provided in amounts not less than those set forth in Table 806-1.

TABLE 806-1. MINIMUM OFF-STREET PARKING

Use	Minimum Number of Spaces Required ⁽¹⁾	Limitations & Qualifications
Household Living		
Single family	2	Applicable to all single family, unless noted below.
	1	Applicable to single family located within the CSDP area.
Two family	2 per dwelling unit	Applicable to all two family, unless noted below.
	1 per dwelling unit	Applicable to two family located within the CSDP area.
	3	Applicable to two family shared dwellings.
<u>Three family</u>	<u>1 per dwelling unit</u>	
<u>Four family</u>	<u>1 per dwelling unit</u>	
Multiple family ⁽²⁾	2 per dwelling unit	Applicable to multiple family consisting of 3 dwelling units.
	1 per dwelling unit	Applicable to multiple family consisting of 5 to 12 dwelling units. Applicable to multiple family consisting of 3 dwelling units located within the CSDP area, MU-I zone, or MU-II zone.
	<u>1 per studio unit or dwelling unit with 1 bedroom</u>	<u>Applicable to multiple family consisting of 13 or more dwelling units.</u>
	<u>1.5 per dwelling unit with 2 or more bedrooms</u>	<u>Applicable to multiple family consisting of 413 or more dwelling units.</u>
	<u>1 per dwelling unit</u>	<u>Applicable to multiple family consisting of 413 or more dwelling units located within the CSDP area, MU-I zone, or MU-II zone.</u>
	<u>1 per 4 dwelling units</u>	<u>Applicable to low income elderly housing.</u>
Group Living		
Room and board facilities	1 per guest room or suite	
Residential care	1 per 350 sq. ft.	
Nursing care	1 per 3 beds	

Lodging		
Short-term commercial lodging	1 per guest room or suite	
Long-term commercial lodging		
Nonprofit shelters	1 per guest room or suite	Applicable to nonprofit Shelters serving victims of domestic violence
	1 per 350 sq. ft.	Applicable to all other nonprofit shelters
Retail Sales and Service		
Eating and drinking establishments	1 per 250 sq. ft.	
Retail sales	1 per 900 sq. ft.	Applicable to the following retail sales activities: <ul style="list-style-type: none"> ■ Building materials, hardware, nurseries, and lawn and garden supply stores. <ul style="list-style-type: none"> ■ Auto supply stores. ■ Furniture and home furnishing stores. ■ Household appliance and radio, television, music, and consumer electronics stores.
	1 per 400 sq. ft.	Applicable to all other retail sales located within the MU-I zone or MU-II zone.
	1 per 250 sq. ft.	Applicable to all other retail sales located within all zones except the MU-I zone or MU-II zone.
Personal services	1 per 1,000 sq. ft.	Applicable to laundry, dry cleaning, and garment services.
	1 per 350 sq. ft.	Applicable to all other personal services.
Postal services and retail financial services	1 per 500 sq. ft.	
Shopping center	1 per 250 sq. ft.	
Business and Professional Services		
Office	1 per 350 sq. ft.	
Audio/visual media production		
Laboratory research and testing		
Office complex		

Motor Vehicle, Trailer, and Manufactured Dwelling Sales and Service		
Motor vehicle and manufactured dwelling and trailer sales	1 per 900 sq. ft.	
Motor vehicle services		
Taxicabs and car services		
Heavy vehicle and trailer sales		
Heavy vehicle and trailer service and storage		
Commercial parking	N/A	
Park-and-ride facilities		
Recreation, Entertainment, and Cultural Services and Facilities		
Commercial entertainment—indoor	1 per 5 seats or 10 feet of bench length	Applicable to theaters.
	3 per court, plus additional 1 per 5 seats or 10 feet of bench length	Applicable to tennis, racquetball, and handball courts.
	1 per 300 sq. ft.	Applicable to all commercial entertainment—indoor.
Commercial entertainment—outdoor	3 per court, plus additional 1 per 5 seats or 10 feet of bench length	Applicable to tennis, racquetball, and handball courts.
	4 per tee	Applicable to golf courses.
	1 per 2,000 sq. ft. of gross site area	Applicable to all other commercial entertainment—outdoor.
Major event entertainment	The greater of the following: 1 per 5 seats or 10 feet of bench length; or 1 per 25 sq. ft. of floor area of assembly space.	

Recreational and cultural community services	4 per tee	Applicable to golf courses.
	1 per 350 sq. ft.	Applicable to all other indoor Recreational and cultural community services.
	1 per 2,000 sq. ft. of gross site area	Applicable to all other outdoor Recreational and cultural community services.
Parks and open space	None	
Nonprofit membership assembly	1 per 350 sq. ft.	
Religious assembly	1 per 5 seats or 10 feet of bench length within the principle worship area; or 1 per 80 sq. ft. within the principal worship area, when no fixed seating or benches are provided.	
Health Services		
Medical centers/hospitals	1.5 per bed	
Outpatient medical services and laboratories	1 per 350 sq. ft.	
Education Services		
Day care	1 Day Care serving 1 to 12 persons	Parking requirement applies in addition to spaces required for any dwelling.
	2 Day Care serving 13 to 18 persons	
	3 Day Care serving 19 to 26 persons	
	4 Day Care serving 27 or more persons	
Basic education	2 per classroom	Applicable to elementary schools.
	1 per 6 students	Applicable to secondary schools.

		The number of students shall be calculated based on the total number of students the school is designed to accommodate.
Post-secondary and adult education	1 per 350 sq. ft.	Applicable to vocational and trade schools.
	1 per 4 students	Applicable to all other post-secondary and adult education. The number of students shall be calculated based on the total number of students the school is designed to accommodate.
Civic Services		
Governmental services	1 per 500 sq. ft.	
Social services	1 per 350 sq. ft.	
Governmental maintenance services and construction	The greater of the following: 0.75 per employee; or 1 per 5,000 sq. ft. (Less than 50,000 sq. ft.) 1 per 10,000 sq. ft. (50,000 to 100,000 sq. ft.) 1 per 15,000 sq. ft. (Greater than 100,000 sq. ft.)	
Public Safety		
Emergency services	1 per employee, plus 1 additional space per ambulance	Applicable to ambulance stations.
	1 per 500 sq. ft.	Applicable to all other emergency services.
Detention facilities	1 per 2,000 sq. ft.	
Military installations	1 per 500 sq. ft.	
Funeral and Related Services		
Cemeteries	1 per 350 sq. ft.	

Funeral and cremation services	1 per 5 seats or 10 feet of bench length in the chapel	
Construction Contracting, Repair, Maintenance, and Industrial Services		
Building and grounds services and construction contracting	The greater of the following: 0.75 per employee; or	
Industrial services	1 per 5,000 sq. ft. (Less than 50,000 sq. ft.) 1 per 10,000 sq. ft. (50,000 to 100,000 sq. ft.) 1 per 15,000 sq. ft. (Greater than 100,000 sq. ft.)	
General repair services	1 per 350 sq. ft.	
Cleaning plants	1 per 1,000 sq. ft.	
Wholesale Sales, Storage, and Distribution		
General wholesaling	1 per 1,500 sq. ft.	
Heavy wholesaling		
Warehousing and distribution	The greater of the following: 0.75 per employee; or	
Self-service storage	1 per 5,000 sq. ft. (Less than 50,000 sq. ft.) 1 per 10,000 sq. ft. (50,000 to 100,000 sq. ft.) 1 per 15,000 sq. ft. (Greater than 100,000 sq. ft.)	

Manufacturing		
General manufacturing	<p>The greater of the following: 0.75 per employee; or</p> <p>1 per 5,000, sq. ft. (Less than 50,000 sq. ft.)</p> <p>1 per 10,000 sq. ft. (50,000 to 100,000 sq. ft.)</p> <p>1 per 15,000 sq. ft. (Greater than 100,000 sq. ft.)</p>	
Heavy manufacturing		
Printing		
Transportation Facilities		
Aviation facilities	<p>The greater of the following: 0.75 per employee; or</p> <p>1 per 5,000 sq. ft. (Less than 50,000 sq. ft.)</p> <p>1 per 10,000 sq. ft. (50,000 to 100,000 sq. ft.)</p> <p>1 per 15,000 sq. ft. (Greater than 100,000 sq. ft.)</p>	
Passenger ground transportation facilities;		
Marine facilities	1 per boat berth or docking space.	Applicable to marinas.
	<p>The greater of the following: 0.75 per employee; or</p> <p>1 per 5,000 sq. ft.</p>	Applicable to all other marine facilities.

	(Less than 50,000 sq. ft.)	
	1 per 10,000 sq. ft. (50,000 to 100,000 sq. ft.)	
	1 per 15,000 sq. ft. (Greater than 100,000 sq. ft.)	
Utilities		
Basic utilities	The greater of the following: 0.75 per employee; or 1 per 5,000 sq. ft. (Less than 50,000 sq. ft.) 1 per 10,000 sq. ft. (50,000 to 100,000 sq. ft.) 1 per 15,000 sq. ft. (Greater than 100,000 sq. ft.)	
Drinking water treatment facilities		
Power generation facilities		
Data center facilities		
Waste related facilities		
Wireless communication facilities	None	
Fuel dealers	1 per 200 sq. ft.	
Mining and Natural Resource Extraction		
Petroleum and natural gas production	The greater of the following: 0.75 per employee; or 1 per 5,000 sq. ft. (Less than 50,000 sq. ft.) 1 per 10,000 sq. ft. (50,000 to 100,000 sq. ft.)	
Surface mining		

	sq. ft.) 1 per 15,000 sq. ft. (Greater than 100,000 sq. ft.)	
Farming, Forestry, and Animal Services		
Agriculture	5	Applicable when retail sales are involved.
Forestry		
Agriculture and forestry services	The greater of the following: 0.75 per employee; or 1 per 5,000 sq. ft. (Less than 50,000 sq. ft.) 1 per 10,000 sq. ft. (50,000 to 100,000 sq. ft.) 1 per 15,000 sq. ft. (Greater than 100,000 sq. ft.)	
Keeping of livestock and other animals	1 per 400 sq. ft.	
Animal services	1 per 400 sq. ft.	
Other Uses		
Accessory short-term rentals	None	
Temporary uses	Per SRC chapter 701	
Home occupations	1 per nonresident employee	Parking requirement applies in addition to spaces required for the dwelling unit.
Accessory dwelling units	None	
<p>⁽¹⁾ Unless otherwise provided, when required off-street parking is expressed in terms of a number of spaces per a square footage, the square footage shall equal the gross floor area.</p> <p>⁽²⁾ <u>The minimum number of spaces per dwelling unit may be reduced by 25 percent for dwelling units that are affordable to households with incomes equal to or less than 60 percent</u></p>		

of the median family income for the county in which the development is built or for the state, whichever is greater.

- (b) *Compact parking.* Up to 75 percent of the minimum off-street parking spaces required under this chapter may be compact parking spaces.
- (c) *Carpool and vanpool parking.* New developments with 60 or more required off-street parking spaces, and falling within the public services and industrial use classifications, and the business and professional services use category, shall designate a minimum of five percent of their total off-street parking spaces for carpool or vanpool parking.
- (d) *Maximum off-street parking.* Unless otherwise provided under the UDC, off-street parking shall not exceed the amounts set forth in Table 806-2.

TABLE 806-2. MAXIMUM OFF-STREET PARKING

Minimum Number of Off-Street Parking Spaces Required <i>(From Table 806-1)</i>	Maximum Number of Off-Street Parking Spaces Allowed
20 spaces or less	2.5 times minimum number of spaces required.
More than 20 spaces	1.75 times minimum number of spaces required.

- (e) *Garages.* Multiple family development with 13 or more dwelling units may not count off-street parking spaces located within individual garages that are fully enclosed, excluding parking structures, toward the required minimum number of off-street parking spaces. Off-street parking located in individual garages do count toward the maximum number of off-street parking spaces allowed.
- (fe) *Reductions to required off-street parking through alternative modes of transportation.*
 - (1) Construction of transit related improvements. When adjacent to transit service, minimum required off-street parking may be reduced by up to ten percent for redevelopment of an existing off-street parking area for transit-related improvements, including transit stops, pullouts and shelters, park and ride lots, transit-oriented developments, and similar facilities.
 - (2) Satisfaction of off-street parking through implementation of a plan for alternative modes of transportation. Minimum required off-street parking for uses or activities other than household living may be reduced through implementation of a plan providing for the use of alternative modes of transportation to decrease the need for off-street parking. The plan shall be reviewed as a Class 2 Adjustment under SRC chapter 250.

(g) Reductions to required off-street parking for multiple family developments.

(1) For multiple family developments, the minimum number of required off-street parking spaces may be reduced through one or more of the following options, provided that the total number of off-street parking spaces reduced shall not exceed 25 percent:

(A) Transit access. The minimum number of required off-street parking spaces may be reduced by 10 percent for developments that are located within one-quarter mile of a transit stop as measured along a route utilizing public or private streets that are existing or will be constructed with the development.

(B) Covered bicycle parking. The minimum number of required off-street parking spaces may be reduced by one space for every four covered bicycle parking spaces provided in addition to the minimum number of bicycle parking spaces required as set forth in SRC 806.055. The additional covered bicycle parking spaces must meet the standards of SRC 806.060 and must be located on site either outdoors or in a bike storage room that is accessible to all residents of the multiple family development.

(C) Shared car or van. The minimum number of required off-street parking spaces may be reduced by four spaces for every shared car or shuttle van that is provided on site and available for use by all residents.

Sec. 806.025. - Off-street parking and vehicle storage area development standards for single family, ~~and two family~~, three family, and four family uses or activities.

Unless otherwise provided under the UDC, off-street parking and vehicle storage areas for single family, ~~and two family~~, three family, and four family uses or activities shall be developed and maintained as provided in this section.

(a) Location within yards.

(1) *Front yard abutting street.* Within a front yard abutting a street, off-street parking and vehicle storage shall be allowed only:

(A) Within a garage or carport; or

(B) On a driveway leading to:

(i) A garage or carport;

(ii) A garage that has been legally converted to another use subsequent to its construction as a garage;

(iii) A screened off-street parking area; or

(iv) A screened vehicle storage area.

(2) *Side and rear yards abutting street.* Within side and rear yards abutting a street, off-street parking and vehicle storage shall be allowed only:

(A) Within a garage or carport;

(B) Within an off-street parking area or vehicle storage area that is screened as set forth in SRC 806.025(f); or

(C) On a driveway leading to:

- (i) A garage or carport;
 - (ii) A garage that has been legally converted to another use subsequent to its construction as a garage;
 - (iii) A screened off-street parking area; or
 - (iv) A screened vehicle storage area.
- (3) *Interior front, side, and rear yards.* Within interior front, side, and rear yards, off-street parking and vehicle storage shall be allowed only:
- (A) Within a garage or carport;
 - (B) Within an off-street parking area or vehicle storage area that is screened as set forth in SRC 806.025(f); or
 - (C) On a driveway leading to:
 - (i) A garage or carport;
 - (ii) A garage that has been legally converted to another use subsequent to its construction as a garage;
 - (iii) A screened off-street parking area; or
 - (iv) A screened vehicle storage area.
- (b) *Garage or carport vehicle entrance setback abutting street or flag lot accessway.* The vehicle entrance of a garage or carport facing a street or flag lot accessway shall be setback a minimum of 20 feet.
- (c) *Dimensions.* Off-street parking spaces shall conform to the minimum dimensions set forth in Table 806-3.

TABLE 806-3. MINIMUM OFF-STREET PARKING SPACE DIMENSIONS		
Type of Space	Width	Depth
Compact	8 ft.	15 ft.
Standard	9 ft.	19 ft.

- (d) *Maneuvering.* Where access to off-street parking is taken from an alley, a minimum maneuvering depth of 24 feet shall be provided between the back of the parking space and the opposite side of the alley.
- (e) *Surfacing.* Any area that is used for off-street parking shall be paved with a hard surface material meeting the Public Works Design Standards. Vehicle storage areas are not required to be paved.
- (f) *Screening.* Off-street parking areas and vehicle storage areas shall be screened as follows:
- (1) Off-street parking areas located within a garage or carport or on a driveway are not required to be screened. All other off-street parking areas shall be screened

from all public areas, public streets, and abutting residential uses by a minimum six-foot-tall sight-obscuring fence, wall, or hedge.

- (2) Vehicle storage areas within an enclosed structure or on a driveway are not required to be screened. All other vehicle storage areas shall be screened from all public areas, public streets, and abutting residential uses by a minimum six-foot-tall sight-obscuring fence, wall, or hedge.

Sec. 806.030. - Driveway development standards for single family, ~~and two family,~~ three family, and four family uses or activities.

Unless otherwise provided under the UDC, driveways for single family, ~~and two family,~~ three family, and four family uses or activities shall be developed and maintained as provided in this section.

- (a) *Location.* Driveways crossing from the lot line to a permitted off-street parking area by the shortest direct route shall be permitted within yards abutting streets.
- (b) *Dimensions.* Driveways shall conform to the minimum dimensions set forth in Table 806-4. The minimum width of a driveway serving more than one parking space must meet the standard set forth in Table 806-4 for only the first 20 feet of depth behind the parking spaces served; beyond 20 feet, the minimum width may be reduced to ten feet.

TABLE 806-4. MINIMUM DRIVEWAY DIMENSIONS		
Number of Parking Spaces Served	Width	Depth
1 space	10 ft.	20 ft.
2 spaces	16 ft.	20 ft.
3 or more spaces	22 ft.	20 ft.

- (c) *Surfacing.*
 - (1) All driveways, except those serving developments on parcels within approved partitions located more than 300 feet from an available sewer, shall be paved with a hard surface material meeting the Public Works Design Standards. Driveways serving developments on parcels within approved partitions located more than 300 feet from an available sewer are not required to be paved.
 - (2) Access to vehicle storage areas shall be paved with a hard surface material meeting the Public Works Design Standards when such access is being utilized for parking.

Sec. 806.035. - Off-street parking and vehicle use area development standards for uses or activities other than single family, ~~and two family,~~ three family, and four family.

Unless otherwise provided under the UDC, off-street parking and vehicle use areas, other than driveways and loading areas, for uses or activities other than single family, ~~and two family,~~ three family, and four family shall be developed and maintained as provided in this section.

- (a) *General applicability.* The off-street parking and vehicle use area development standards set forth in this section shall apply to:
 - (1) The development of new off-street parking and vehicle use areas;
 - (2) The expansion of existing off-street parking and vehicle use areas, where additional paved surface is added;
 - (3) The alteration of existing off-street parking and vehicle use areas, where the existing paved surface is replaced with a new paved surface; and
 - (4) The paving of an unpaved area.
- (b) *Location.*
 - (1) *Generally.* Off-street parking and vehicle use areas shall not be located within required setbacks.
 - (2) *Carpool and vanpool parking.* Carpool and vanpool parking shall be located so it is the closest employee parking to the building entrance normally used by employees; provided, however, it shall not be located closer than any parking designated for disabled parking.
 - (3) *Underground parking.* Off-street parking may be located underground in all zones, except the RA and RS zones. Such underground parking may be located beneath required setbacks; provided, however, no portion of the structure enclosing the underground parking shall project into the required setback, and all required setbacks located above the underground parking structure shall be landscaped as otherwise required under the UDC.
- (c) *Perimeter setbacks and landscaping.*
 - (1) *Perimeter setbacks and landscaping, generally.*
 - (A) *Perimeter setbacks.* Perimeter setbacks, as set forth in this subsection, shall be required for off-street parking and vehicle use areas abutting streets, abutting interior front, side, and rear property lines, and adjacent to buildings and structures. Perimeter setbacks for parking garages are set forth under subsection (c)(5) of this section. Perimeter setbacks are not required for:
 - (i) Off-street parking and vehicle use areas abutting an alley.
 - (ii) Vehicle storage areas within the IG zone.
 - (iii) Temporary and seasonal gravel off-street parking areas, approved pursuant to SRC chapter 701, abutting nonresidential zones, uses or activities other than household living, or local streets.
 - (iv) Gravel off-street parking areas, approved through a conditional use permit, abutting nonresidential zones, uses or activities other than household living, or local streets.
 - (v) Underground parking.
 - (B) *Perimeter landscaping.* Required perimeter setbacks for off-street parking and vehicle use areas shall be landscaped as set forth in this subsection.
 - (2) *Perimeter setbacks and landscaping abutting streets.* Unless a greater setback is required elsewhere within the UDC, off-street parking and vehicle use areas abutting

a street shall be setback and landscaped according to one the methods set forth in this subsection. Street trees located along an arterial street may be counted towards meeting the minimum required number of plant units.

- (A) *Method A.* The off-street parking and vehicle use area shall be setback a minimum of ten feet (see Figure 806-1). The setback shall be landscaped according to the Type A standard set forth in SRC chapter 807.

FIGURE 806-1. PERIMETER SETBACKS AND LANDSCAPING ABUTTING STREETS - METHOD A

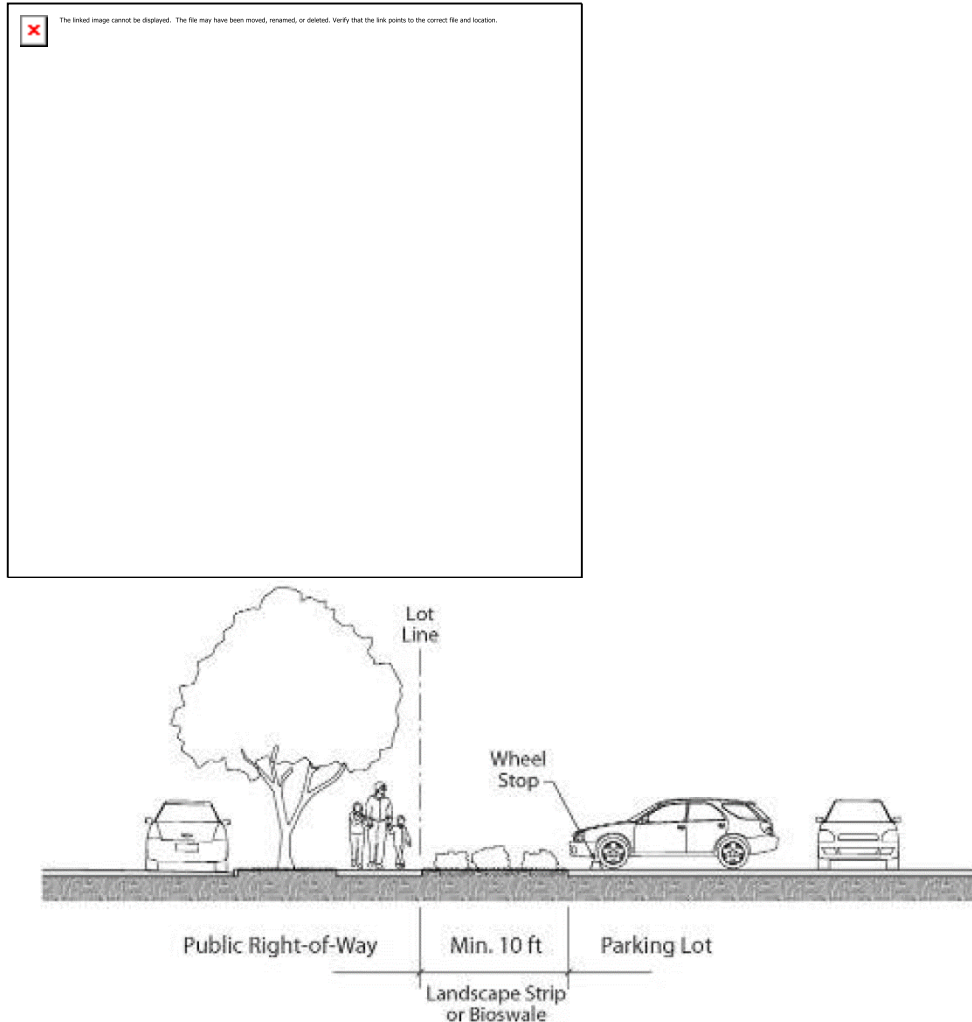

- (B) *Method B.* The off-street parking and vehicle use area shall be setback to accommodate a berm, the top of which shall be a minimum of 2.5 feet higher than the elevation of the abutting off-street parking or vehicle use area (see Figure 806-2). The berm shall have a slope no steeper than a 3:1 on all sides, and shall be landscaped according to the Type A standard set forth in SRC chapter 807 with plant materials to prevent erosion. The berm shall not alter natural drainage flows from abutting properties. Any portion of the berm that encroaches into a vision clearance area set forth in SRC chapter 805 shall have a height no greater than the maximum allowed under SRC 805.010.

FIGURE 806-2. PERIMETER SETBACKS AND LANDSCAPING ABUTTING STREETS- METHOD B

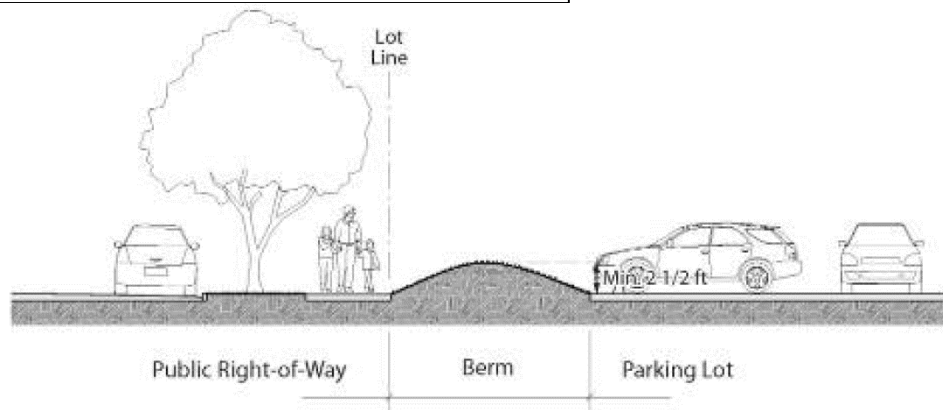
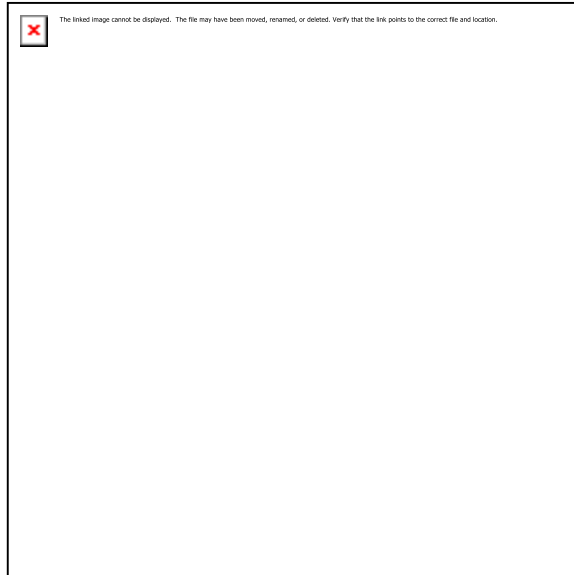

- (C) *Method C.* The off-street parking and vehicle use area shall be setback a minimum six feet to accommodate a minimum three-foot drop in grade from the elevation at the right-of-way line to the elevation of the abutting off-street parking or vehicular use area (see Figure 806-3). The setback shall be landscaped according to the Type A standard set forth in SRC chapter 807.

FIGURE 806-3. PERIMETER SETBACKS AND LANDSCAPING ABUTTING STREETS - METHOD C

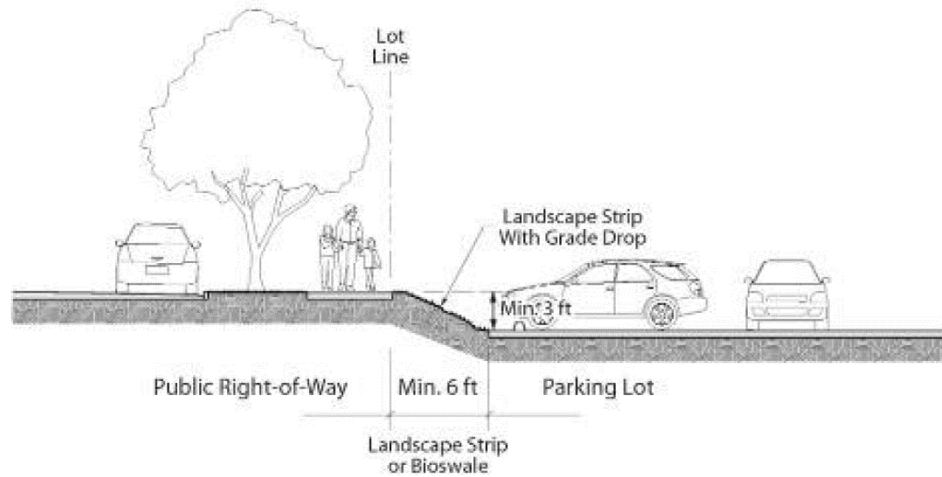
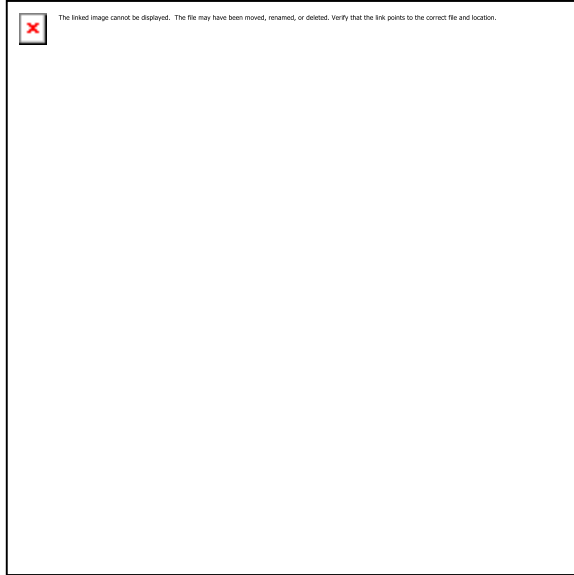

- (D) *Method D.* The off-street parking and vehicle use area shall be setback a minimum six feet in conjunction with a minimum three-foot-tall brick, stone, or finished concrete wall (see Figure 806-4). The wall shall be located adjacent to, but entirely outside, the required setback. The setback shall be landscaped according to the Type A standard set forth in SRC chapter 807. Any portion of the wall that encroaches into a vision clearance area set forth in SRC chapter 805 shall have a height no greater than the maximum allowed under SRC 805.010.

FIGURE 806-4. PERIMETER SETBACKS AND LANDSCAPING ABUTTING STREETS - METHOD D

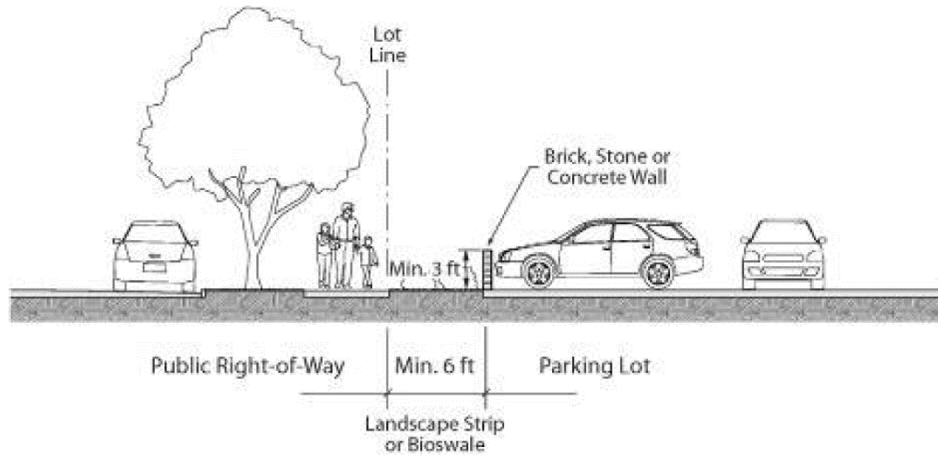
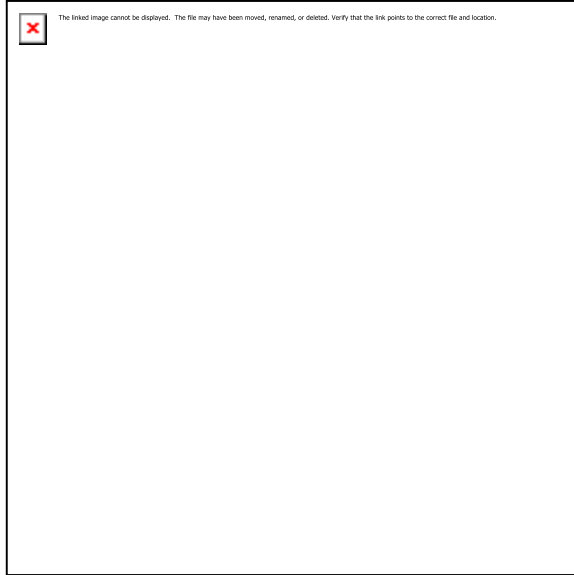

(E) *Method E.* The off-street parking and vehicle use area shall be setback a minimum of six feet to accommodate green stormwater infrastructure meeting the Public Works Design Standards.

(3) *Perimeter setbacks and landscaping abutting interior front, side, and rear property lines.* Unless a greater setback is required elsewhere within the UDC, off-street parking and vehicle use areas abutting an interior front, side, or rear property line shall be setback a minimum of five feet (see Figure 806-5). The setback shall be landscaped according to the Type A standard set forth in SRC chapter 807.

FIGURE 806-5. LANDSCAPING ADJACENT TO AN ADJACENT LOT

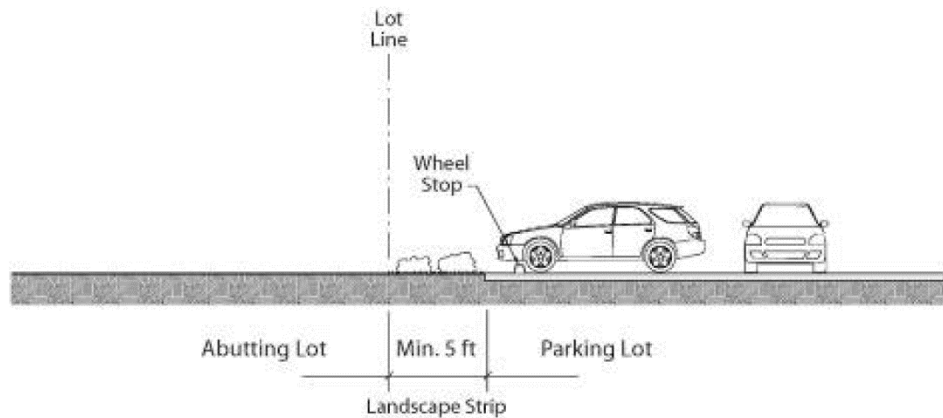
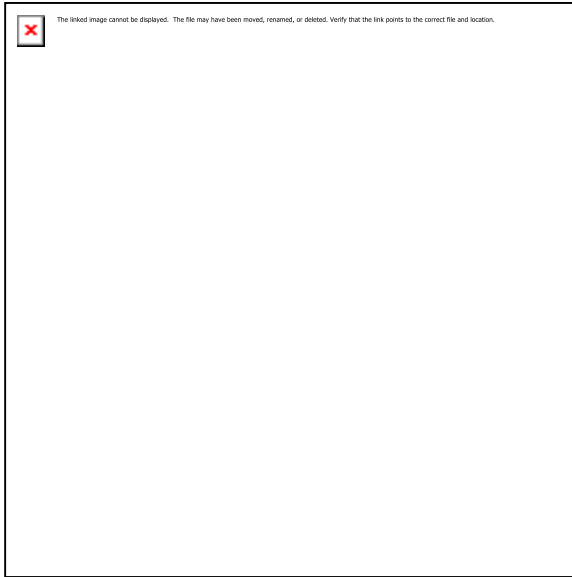

- (4) *Setback adjacent to buildings and structures.* Except for drive-through lanes, where an off-street parking or vehicular use area is located adjacent to a building or structure, the off-street parking or vehicular use area shall be setback from the exterior wall of the building or structure by a minimum five-foot-wide landscape strip, planted to the Type A standard set forth in SRC chapter 807, or by a minimum five-foot-wide paved pedestrian walkway (see Figure 806-6). A landscape strip or paved pedestrian walkway is not required for drive-through lanes located adjacent to a building or structure.

FIGURE 806-6. LANDSCAPING ADJACENT TO A BUILDING

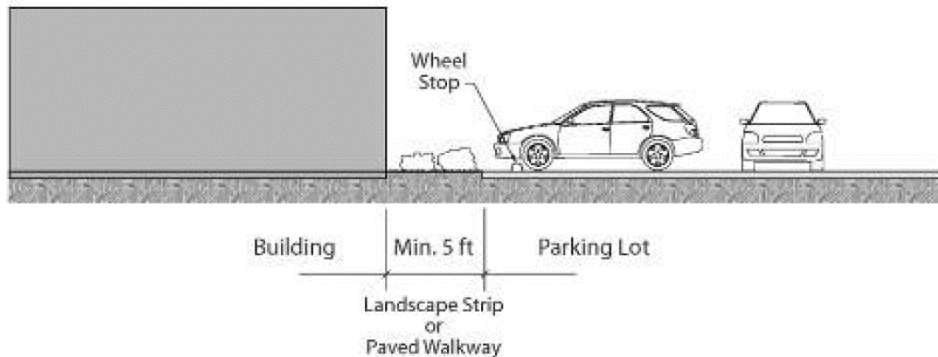
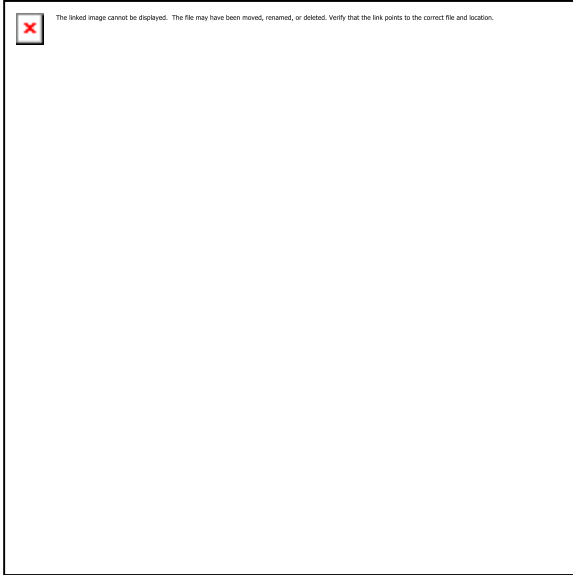

- (5) *Perimeter setbacks and landscaping for parking garages.* Perimeter setbacks and landscaping as set forth in subsection (c) of this section shall be required for parking garages; provided, however, perimeter setbacks and landscaping are not required for:
- (A) Any portion of a parking garage with frontage on a street and containing ground floor uses or activities other than parking.
 - (B) Any parking garage within an industrial zone, public zone, or commercial zone, other than a CO zone, that abuts an interior front, side, or rear property line where there is no required building setback.
 - (C) Any parking garage abutting an alley.
- (d) *Interior landscaping.*
- (1) *Interior landscaping, generally.* Interior landscaping, as set forth in this subsection, shall be required for off-street parking areas 5,000 square feet or greater in size; provided, however, interior landscaping is not required for:
- (A) Vehicle storage areas.
 - (B) Vehicle display areas.

- (C) Temporary and seasonal gravel off-street parking areas, approved pursuant to SRC chapter 701.
 - (D) Gravel off-street parking areas, approved through a conditional use permit.
 - (E) Underground parking.
 - (F) Parking garages.
- (2) *Minimum percentage of interior landscaping required.* Interior landscaping shall be provided in amounts not less than those set forth in Table 806-5. For purposes of this subsection, the total interior area of an off-street parking area is the sum of all areas within the perimeter of the off-street parking area, including parking spaces, aisles, planting islands, corner areas, and curbed areas, but not including interior driveways. Perimeter landscaped setbacks and required landscape strips separating off-street parking areas from buildings and structures shall not count towards satisfying minimum interior landscaping requirements.

TABLE 806-5. INTERIOR OFF-STREET PARKING AREA LANDSCAPING	
Total Interior Area of Off-Street Parking Area	Percentage Required to be Landscaped
Less than 50,000 sq. ft.	Min. 5%
50,000 sq. ft. and greater	Min. 8%

- (3) *Trees.* A minimum of one deciduous shade tree shall be planted for every 12 parking spaces within an off-street parking area. Trees may be clustered within landscape islands or planter bays, and shall be distributed throughout the off-street parking area to create a canopy effect and to break up expanses of paving and long rows of parking spaces.
- (4) *Landscape islands and planter bays.* Landscape islands and planter bays shall have a minimum planting area of 25 square feet, and shall have a minimum width of five feet (see Figure 806-7).

FIGURE 806-7. INTERIOR LANDSCAPING

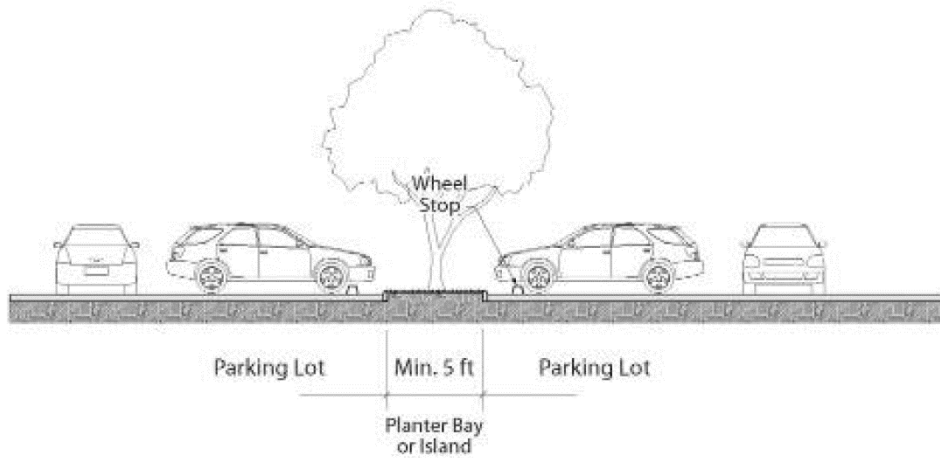
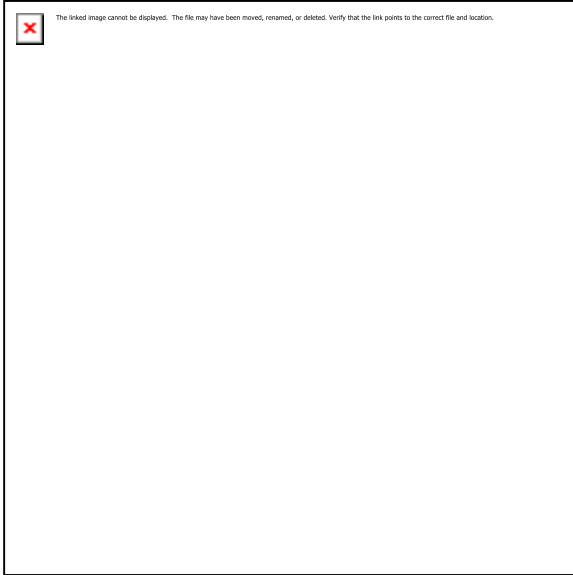

- (e) *Off-street parking area dimensions.* Off-street parking areas shall conform to the minimum dimensions set forth in Table 806-6; provided, however, minimum off-street parking area dimensions shall not apply to:
- (1) Vehicle storage areas.
 - (2) Vehicle display areas.

TABLE 806-6. MINIMUM OFF-STREET PARKING AREA DIMENSIONS

Parking Angle A ⁽³⁾	Type of Space	Stall Width B ⁽³⁾	Stall to Curb C ⁽³⁾	Aisle Width ^{(1),(2)} D ⁽³⁾	Curb Length E ⁽³⁾	Front of Stall to Front of Stall F1 ⁽³⁾	Overlap Front of Stall to Front of Stall F2 ⁽³⁾
0° (Parallel)	Compact	8'0"	8.0	12.0	22.0	28.0	-
	Standard	8'0"	8.0	12.0	22.0	28.0	-

20°	Compact	8'0"	12.6	11.0	23.4	36.2	28.7
	Standard	8'6" (4)	14.5	11.0	24.9	40.0	32.0
		9'6"	15.5	11.0	27.8	42.0	33.1
		10'0"	15.9	11.0	19.2	42.8	33.4
30°	Compact	8'0"	14.4	11.0	16.0	39.8	32.9
	Standard	8'6" (4)	16.9	11.0	17.0	44.8	37.4
		9'0"	17.3	11.0	18.0	45.6	37.8
		9'6"	17.8	11.0	19.0	46.6	38.4
10'0"		18.2	11.0	20.0	47.4	38.7	
40°	Compact	8'0"	15.8	12.0	12.4	43.6	37.5
	Standard	8'6" (4)	18.7	12.0	13.2	49.4	42.9
		9'0"	19.1	12.0	14.0	50.2	43.3
		9'6"	19.5	12.0	14.8	51.0	43.7
10'0"		19.9	12.0	15.6	51.8	44.1	
45°	Compact	8'0"	16.3	13.5	11.3	46.1	40.5
	Standard	8'6" (4)	19.4	13.5	12.0	52.3	46.3
		9'0"	19.8	13.0	12.7	52.6	46.2
		9'6"	20.1	13.0	13.4	53.2	46.5
10'0"		20.5	13.0	14.1	54.0	46.9	
50°	Compact	8'0"	16.6	15.5	10.4	48.7	43.6
	Standard	8'6" (4)	20.0	15.5	11.1	55.5	50.0
		9'0"	20.4	15.0	11.7	55.8	50.0
		9'6"	20.7	15.0	12.4	56.4	50.3
10'0"		21.0	15.0	13.1	57.0	50.6	
60°	Compact	8'0"	17.0	18.5	9.2	52.5	48.5
	Standard	8'6" (4)	20.7	18.5	9.8	59.9	55.6
		9'0"	21.0	18.0	10.4	60.0	55.7
		9'6"	21.2	18.0	11.0	60.4	55.6
10'0"		21.5	18.0	11.5	61.0	56.0	
70°	Compact	8'0"	16.8	19.5	8.5	53.1	50.4
	Standard	8'6" (4)	20.8	19.5	9.0	61.1	58.2

		9'0"	21.0	19.0	9.6	61.0	57.9
		9'6"	21.2	18.5	10.1	60.9	57.7
		10'0"	21.2	18.0	10.6	60.4	57.0
80°	Compact	8'0"	16.2	22.0	8.1	56.4	55.0
	Standard	9'0"	20.3	24.0	9.1	64.3	62.7
		9'6"	20.4	24.0	9.6	64.4	62.7
		10'0"	20.5	24.0	10.2	65.0	63.3
90°	Compact	8'0"	15.0	22.0	8.0	54.0	-
		8'6" ⁽⁵⁾	15.0	22.0	8.0	54.0	-
	Standard	9'0"	19.0	24.0	9.0	62.0	-
		9'6"	19.0	24.0	9.5	62.0	-
		10'0"	19.0	24.0	10.0	62.0	-

Limitations and Qualifications

- (1) For two-way circulation the width of an aisle shall be a minimum of 22 feet.
- (2) The width of an aisle serving both standard and compact parking spaces 80 degrees or more shall be a minimum of 24 feet.
- (3) See Figure 806-8 for corresponding off-street parking area layout requirements.
- (4) Minimum 8'6" standard stall width applies within parking structures of two or more stories.
- (5) Minimum 8'6" compact stall width applies when the side of the parking space abuts a wall or post.

FIGURE 806-8. OFF-STREET PARKING AREA LAYOUT REQUIREMENTS

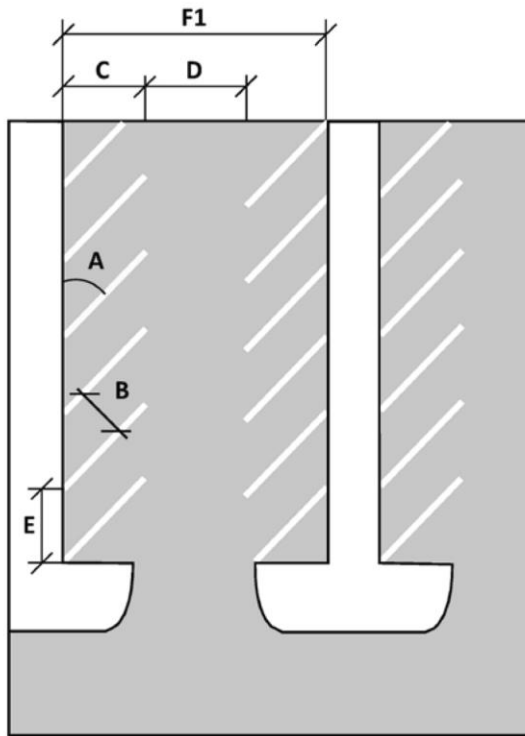
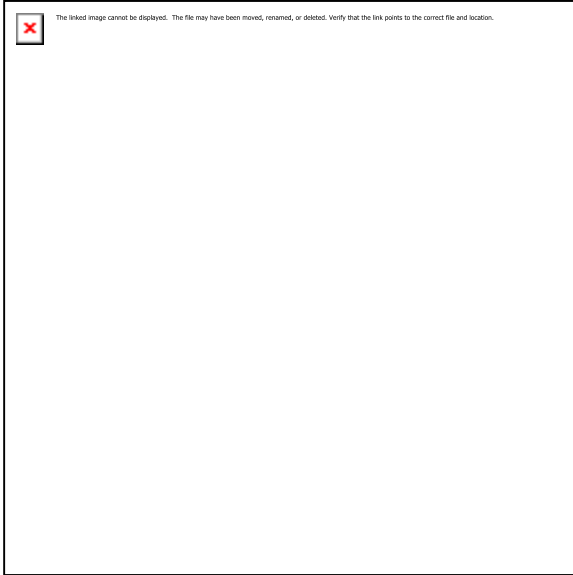

- (f) *Grade.* Off-street parking and vehicle use areas shall not exceed a maximum grade of ten percent. Ramps shall not exceed a maximum grade of 15 percent.
- (g) *Surfacing.* Off-street parking and vehicle use areas shall be paved with a hard surface material meeting the Public Works Design Standards; provided, however, up to two feet of the front of a parking space may be landscaped with ground cover plants (see Figure 806-9). Such two-foot landscaped area counts towards meeting interior off-street parking area landscaping requirements, but shall not count towards meeting perimeter setbacks and landscaping requirements. Paving is not required for:
 - (1) Vehicle storage areas within the IG zone.

- (2) Temporary and seasonal gravel off-street parking areas, approved pursuant to SRC chapter 701.
- (3) Gravel off-street parking areas, approved through a conditional use permit.

FIGURE 806-9. LANDSCAPED FRONT PORTION OF PARKING STALL

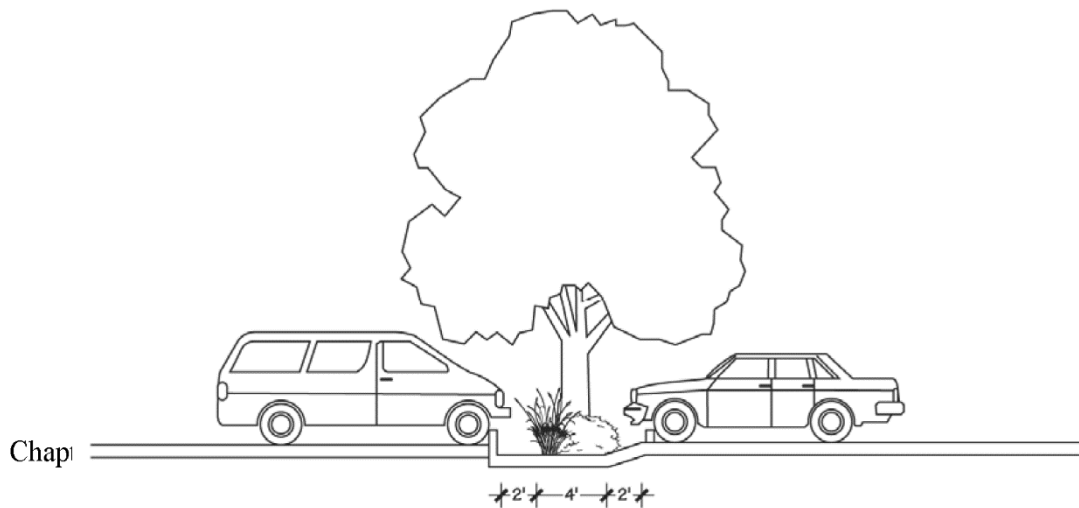
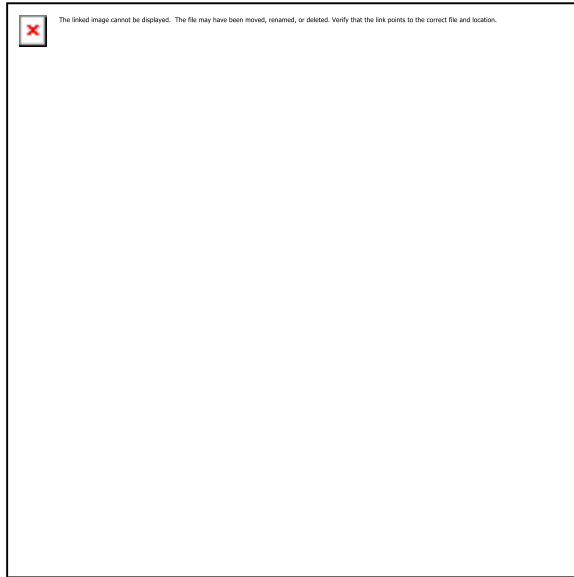

- (h) *Drainage.* Off-street parking and vehicle use areas shall be adequately designed, graded, and drained according to the Public Works Design Standards, or to the approval of the Director.
- (i) *Bumper guards or wheel barriers.* Off-street parking and vehicle use areas shall include bumper guards or wheel barriers so that no portion of a vehicle will overhang or project into required setbacks and landscaped areas, pedestrian accessways, streets or alleys, or abutting property; provided, however, bumper guards or wheel barriers are not required for:
 - (1) Vehicle storage areas.

- (2) Vehicle sales display areas.
- (j) *Off-street parking area striping.* Off-street parking areas shall be striped in conformance with the off-street parking area dimension standards set forth in Table 806-6; provided, however, off-street parking area striping shall not be required for:
 - (1) Vehicle storage areas.
 - (2) Vehicle sales display areas.
 - (3) Temporary and seasonal gravel off-street parking areas, approved pursuant to SRC chapter 701.
 - (4) Gravel off-street parking areas, approved through a conditional use permit.
- (k) *Marking and signage.*
 - (1) *Off-street parking and vehicle use area circulation.* Where directional signs and pavement markings are included within an off-street parking or vehicle use area to control vehicle movement, such signs and marking shall conform to the Manual of Uniform Traffic Control Devices.
 - (2) *Compact parking.* Compact parking spaces shall be clearly marked indicating the spaces are reserved for compact parking only.
 - (3) *Carpool and vanpool parking.* Carpool and vanpool parking spaces shall be posted with signs indicating the spaces are reserved for carpool or vanpool use only before 9:00 a.m. on weekdays.
- (l) *Lighting.* Lighting for off-street parking and vehicle use areas shall not shine or reflect onto adjacent residentially zoned property, or property used for uses or activities falling under household living, or cast glare onto the street.
- (m) *Off-street parking area screening.* Off-street parking areas with more than six spaces shall be screened from abutting residentially zoned property, or property used for uses or activities falling under household living, by a minimum six-foot-tall sight-obscuring fence, wall, or hedge; provided, however, screening is not required for vehicle storage areas within the IG zone.

Sec. 806.040. - Driveway development standards for uses or activities other than single family, ~~or two family, three family, or four family.~~

Unless otherwise provided under the UDC, driveways for uses or activities other than single family, ~~or two family, three family, or four family~~ shall be developed and maintained as provided in this section.

- (a) *Access.* Off-street parking and vehicle use areas shall have either separate driveways for ingress and egress, a single driveway for ingress and egress with an adequate turnaround that is always available, or a loop to the single point of access. The driveway approaches to the driveways shall conform to SRC chapter 804.
- (b) *Location.* Driveways shall not be located within required setbacks except where:
 - (1) The driveway provides direct access to the street, alley, or abutting property.
 - (2) The driveway is a shared driveway located over the common lot line and providing access to two or more uses.

(c) *Setbacks and landscaping.*

(1) *Perimeter setbacks and landscaping, generally.* Perimeter setbacks and landscaping as set forth in this subsection shall be required for driveways abutting streets and abutting interior front, side, and rear property lines; provided, however, perimeter setbacks and landscaping are not required where:

(A) The driveway provides direct access to the street, alley, or abutting property.

(B) The driveway is a shared driveway located over the common lot line and providing access to two or more uses.

(2) *Perimeter setbacks and landscaping abutting streets.* Unless a greater setback is required elsewhere within the UDC, driveways abutting a street shall be setback and landscaped according to the off-street parking and vehicle use area perimeter setbacks and landscaping standards set forth under SRC 806.035(c)(2).

(3) *Perimeter setbacks and landscaping abutting interior front, side, and rear property lines.* Unless a greater setback is required elsewhere within the UDC, driveways abutting an interior front, side, or rear property line shall be setback a minimum of five feet. The setback shall be landscaped according to the Type A standard set forth in SRC chapter 807.

(d) *Dimensions.* Driveways shall conform to the minimum width set forth in Table 806-7.

TABLE 806-7. MINIMUM DRIVEWAY WIDTH		
Type of Driveway	Width	Inside Radius of Curves & Corners
One-way driveway	12 ft.	25 ft., measured at curb or pavement edge
Two-way driveway	22 ft.	25 ft., measured at curb or pavement edge

(e) *Surfacing.* All driveways shall be paved with a hard surface material meeting the Public Works Design Standards.

(f) *Drainage.* Driveways shall be adequately designed, graded, and drained according to the Public Works Design Standards, or to the approval of the Director.

(g) *"No Parking" signs.* Driveways shall be posted with one "no parking" sign for every 60 feet of driveway length, but in no event shall less than two signs be posted.

Sec. 806.055. - Amount of bicycle parking.

Unless otherwise provided under the UDC, bicycle parking shall be provided in amounts not less than those set forth in Table 806-8.

TABLE 806-8. MINIMUM BICYCLE PARKING		
Use	Minimum Number of Spaces Required ⁽¹⁾	Limitations & Qualifications

Household Living		
Single family	None	
Two family		
<u>Three family</u>		
<u>Four family</u>		
Multiple family	The greater of 4 spaces or 0.1 spaces per dwelling unit.	
Group Living		
Room and board facilities	The greater of 4 spaces or 1 space per 50 rooms.	
Residential care	The greater of the following: 4 spaces; or 1 per 3,500 sq. ft. for first 50,000 sq. ft.; plus 1 per 7,000 sq. ft. for 50,000 to 100,000 sq. ft.; plus 1 per 14,000 sq. ft. for remaining square footage over 100,000 sq. ft.	
Nursing care	1 per 30 beds	
Lodging		
Short-term commercial lodging	The greater of 4 spaces or 1 space per 50 rooms.	
Long-term commercial lodging		
Nonprofit shelters	The greater of the following: 4 spaces; or 1 per 3,500 sq. ft. for first 50,000 sq. ft.;	

	<p>plus 1 per 7,000 sq. ft. for 50,000 to 100,000 sq. ft.;</p> <p>plus 1 per 14,000 sq. ft. for remaining square footage over 100,000 sq. ft.</p>	
Retail Sales and Service		
Eating and drinking establishments	The greater of 4 spaces or 1 space per 1,000 sq. ft.	
Retail sales	<p>The greater of the following: 4 spaces; or 1 per 10,000 sq. ft. for first 50,000 sq. ft.;</p> <p>plus 1 per 20,000 sq. ft. for 50,000 to 100,000 sq. ft.;</p> <p>plus 1 per 30,000 sq. ft. for remaining square footage over 100,000 sq. ft.</p>	
Personal services	1 per 10,000 sq. ft.	Applicable to laundry, dry cleaning, and garment services.
	The greater of 4 spaces or 1 space per 3,500 sq. ft.	Applicable to all other personal services.
Postal services and retail financial services	The greater of 4 spaces or 1 space per 3,000 sq. ft.	
Shopping center	<p>The greater of the following: 4 spaces; or 1 per 10,000 sq. ft. for first 50,000 sq. ft.;</p> <p>Plus 1 per 20,000 sq. ft. for 50,000 to 100,000 sq. ft.;</p> <p>plus</p>	

	1 per 30,000 sq. ft. for remaining square footage over 100,000 sq. ft.	
Business and Professional Services		
Office	The greater of the following: 4 spaces; or 1 per 3,500 sq. ft. for first 50,000 sq. ft.; plus 1 per 7,000 sq. ft. for 50,000 to 100,000 sq. ft.; plus 1 per 14,000 sq. ft. for remaining square footage over 100,000 sq. ft.	
Laboratory research and testing		
Office complex		
Audio/visual media production	The greater of the following: 4 spaces; or 1 per 10,000 sq. ft. for first 50,000 sq. ft.; plus 1 per 20,000 sq. ft. for 50,000 to 100,000 sq. ft.; plus 1 per 30,000 sq. ft. for remaining square footage over 100,000 sq. ft.	Applicable to broadcasting studios.
	The greater of 4 spaces or 1 per 3,500 sq. ft.	Applicable to all other audio/visual media production.
Motor Vehicle, Trailer, and Manufactured Dwelling Sales and Service		
Motor vehicle and manufactured dwelling and trailer sales	1 per 9,000 sq. ft.	
Motor vehicle services		
Taxicabs and car services		

Heavy vehicle and trailer sales		
Heavy vehicle and trailer service and storage		
Commercial parking	1 per 30 vehicle parking spaces	
Park-and-ride facilities		
Recreation, Entertainment, and Cultural Services and Facilities		
Commercial entertainment—indoor	The greater of 4 spaces or 1 space per 50 seats or 100 feet of bench length	Applicable to theaters.
	The greater of 4 spaces or 1 space per court.	Applicable to tennis, racquetball, and handball courts.
	The greater of 4 spaces or 1 space per 500 sq. ft.	Applicable to all other commercial entertainment—indoor.
Commercial entertainment—outdoor	The greater of 4 spaces or 1 space per court	Applicable to tennis, racquetball, and handball courts.
	4	Applicable to golf courses.
	None	Applicable to drive-in movie theaters.
	The greater of 4 spaces or 1 space per 30 vehicle parking spaces	Applicable to all other commercial entertainment—outdoor.
Major event entertainment	The greater of 4 spaces or 1 space per 50 seats or 100 ft. of bench length	
	4	Applicable to golf courses.

Recreational and cultural community services	The greater of the following: 4 spaces; or 1 per 3,500 sq. ft. for first 50,000 sq. ft.; plus 1 per 7,000 sq. ft. for 50,000 to 100,000 sq. ft.; plus 1 per 14,000 sq. ft. for remaining square footage over 100,000 sq. ft.	Applicable to all other indoor recreational and cultural community services.
	The greater of 4 spaces or 1 space per 30 vehicle parking spaces.	Applicable to all other outdoor recreational and cultural community services.
Parks and open space	The greater of 4 spaces or 1 space per 30 vehicle parking spaces.	
Nonprofit membership assembly	1 per 30 vehicle parking spaces.	
Religious assembly		
Health Services		
Medical centers/hospitals	The greater of 4 spaces or 1 per 30 beds	
Outpatient medical services and laboratories	The greater of 4 spaces or 1 per 3,500 sq. ft.	
Education Services		
Day care	4	
Basic education	2 per classroom	
Post-secondary and adult education	The greater of the following: 4 spaces; or 1 per 3,500 sq. ft. for first	Applicable to vocational and trade schools.

	<p>50,000 sq. ft.; plus 1 per 7,000 sq. ft. for 50,000 to 100,000 sq. ft.; plus 1 per 14,000 sq. ft. for remaining square footage over 100,000 sq. ft.</p>	
	The greater of 4 spaces or 1 per 10,000 sq. ft.	Applicable to all other post-secondary and adult education.
Civic Services		
Governmental services	1 per 5,000 sq. ft.	
Social services	<p>The greater of the following: 4 spaces; or 1 per 3,500 sq. ft. for first 50,000 sq. ft.; plus 1 per 7,000 sq. ft. for 50,000 to 100,000 sq. ft.; plus 1 per 14,000 sq. ft. for remaining square footage over 100,000 sq. ft.</p>	
Governmental maintenance services and construction	4	
Public Safety		
Emergency services	None	Applicable to ambulance stations.
	1 per 5,000 sq. ft.	Applicable to all other emergency services.
Detention facilities	1 per 50 beds	
Military installations	1 per 5,000 sq. ft.	

Funeral and Related Services		
Cemeteries	The greater of the following: 4 spaces; or 1 per 3,500 sq. ft. for first 50,000 sq. ft.; plus 1 per 7,000 sq. ft. for 50,000 to 100,000 sq. ft.; plus 1 per 14,000 sq. ft. for remaining square footage over 100,000 sq. ft.	
Funeral and cremation services	1 per 50 seats or 100 feet of bench length in the chapel	
Construction Contracting, Repair, Maintenance, and Industrial Services		
Building and grounds services and construction contracting	4	
General repair services	The greater of the following: 4 spaces; or 1 per 3,500 sq. ft. for first 50,000 sq. ft.; plus 1 per 7,000 sq. ft. for 50,000 to 100,000 sq. ft.; plus 1 per 14,000 sq. ft. for remaining square footage over 100,000 sq. ft.	
Cleaning plants	1 per 10,000 sq. ft.	
Industrial services	The greater of the following: 4 spaces; or 1 per 10,000 sq. ft. for first 50,000 sq. ft.; plus 1 per 20,000 sq. ft. for 50,000 to 100,000 sq. ft.;	

	plus 1 per 30,000 sq. ft. for remaining square footage over 100,000 sq. ft.	
Wholesale Sales, Storage, and Distribution		
General wholesaling	1 per 15,000 sq. ft.	
Heavy wholesaling		
Warehousing and distribution	The greater of the following: 4 spaces; or: 1 per 10,000 sq. ft. for first 50,000 sq. ft.; plus 1 per 20,000 sq. ft. for 50,000 to 100,000 sq. ft.; plus 1 per 30,000 sq. ft. for remaining square footage over 100,000 sq. ft.	
Self-service storage	None	
Manufacturing		
General manufacturing	The greater of the following: 4 spaces; or: 1 per 10,000 sq. ft. for first 50,000 sq. ft.; plus 1 per 20,000 sq. ft. for 50,000 to 100,000 sq. ft.; plus 1 per 30,000 sq. ft. for remaining square footage over 100,000 sq. ft.	
Heavy manufacturing		
Printing		
Transportation Facilities		
Aviation facilities		

Passenger ground transportation facilities	The greater of the following: 4 spaces; or: 1 per 10,000 sq. ft. for first 50,000 sq. ft.; plus 1 per 20,000 sq. ft. for 50,000 to 100,000 sq. ft.; plus 1 per 30,000 sq. ft. for remaining square footage over 100,000 sq. ft.	
	2	Applicable to marinas.
Marine facilities	The greater of the following: 4 spaces; or: 1 per 10,000 sq. ft. for first 50,000 sq. ft.; plus 1 per 20,000 sq. ft. for 50,000 to 100,000 sq. ft.; plus 1 per 30,000 sq. ft. for remaining square footage over 100,000 sq. ft.	Applicable to all other marine facilities.
Utilities		
Basic utilities	The greater of the following: 4 spaces; or: 1 per 10,000 sq. ft. for first 50,000 sq. ft.; plus 1 per 20,000 sq. ft. for 50,000 to 100,000 sq. ft.; plus 1 per 30,000 sq. ft. for remaining square footage over 100,000 sq. ft.	
Drinking water treatment facilities		
Power generation facilities		
Data center facilities		
Waste related facilities		
Fuel dealers		
Wireless communication facilities	None	

Mining and Natural Resource Extraction		
Petroleum and natural gas production	4	
Surface mining		
Farming, Forestry, and Animal Services		
Agriculture	2	Applicable when retail sales are involved.
Forestry		
Agriculture and forestry services	The greater of the following: 4 spaces; or: 1 per 10,000 sq. ft. for first 50,000 sq. ft.; plus 1 per 20,000 sq. ft. for 50,000 to 100,000 sq. ft.; plus 1 per 30,000 sq. ft. for remaining square footage over 100,000 sq. ft.	
Keeping of livestock and other animals	2	Applicable when retail sales are involved.
Animal services		
Other Uses		
Accessory short-term rentals	None	
Temporary uses	None	
Home occupations	None	
Accessory dwelling unit	None	
(1) Unless otherwise provided, when required bicycle parking is expressed in terms of a number of spaces per a square footage, the square footage shall equal the gross floor area.		

Sec. 806.075. - Amount of off-street loading.

Unless otherwise provided under the UDC, off-street loading shall be provided in amounts not less than those set forth in Table 806-9.

TABLE 806-9. MINIMUM OFF-STREET LOADING; DIMENSIONS						
Use Category/Use	Minimum Number of Spaces Required (1)		Dimensions			Limitations & Qualifications
			Width	Length	Height	
<p><u>Use:</u></p> <ul style="list-style-type: none"> ■ Single family ■ Two family ■ <u>Three family</u> ■ <u>Four family</u> ■ Commercial parking ■ Park-and-ride facility ■ Parks and open space ■ Cemeteries ■ Basic utilities ■ Wireless communication facilities ■ Agriculture ■ Forestry ■ Accessory short-term rentals ■ Temporary uses ■ Home occupations ■ Accessory dwelling units 	None		N/A	N/A	N/A	
	None	05 to 49 dwelling units	N/A	N/A	N/A	

<p>Use:</p> <ul style="list-style-type: none"> ■ Multiple family 	1	50 to 99 dwelling units	12 ft.	19 ft.	12 ft.	<p>If a recreational or service building is provided, at least 1 of the required loading spaces shall be located in conjunction with the recreational or service building.</p>
	2	100 to 199 dwelling units	12 ft.	19 ft.	12 ft.	
	3	200 or more dwelling units	12 ft.	19 ft.	12 ft.	
<p>Use Category:</p> <ul style="list-style-type: none"> ■ Business and professional services <p>Use:</p> <ul style="list-style-type: none"> ■ Outpatient medical services and laboratories ■ Governmental services ■ Social services ■ Keeping of livestock and other animals <ul style="list-style-type: none"> ■ Animal services 	None	Less than 5,000 sq. ft.	N/A	N/A	N/A	
	1	5,000 to 60,000 sq. ft.	12 ft.	19 ft.	12 ft.	
	2	60,001 to 250,000 sq. ft.	12 ft.	19 ft.	12 ft.	
	Additional spaces required	Greater than 250,000 sq. ft.	12 ft.	19 ft.	12 ft.	<p>For each additional 100,000 square feet, or any portion thereof, of building area over 250,000 sq. ft., 1 additional loading space is required.</p>
<p>Use Category:</p> <ul style="list-style-type: none"> ■ Group living ■ Lodging ■ Retail sales and service ■ Education services 	None	Less than 5,000 sq. ft.	N/A	N/A	N/A	
	1	5,000 to 60,000 sq. ft.	12 ft.	30 ft.	14 ft.	
	2	60,001 to 250,000 sq. ft.	12 ft.	30 ft.	14 ft.	

<p><u>Use:</u></p> <ul style="list-style-type: none"> ■ Commercial entertainment indoor ■ Commercial entertainment—outdoor ■ Major event entertainment ■ Recreation and cultural community services ■ Nonprofit membership assembly ■ Religious assembly ■ Medical centers/hospitals ■ Emergency services ■ Funeral and cremation services ■ General repair services ■ Agriculture and forestry services 	Additional Spaces Required	Greater than 250,000 sq. ft.	12 ft.	30 ft.	14 ft.	For each additional 100,000 square feet, or any portion thereof, of building area over 250,000 sq. ft., 1 additional loading space is required.
<p><u>Use Category:</u></p> <ul style="list-style-type: none"> ■ Wholesale sales, storage, and distribution ■ Manufacturing ■ Transportation 	None	Less than 5,000 sq. ft.	N/A	N/A	N/A	
	1	5,000 to 100,000 sq. ft.	12 ft.	40 ft.	14 ft.	
	3	100,001 to 240,000 sq. ft.	12 ft.	40 ft.	14 ft.	

facilities ■ Mining and natural resource extraction <u>Use:</u> ■ Motor vehicle and manufactured dwelling and trailer sales; ■ Motor vehicle services ■ Taxicabs and car services ■ Heavy vehicle and trailer sales ■ Heavy vehicle and trailer service and storage ■ Governmental maintenance services and construction ■ Detention facilities ■ Military installations ■ Building and grounds services and construction contracting ■ Cleaning plants ■ Industrial services ■ Drinking water treatment ■ Power generation facilities ■ Data center	5	240,001 to 320,000 sq. ft.	12 ft.	40 ft.	14 ft.	
	6	320,001 to 400,000 sq. ft.	12 ft.	40 ft.	14 ft.	
	7	400,000 to 490,000 sq. ft.	12 ft.	40 ft.	14 ft.	
	8	490,001 to 580,000 sq. ft.	12 ft.	40 ft.	14 ft.	
	9	580,001 to 670,000 sq. ft.	12 ft.	40 ft.	14 ft.	
	10	670,001 to 760,000 sq.	12 ft.	40 ft.	14 ft.	
	Additional Spaces Required	Buildings greater than 760,000 sq. ft.	12 ft.	40 ft.	14 ft.	For each additional 100,000 square feet, or any portion thereof, of building area over 760,000 sq. ft., 1 additional loading space is required.

facilities ■ Fuel dealers ■ Waste-related facilities						
<p>(1) Unless otherwise provided, when required loading is expressed in terms of a number of spaces per a square footage, the square footage shall equal the gross floor area.</p>						

- (a) *Off-street parking used for loading.* An off-street parking area meeting the requirements of this chapter may be used in place of a required off-street loading space when the use or activity does not require a delivery vehicle which exceeds a maximum combined vehicle and load rating of 8,000 pounds and the off-street parking area is located within 25 feet of the building or the use or activity that it serves.